

МИНИСТЕРСТВО ОБРАЗОВАНИЯ И НАУКИ РОССИЙСКОЙ ФЕДЕРАЦИИ
Федеральное государственное бюджетное образовательное учреждение
высшего профессионального образования

**«НАЦИОНАЛЬНЫЙ ИССЛЕДОВАТЕЛЬСКИЙ
ТОМСКИЙ ПОЛИТЕХНИЧЕСКИЙ УНИВЕРСИТЕТ»**

**МЕТОДОЛОГИЯ ПРОЕКТИРОВАНИЯ
МОЛОДЕЖНОГО НАУЧНО-
ИННОВАЦИОННОГО ПРОСТРАНСТВА
КАК ОСНОВА ПОДГОТОВКИ
СОВРЕМЕННОГО ИНЖЕНЕРА**

Сборник научных трудов
Международной молодежной научной школы

02 по 04 апреля 2014г.

**STRATEGY DESIGN OF YOUTH SCIENCE
AND INNOVATION ENVIRONMENT FOR
MODERN ENGINEER TRAINING**

PROCEEDINGS
02 - 04 APRIL, 2014
Tomsk, Russian Federation

Томск
2014

УДК 378.147.88:001.892-057.875
ББК Ч214(2)73
М545

М545 **Методология проектирования молодежного научно-инновационного пространства как основа подготовки современного инженера** [Электронный ресурс]: Сборник научных трудов Международной молодежной научной школы. Россия, Томск, 02-04 апреля 2014 г. / Электрон. текст. дан. (8,81 МБ). – Национальный Исследовательский Томский политехнический университет, 2014. – Режим доступа: <http://portal.tpu.ru/science/konf/mps/digest> – 259 с. – PDF-формат, – Систем треб. AdobeAcrobat 6.0 и выше.

Сборник содержит труды участников Международной молодежной научной школы «Методология проектирования молодежного научно-инновационного пространства как основа подготовки современного инженера». Включает материалы семинара, мастер-класса, доклады студентов и молодых ученых, представленные на секциях «Развитие энергоэффективных технологий как залог повышения экономического потенциала страны», «Единство традиций и инноваций как основа развития современной инженерной науки», «Инновационные тенденции модернизации инженерного дела в условиях глобализации». Сборник представляет интерес для студентов, аспирантов, молодых ученых, преподавателей в области естественных наук.

УДК 378.147.88:001.892-057.875
ББК Ч214(2)73

Научная школа организована при финансовой поддержке
Российского Фонда Фундаментальных Исследований

Редакционная коллегия

В.В. Верхотурова, кандидат исторических наук, доцент;
Ю.В. Фалькович, кандидат педагогических наук;
Н.В. Данейкина, старший преподаватель;
Ю.Н. Шиц, старший преподаватель;
К.В. Карпачева, старший преподаватель;
А.А. Дерюгина, преподаватель.

© ФГБОУ ВПО НИ ТПУ, 2014
© Томский политехнический университет,
электронный текст, 2014

СОДЕРЖАНИЕ

**СЕМНАНН П. NUCLEAR TECHNOLOGIES AS INTEGRAL PART OF ENGINEERING SCIENCE
IN THE MODERN WORLD**

NUCLEAR SAFETY AND NUCLEAR ENERGY DEVELOPMENTS	
L.V. Aleksandrova.....	7
TUNGSTEN PRODUCTION TECHNOLOGY FROM LOW-GRADE TUNGSTEN-CONTAINING MATERIALS	
D.D. Amanbayev	13
RENEWABLE RESOURCES AS ENERGY-EFFICIENT SOURCES	
S.V. Belyavsky, N.O. Pimenov.....	18
TRANSMUTATION OF RADIOACTIVE WASTE	
V. Chulikov, A. Pauls, V. Savchenko.....	22
DEVELOPING A MODEL OF THE COMBINE TYPE MACHINE	
A.A. Deriglazov.....	26
PLASMA-CHEMICAL DISSOCIATION OF HYDROGEN SULFIDE	
D.S. Filatov, S.A. Rakhmanov.....	32
DEVELOPMENT OF THORIUM-CONTAINING NUCLEAR FUEL CYCLE	
I.M. Gubaydulin, S.V. Bedenko	37
ENERGY OF THE FUTURE: NUCLEAR VS OTHER SOURCES	
D.O. Kondratjev, M.P. Gritsevich	43
TECHNOLOGY OF PROCRESSING URANIUM HEXAFLUORIDE USING TO AMMONIUM FLUORIDE	
E.I. Kurchenko.....	46
PRODUCTION OF MOLECULAR COMPOSITES BASED ON POLYTETRAFLUROETHYLENE AND TITANIUM DIOXIDE	
A.L. Lashtur.....	51
PARAMETERS OF PLUTONIUM-THORIUM FUEL CYCLFUEL ELEMENTS OF HYDROGEN POWER INDUSTRY AS A SOURCE OF EFFECTIVE ENERGYE BASED ON SERIAL VVER-1000	
M.V. Nikolaev, A.K. Kushebina, A.Y. Fedotkin.....	55
FAST REACTOR BREST-300	
A.E. Novoselov, E.V. Stolov, V.S. Nefedov	61
OBTAINING OF NANOPARTICLES OF CDS BY PHOTOLYSIS OF NA4[CD(S2O3)3] AQUEOUS SOLUTIONS	
K.V. Obmuch	65
ION-EXCHANGE PROCESSES UNDER THE INFLUENSE OF MAGNETIC FIELD	
S.V. Perminov, E.V. Bospala	71
EVALUATION OF THE EFFICIENCY OF SLUDGE LIGNIN PLASMA DISPOSAL PROCESS	
K.G. Piunova	75
GENERATOR ANALOG AND DIGITAL SIGNALS	
A.S. Popov	79
PRODUCTION OF SOLAR SILICON FOR MANUFACTURING PHOTOELECTRIC CONVERTERS AS A WAY TO INCREASE THE ECONOMIC POTENTIAL OF THE COUNTRY	
D.S. Prakht, M. F. Dzhabbarova	84

ENERGY EFFICIENCY DEVELOPMENT	
S. Seitkazi, K. Kuprin	89
PROSPECTS OF THE USE OF FAST NEUTRON REACTORS	
D.A.Serikov	93
THERMONUCLEAR ENERGY IS A FUTURE SOURCE OF ENERGY	
A.A. Sheveleva, E.V. Lemza, M.A. Doroshenko	98
SYNTHESIS OF HIGH-PURE TITANIUM CONCENTRATES BY THE ELECTROLYTIC METHOD FROM FLUORIDE MELTS	
E.V. Sorokina, K.O. Kovzel	103
ALKALINE AND ALKALINE-EARTH METALS FLUOROHALOGENATES IN ORGANIC SYNTHESIS	
V.D. Suprunenko, V.I. Sobolev	111
RESEARCH OF ION EXCHANGE RESINS CAPACITY IN EXTERNAL CONSTANT MAGNETIC FIELD	
N.V. Tundeshev	114
METHODS OF DETERMINING THE CONTENT OF POLLUTANTS IN THE COMBUSTION PRODUCTS OF PLASMA WATER AND ORGANIC COMPOSITIONS OF THE REACTOR PORTABLE GAS ANALYZER «QUINTOX» KM9106	
E.A. Tyudelekov	118
DEVELOPMENT OF ENERGY-EFFICIENT TECHNOLOGIES	
V.C. Zaytsev	121
СЕМНАП 2. INTEGRITY OF TRADITIONS AND INNOVATIONS AS THE BASIS FOR THE DEVELOPMENT OF MODERN ENGINEERING SCIENCE	
METHODOLOGY OF IDENTIFYING CRITICAL OBJECTS OF INFRASTRUCTURE	
S.D. Babkin, V.V. Kiriyyenko	126
GRAVITATIONAL FUSION REACTOR. CONCEPT AND PERSPECTIVE	
A.Y. Borodai, R.V. Gizbreht	131
DETERMINATION OF NUCLEAR MATERIALS' ELEMENTAL COMPOSITION FOR THE NEEDS OF NUCLEAR FORENSICS	
D.O. Dolmatov	135
METHODS OF MECHANICAL GRINDING AND DISPERSION ANALYSIS OF SOLIDS	
S.V. Inozemtsev, A.A. Malik	140
NUCLEAR ROCKET ENGINE	
A.D. Isakov, A.A. Prozorov, E.P. Shutova	143
POLARIZING RADIATION FROM TARGETS WITH FINITE SIZES	
D.B. Kalitvintsev	149
FUNDAMENTALS AND APPLICATION OF MICROTOMOGRAPHY	
C.V. Keltcieva	154
STUDY OF THE DEFECT STRUCTURE'S EVOLUTION OF THE TITANIUM ALLOY VT1-0 AFTER THERMOHYDROGEN CYCLING BY POSITRON ANNIHILATION SPECTROSCOPY	
O.V. Khusaeva, U.S. Bordulev, V.N. Kudiyarov	160
MULTIGROUP METHOD FOR CALCULATING THE SPECTRUM OF THE NEUTRON FLUX DENSITY OF RBMK-1000	
I.N. Kryvtsov, A.M. Mochalov	164

DEVELOPMENT OF PULSE OXIMETRY FOR APPLICATION IN MEDICINE	
N.I. Martemyanova	167
APPLICATION OF CONFLICTOLOGY METHODS FOR EVALUATING PHYSICAL PROTECTION SYSTEMS EFFECTIVENESS	
M.S. Parepko, A.V. Godovykh, B.P. Stepanov	169
PARAMETERIZATION OF THE TURBULENT DIFFUSION COEFFICIENT OF INDUSTRIAL EMISSIONS	
E.A. Pokrovskaya, V.O. Babicheva.....	172
NONLOCAL ONE-DIMENSIONAL FISHER–KOLMOGOROV–PETROVSKII–PISKUNOV EQUATION WITH ABNORMAL DIFFUSION	
A.A. Prozorov, A.D. Isakov.....	176
SOLAR ENERGY	
M.P. Pustovalova	182
CALCULATION OF ENERGY RELEASE FUNCTION OF FOCUSED ION BEAM IN SOLIDS	
X.S. Ryabkina.....	185
INFLUENCE OF THERMOPHYSICAL PROPERTIES OF THE SOLID DEPENDENCE FROM TEMPERATURE ON THE THERMAL CHARACTERISTICS AND EROSION UNDER THE ACTION OF HIGH-POWER PULSED ION BEAMS	
R.P.Truntseva	190
СЕМНАР 3. INNOVATIVE TRENDS FOR MODERNIZING ENGINEERING IN THE AGE OF GLOBALIZATION	
EXTRACTION OF THE THERMONUCLEAR ENERGY	
A.A.Bulavinov, A.A.Serenko.....	195
DETERMINATION OF OPTIMAL CONDITIONS THE PHASE TRANSITION FOR INDUSTRIAL UNIT FOR PRODUCTION OF TUNGSTEN HEXAFLUORIDE	
S.V.Chernigovskiy.....	199
STUDYING OF MORPHOLOGY AND ELEMENTAL COMPOSITION OF THE CALCIUM PHOSPHATE LAYER AFTER TREATMENT BY IMPULSE ELECTRON BEAM.	
E.A. Chudinova, M.A. Surmeneva, I.YU. Grubova, N.S. Pushilina, A.D. Teresov.....	205
DEVELOPMENT OF DYNAMIC, SPACE DISTRIBUTED MATHEMATICAL MODEL OF DCT OF PRODUCTION URANIUM HEXAFLUORIDE AND THE FURTHER MODELING OF PROCESS	
S.P. Golubev	209
SELF-PROPAGATING HIGH-TEMPERATURE SYNTHESIS	
S.S Guralev, A.A. Grishin	215
THE ACTIVATED CHARCOAL ADSORPTION OF PHENOL	
M.E. Kondrashin, K.A. Solovyova, E.A. Tsareva	225
CALCULATING METHODS OF THE POLARIZATION RADIATION CHARACTERISTICS	
E.V. Kornoukhova	230
THE IMPLEMENTATION OF TCP/IP STACK AT THE LABORATORY DEVELOPMENT BOARD SDK 2.0	
R.A. Nurmuhametov, A.N. Pushinskaya, T.S. Chernyaeva	235
NUCLEAR SECURITY CULTURE	
M.V.Perminova.....	238
APPLICATION OF THE PROGRAMMABLE LOGIC CONTROLLER GLOFA-GM7 IN INDUSTRY	
A.O. Pletnev, D.S. Fedorov	243

THE MODIFICATION OF POLYTETRAFLUOROETHYLENE SURFACE USING HYDROXYAPATITE COATING DEPOSITED BY RF-MAGNETRON METHOD	
T. S. Pryamushko, I.Yu. Grubova, R.O. Banin.....	247
NEW TRENDS IN GLOBALIZATION OF SCIENCE AND ENGINEERING EDUCATION	
N.D. Turgunova	254
APPLICATION OF THE VEGA-2 PROGRAM DURING CONSTRUCTION OF EFFECTIVE SECURITY SYSTEMS	
Y.S.Vahrusheva.....	257

СЕМНАР
***NUCLEAR TECHNOLOGIES AS INTEGRAL PART OF ENGINEERING SCIENCE
IN THE MODERN WORLD***

NUCLEAR SAFETY AND NUCLEAR ENERGY DEVELOPMENT

L.V. Aleksandrova

Scientific Supervisor: PhD, Associate professor D.S. Isachenko

Language Advisor: PhD, Associate professor T.G. Petrashova

Tomsk Polytechnic University, Lenin str., 30, Tomsk, Russia, 634050

E-mail: poman@tpu.ru

Annotation

In this article the issues of nuclear power, expansion and hindrances of its development are considered. The study of «energy pattern» has allowed to make the following conclusions. For the development of nuclear power it is necessary to provide a decrease in risk factors, enhance security and safety to protect staff, population and environment against undue radiological hazards and their consequences.

Introduction

Nuclear energy also refers to the energy sector using nuclear energy for district heating and electrification. In this science field and technology are developed and used in practice, methods and means of conversion of nuclear energy into heat and electricity. Nuclear power plants constitute the basis of nuclear power. Increased use of nuclear technology requires enhanced security and control of the materials used, hence it is a need to create such a system of control, which could provide a full accounting and control over the use of nuclear materials and prevent nuclear proliferation, terrorism and any radiological risks.

Status of nuclear power in the world

Today, more than 60 countries have informed the International Atomic Energy Agency (IAEA) that they are considering starting a nuclear power program and using nuclear power as one of the options to meet their energy needs.

IAEA plays an important role in the wide use of atomic energy to peace and security throughout the world. [1].

A commitment to nuclear power requires perspectives spanning decades and even centuries. Nevertheless, several trends may affect the expansion and direction of nuclear energy in the 21st century. Three main issues affect the future of nuclear power:

- growth of nuclear power;
- availability of future nuclear technologies;
- changes in other energy and industrial sectors.

Development of nuclear energy is not uniform throughout the world and the technical solutions are different. The biggest growth is now concentrated in a few countries with a large population and energy

demand (China and India), some other countries are developing in this area at a slower pace (Republic of Korea, Japan, Russia, Finland, etc.) [1].

Many states have given priority to continued operation of nuclear power plants, which are intended to be used 30 - 40 years. Out of 436 operating nuclear power plants, 327 are in operation for more than 20 years (data July 2008). Need for engineering support in the operation, maintenance, consideration of safety, training and education are becoming increasingly apparent [1].

Nuclear power production has increased significantly since 1990, an increase from 1909 TWh in 1990 to 2.62 trillion kilowatt-hours in 2010, while its share in total electricity production declined from 16.8 % to 13.5 % (USEIA, 2012). There are 436 commercial nuclear power reactors operating in 30 countries around the world with a capacity of 370,000 MW, and 61 reactors with capacity 58,000 MW under construction in 13 countries (IAEA, 2012). Although three-quarters of operating reactors in developed countries, the majority of reactors under construction are in developing countries. China and India have plans to build about 100 reactors over the next 25 years. In addition, 45 new countries have plans to build nuclear power plants in the next two decades (WNA, 2012). This growth was by led a number of factors: the expectation of global primary energy shortages, rising energy prices, environmental problems [2].

Nuclear Weapons Nonproliferation

With the development of nuclear energy, there was a use threat of nuclear waste and materials for nuclear weapons.

Nuclear weapons can be built only if enough weapon-usable nuclear material is available. The weapon-usable nuclear materials include all isotopes capable of being assembled into a fast critical mass which then undergoes explosive prompt fission reactions. These include all isotopes of plutonium, uranium-233,235, neptunium-237, protactinium-231, americium-241,243, curium-244,245,246, berkelium-247, and californium-251.[3]

Plutonium-239, uranium-235, and uranium-233 are most commonly used as nuclear weapon materials. Uranium-235 or uranium-233 can be implemented into a gun-type design, for which the assembly is rather simplistic and weapon testing is not a requirement for efficacy verification. Use of plutonium-239 requires an implosion-type design which demands sophistication in the skills and knowledge of the bomb designer and testing for verification. [3]

Acquiring nuclear weapon-usable material can be pursued in three different ways [3]:

- enrichment of uranium-235 to weapon-grade concentrations using isotope separation;
- chemical reprocessing of spent fuel from reactors to extract plutonium-239, uranium-233, or other weapon-usable fissile materials;
- diversion, theft, seizure, purchase, or receipt of fissile nuclear materials.

The modern nuclear scientists and engineers have enough skills and knowledge to work in civil nuclear power plants and to create nuclear weapon-usable material or nuclear weapons. Civilian nuclear power program can potentially be linked to all of these ways if uranium enrichment or spent fuel reprocessing is involved. Proliferation takes place when the fissile materials from the civilian nuclear power

program are diverted and know how nuclides from the civilian nuclear programs is used for military purposes. Continued accumulations of plutonium in spent fuel and of separated plutonium resulting from reprocessing can be perceived as increasing the proliferation risk associated with the global expansion of nuclear energy. [3]

As for 2004, the world has accumulated 1450 tons of plutonium as global stockpiles. Among this, 250 tons of plutonium were produced at weapon factories. One hundred and ninety-five metric tons of plutonium have been separated from spent nuclear fuel from the civilian reactors. [3]

Higher quality weapon material can be obtained by dedicated way using military reactor. Except for the early nuclear weapons states such as the U.S., Soviet Union, U.K. and China where weapon programs predated civil applications, most of the states with nuclear ambition have used civilian nuclear power programs as cover for any on-going weapons work. The list of these countries includes France, Brazil, South Africa, Argentina, South Korea, North Korea, Taiwan, Pakistan, India, and Israel. [3]

Most countries owning nuclear power technology have drawn clear physical boundaries between military and civilian nuclear programs. Developing civilian nuclear capability does not bear direct relationship with nuclear weapon development. But civilian nuclear capability can provide a cover for clandestine weapon development work. As long as political ambition for nuclear ambition exists, driven by security concerns, a civilian nuclear power establishment provides necessary tools for nuclear proliferation. [3]

In this connection, it is necessary to monitor and control for what purposes nuclear technology is used. Development control methods, which will facilitate the evaluation nuclear weapons non-proliferation, is an important research for the effective use of nuclear power.

To comply the use of nuclear technology for peaceful purposes the Non-Proliferation Treaty (NPT) was created by the UN Committee on Disarmament in 1970 in order to provide necessary international security [4].

The treaty establishes that a nuclear weapon State is one which has manufactured and exploded a nuclear weapon or other nuclear explosive device prior to 1 January, 1967 (i.e. the USSR, USA, UK, France and China).

Each nuclear-weapon State Party to the Treaty undertakes not to transfer to any recipient whatsoever nuclear weapons or other nuclear explosive devices or control over such weapons or explosive devices directly, or indirectly; and not in any way to assist, encourage, or induce any non-nuclear-weapon State to manufacture or otherwise acquire nuclear weapons or other nuclear explosive devices, or control over such weapons or explosive devices.

Each non-nuclear-weapon State Party to the Treaty undertakes not to receive the transfer from any transferor whatsoever of nuclear weapons or other nuclear explosive devices or of control over such weapons or explosive devices directly, or indirectly; not to manufacture or otherwise acquire nuclear weapons or other nuclear explosive devices; and not to seek or receive any assistance in the manufacture of nuclear weapons or other nuclear explosive devices.

All the Parties to the Treaty undertake to facilitate, and have the right to participate in. the fullest possible exchange of equipment, materials and scientific and technological information for the peaceful uses of nuclear energy. Parties to the Treaty in a position to do so shall also cooperate in contributing alone or together with other States or international organizations to the further development of the applications of nuclear energy for peaceful purposes, especially in the territories of non-nuclear-weapon States Party to the Treaty, with due consideration for the needs of the developing areas of the world.

After creating the NPT a number of treaties and agreements were created, which became an international system of security over the proliferation. These treaties include all measures necessary to ensure safeguards against nuclear weapons, materials and technology to ensure the physical protection.

Nuclear safety and nuclear security

The occurred accidents at Three Mile Island, Chernobyl and Fukushima attracted considerable public attention and shook the prospects for the development of nuclear power. Switzerland, Germany and Italy declared renouncing nuclear program, China suspended projects for nuclear power plants, and Japan closed some nuclear power plants. This led to a reassessment of the role of nuclear power in their future energy plans in many countries. [5]

The aim now is to convince the public of nuclear power safety. Therefore it is necessary to strengthen and maintain the effectiveness of radiation protection at nuclear power plants in order to protect workers, the public and the environment from radioactive influence, i.e. comprehensively develop and improve nuclear safety.

The aim is to protect the population and the environment from undue radiological consequences. Risks associated with the nuclear facility must be associated with nuclear safety and security. According to the definition of the IAEA, nuclear safety is to achieve proper operating conditions, prevention of accidents or reduction of the consequences of accident, leading to protection of workers, the public and the environment from radioactive influence and dangers. [6].

Nuclear safety has two complementary aims: radiation protection, the aim of which is to ensure the protection of personnel, health and environmental safety, technical safety, responsible for preventing failures or accidents nuclear facilities, consideration of all possible accidents with their radiological consequences. The aim of creation nuclear security is monitoring and prevention of risks associated with the operation of nuclear power plants. [5]

Safety in the nuclear industry is a very serious issue. The main problem of nuclear safety is a radiological threat posed to humans and the environment. Human factors, equipment failure, internal factors (fire, breaking pipes, etc.) or external factors (such as earthquake, flood or other natural disasters) are main sources accidents.

Nuclear security in turn, focuses on two major unforeseen situations: nuclear terrorism and theft or illicit transfer of radioactive materials. Accidents related to nuclear safety are unintentional, while incidents associated with nuclear security expressly planned and made with a certain aim.

Nuclear safety and nuclear security can contradict each other: nuclear safety culture promotes

transparency and openness, culture nuclear security requires confidentiality. Well-developed safety culture requires employees to share information freely, but the security culture adheres to that, they share information only with appropriate working staff. Security culture and safety should not be combined, and yet they do not conflict with each other.

For emergency response in case of nuclear danger, it is required that the ambulances would have full access to all areas, from the security - no. Safety measures should be developed and implemented in an integrated manner, so that their implementation does not jeopardize the security and vice versa. It is therefore necessary to consider the interaction between the safety and security to eliminate conflicts between them at the design stage, the construction and dismantling of any nuclear power plant [6]

Conclusion

Development of nuclear energy is a big challenge and problems in its safe use. This is reliability and economic efficiency, waste, accidents leading to environmental and technological disasters as well as the purpose of nuclear materials use.

For the development of nuclear power is necessary to reduce risk, improve security in order to eliminate severe accidents similar to Chernobyl, Fukushima nuclear power plant Three Mile Island and control over the use of nuclear materials.

To meet these requirements, the nuclear power plants are equipped with plenty of protection and containment security, multi-level security barrier protection system, which is calculated as the probabilities of severe accidents and the severity of their consequences [7].

References

1. Omoto, A. (2009, September). NENP's activities to support new countries. nuclear power newsletter, Volume 6, No. 3. Retrieved November 15, 2013, from <http://www-pub.iaea.org/MTCD/Publications/PDF/Newsletters/NENP-06-03.pdf>
2. Srinivasan, T.N., Gopi Rethinaraj, T.S. (2013, January). Fukushima and thereafter: reassessment of risks of nuclear power. Original research article energy policy, Volume 52, Pages 726-736. Retrieved December 16, 2013, from <http://www.sciencedirect.com/science/article/pii/S0301421512009172>
3. Man-Sung Yim. (2006, August) . Nuclear nonproliferation and the future expansion of nuclear power. Original research article progress in nuclear energy, Volume 48, Pages 504-524. Retrieved February 25, 2014, from <http://www.sciencedirect.com/science/article/pii/S014919700500209X>
4. Eun-ha Kwon, Won Il Ko. (2009, July). Evaluation method of nuclear nonproliferation credibility. Original research article annals of nuclear energy, Volume 36, Issue 7, Pages 910-916. Retrieved February 25, 2014, from <http://www.sciencedirect.com/science/article/pii/S0306454909001030>
5. Li Chao-jun, Zhang Chun-ming, Chen Yan, Zuo Jia-xu, Chen Jia-yun. (2013). The study on safety goals and public acceptance of nuclear power. Original research article. Energy procedia, Volume 39, Pages 415-422. Retrieved December 16, 2013, from <http://www.sciencedirect.com/science/article/pii/S1876610213013179#>

6. Gandhi, S., Kang, J. (2013, October). Nuclear safety and nuclear security synergy. Original research article. Annals of nuclear energy, Volume 60, Pages 357-361. Retrieved November 15, 2013, from <http://www.sciencedirect.com/science/article/pii/S0306454913002478>
7. Vitazkova J., Cazzoli E. (2013, September). Common risk target for severe accidents of nuclear power plants based on IAEA INES scale. Review article. Nuclear engineering and design, Volume 262, Pages 106-125. Retrieved December 16, 2013, from <http://www.sciencedirect.com/science/article/pii/S0029549313002136#>

TUNGSTEN PRODUCTION TECHNOLOGY FROM LOW-GRADE TUNGSTEN-CONTAINING MATERIALS

D.D. Amanbayev

Scientific Supervisor: Assistant S.N. Chegrintsev

Tomsk Polytechnic University, Russia, Tomsk, Lenin str., 30, 634050

E-mail: daleramanbayev@gmail.com

Annotation

Tungsten is a worldwide highly-consumed metal. As the tungsten price has increased substantially in the last decade there is an economic imperative to recycle it. It is suggested to involve tungsten-containing metallurgical slags and wastes in reprocessing. Extraction of 87 % of tungsten into solution was reached by autoclave pressure leaching with sodium carbonate (250 g/l) as a leaching agent. Temperature of the process is 220-230 °C, solid-to-liquid ratio – 1:5, stirring rate – 60 rpm, duration – 6 hours. After liquor purification from sulfur and silicon by flocculating agent VPK-402, ion-exchange extraction of tungstate-ion was carried out. Sorption properties of two anion-exchange resins – Amberjet 4200 and AV-17-8 – were studied in static conditions. It was revealed that strongly basic anion-exchange resin AV-17-8 in chloride-form is more capable of tungsten in comparison with Amberjet 4200: 42,5 kilos of W/m³ against 32 kilos of W/m³. Carbonate-ions showed a greater affinity to the resin than tungstate-ions, therefore ion-exchange stage was performed in two steps: 1 – to remove CO₃²⁻ from liquor, 2 – extract WO₄²⁻. Desorption was implemented by NH₄Cl (50 g/l) with solid-to-liquid ratio 2,5:1 yielding ammonium paratungstate (NH₄)₂WO₄ (APT). Technology steps for production pure tungsten powder from APT through WO₃ are well-known and described briefly.

Key words: tungsten, market, wastes reprocessing, technology, autoclave leaching, ion-exchange, desorption, ammonium paratungstate, metallic powder.

Research field: chemical technology of rare elements.

Related sciences: chemistry, material sciences, Earth sciences.

Introduction

Since 19-th century tungsten has been widely used in different fields of industry e. g. tungsten steels for panzer armor, torpedoes' shell, and airplanes' parts; its carbides and borides are known for their solidity and used as material for edge-tools; and of course tungsten is irreplaceable material for a glower of electrical lamp due to its incredibly high melting point 3422 °C. Another tungsten's important properties are very high density 19,25 kg/m³, extreme hardness 488 kg/mm², high wear resistance, high tensile strength, low coefficient of expansion and high thermal and electrical conductivity. These unique parameters make tungsten strongly sought-for, therefore its consumption is showing relatively constant growth [1-3]. The metal's output almost doubled in almost 30 years from 25 000 tons per year in 1980 to slightly over 50 000 tons per year in 2008. In spite of steep drop in demand in 2008-2009 which affected every metal's market, output of tungsten is on its increase now with an average growth rate of 4,7 % per year [4].

Solutions that have been proposed to overcome the shortage of the metal consist in extensive enlargement of mining fields – development of new tungsten deposits – and intensive improvements of existing technologies – involve low-grade ores and wastes that were considered to be unreasonable to use. Generally, the first way (new deposits) is a lot more expensive than the second as it consists of mining works and technology development whereas intensive way includes only costs for researches in technology.

Existing technologies that are widely used in industry were designed to produce tungsten from ores with an average metal's concentration at least 5-10 %. The richest ones are situated in China, Republic of Korea, Burma, USA, Spain and Portugal [5]. Russia is represented by Caucasus, Ural and Trans-Baikal deposits containing as low as 4 % of tungsten [6, 7]. All the researches and technologies of tungsten processing have been carried out in sixties and don't meet contemporary issues, thus there is still a lot to be rediscovered.

A modern technology was suggested by a group of scientists from Tomsk Polytechnic University (fig. 1) [8]. The major steps of it are pressure soda leaching of tungsten scrap, extraction W from liquor to water by ion-exchange sorption and desorption yielding ammonium paratungstate (APT) with its, drying, heat-treatment with WO_3 formation and its reduction to W powder by hydrogen.

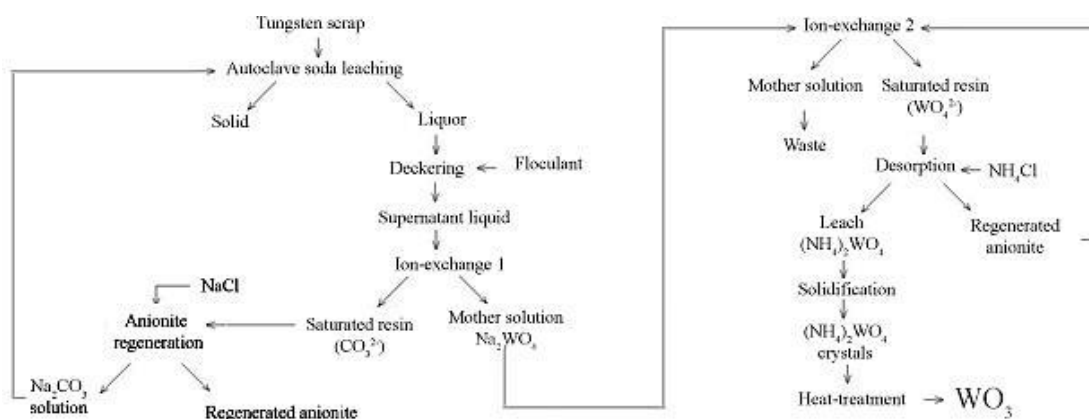

Fig. 1. Technology of tungsten production from low-grade ores and scrap.

This paper is dedicated to explore optimal conditions under which soda leaching and sorption-desorption operations are about to be carried out with highest yield of W and the lowest costs. Therefore the objectives of this research are to determine:

1. Concentration of leaching agent – Na_2CO_3 ;
2. Solid-to-liquid ratio in leaching process;
3. Duration of leaching process;
4. Stirring rate;
5. Type of ion-exchange resin;
6. Solid-to-liquid ratio in sorption process;
7. Form of mobile ion with the highest exchange capacity on W;
8. The effect of impurities;
9. Ability of ammonium chloride to desorb tungstate-ion from the resin;

10. Solid-to-liquid ratio in desorption process;

Methodology

Pressure leaching. The leaching was implemented in autoclave:

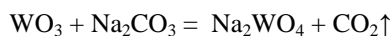

Under the temperature of 225 °C a series of experiments was carried out with the concentration of Na₂CO₃ as a variable. The correspondence between sodium carbonate **m** and degree of extraction **α** is given in table 1.

Table 1. Concentration of leaching agent Na₂CO₃ study.

m (Na₂CO₃), g	75	125	200	250
α_w, %	40	55	76	84

It is clear that 250 g/l of leaching agent gives the best degree of tungsten's extraction.

The next parameter to identify is solid-to-liquid ratio. For that purposes three samples of leaching mixture were prepared with the ratio 1:2, 1:3 and 1:5. Reaction had been carried out for 8 hours under constant stirring (fig. 2).

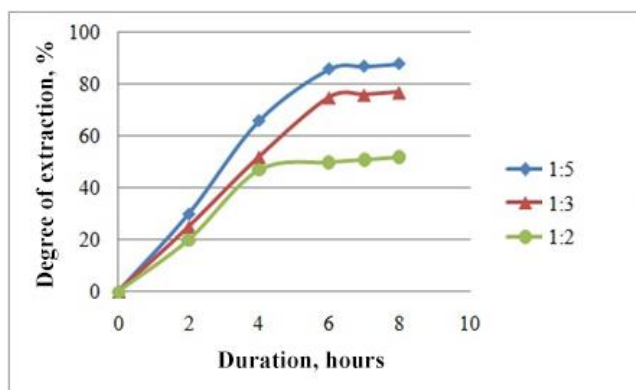
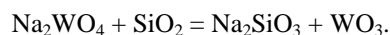

Fig. 2. Solid-to-liquid ratio in leaching process.

As it can be seen from the graph hereinbefore, 1:5 ratio results better extraction of tungsten than the other two options. Moreover implementing soda pressure leaching longer than 6 hours doesn't make sense as the curve achieves plateau and leaching inhibits.

Varying the stirring rate from 0 to 1500 it was revealed that degree of W extraction peaks at 60 rpm. Enhancement of stirring rate leads to contraction of tungsten leaching as it may be supposed that tungstate-ion exchanges with silicon oxide moving from liquor back to oxide form:



Finally, 60 rpm stirring was considered to be the most appropriate.

Ion-exchange. To extract WO₄²⁻ from alkaline medium liquor by ion-exchange method two strongly basic anion-exchange resins were explored – Amberjet 4200 and AV-17-8 – as they are sustainable in alkaline medium and produced in large scale nowadays. AV-17-8 demonstrated larger W capacity than Amberjet 4200: 42,5 kg/m³ in contrast to 32 kg/m³ accordingly, consequently all the experiments were implemented with AV-17-8 resin.

Solid-to-liquid ratio in sorption process was determined with 1:2, 1:4, 1:6, 1:8, 1:10 samples under constant conditions with constant stirring of resin and liquor. The correspondence between solid-to-liquid ratio and extraction degree is shown in fig. 3.

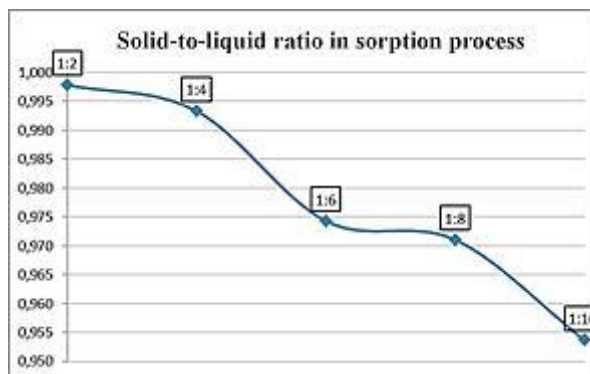

Fig. 3. Solid-to-liquid ratio in sorption process.

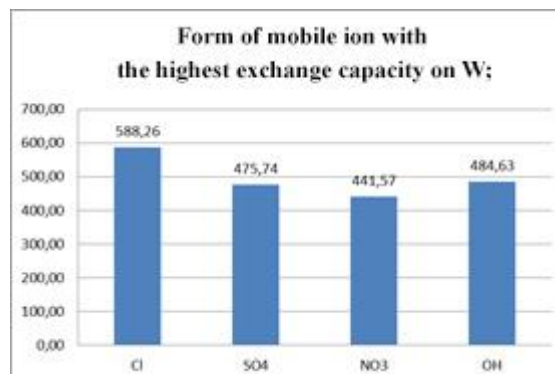
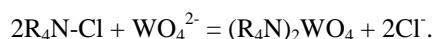

Fig 4. Form of mobile ion.

Though 1:2 ratio achieves the best result, it was decided to choose 1:8 ratio for next steps since difference in extraction degree is insignificant but the costs of 1:2 option exceed ones of 1:8.

Investigation in form of mobile ion with the highest exchange capacity on W was performed on resin charged Cl⁻, OH⁻, NO₃⁻ and SO₄²⁻ ions. As far as it was predicted by the theory of ion-exchange affinity, chlorine-ion reached the highest W capacity – 588,26 kg/m³ of the resin – among others (fig. 4) reacting:



It was determined that carbonate-ion suppresses tungstate-ion sorption as it has more affinity to AV-17-8 resin. Solution lays in two-stage sorption: firstly, CO₃²⁻ ions are removed and secondly, with no interference action, WO₄²⁻ ions are easily extracted. Being sorbed and purified, WO₄²⁻ is ready to be moved to liquid form.

Study of desorption was carried out in static conditions with constant stirring. The first and the very needed desorbent NH₄Cl as it yields ammonium paratungstate and regenerates ion-exchange resin simultaneously:

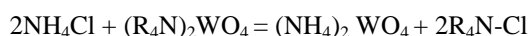

Research resulted that ammonium chloride (50 g/l) removes WO₄²⁻ in great extent, thus it can be used as a desorbing agent in this technology in solid-to-liquid ratio 2,5:1.

Results

1	Concentration of leaching agent – Na ₂ CO ₃	250 g/l
2	Solid-to-liquid ratio in leaching process	1:5
3	Duration of leaching process	6 hours
4	Stirring rate	60 rpm
5	Type of ion-exchange resin	AV-17-8
6	Solid-to-liquid ratio in sorption process	1:8
7	Form of mobile ion with the highest exchange capacity on W	Cl ⁻ (588,26 kg/m ³ of the resin)

8	The effect of impurities	CO_3^{2-} negatively affects sorption of WO_4^{2-} ; two-stage sorption was proposed
9	Ability of ammonium chloride to desorb tungstate-ion	possible
10	Solid-to-liquid ratio in desorption process	2,5:1

Conclusion

Conditions under which soda leaching and sorption-desorption operations are about to be carried out with highest benefits and yield were determined. Research has shown that extraction of 87 % of tungsten into solution can be reached by autoclave pressure leaching with sodium carbonate as a leaching agent. Temperature of the process is 220-230 °C, solid-to-liquid ratio – 1:5, stirring rate – 60 rpm, duration – 6 hours. After liquor purification from sulfur and silicon by flocculating agent VPK-402, ion-exchange extraction of tungstate-ion was carried out. Sorption properties of two anion-exchange resins – Amberjet 4200 and AV-17-8 – were studied in static conditions. It was revealed that strongly basic anion-exchange resin AV-17-8 in chloride-form is more capable of tungsten in comparison with Amberjet 4200: 42,5 kilos of W/m^3 against 32 kilos of W/m^3 . Carbonate-ions showed a greater affinity to the resin than tungstate-ions, therefore ion-exchange stage was performed in two steps: 1 – to remove CO_3^{2-} from liquor, 2 – extract WO_4^{2-} . Desorption was implemented by NH_4Cl (50 g/l) with solid-to-liquid ratio 2,5:1 yielding ammonium paratungstate $(\text{NH}_4)_2\text{WO}_4$ (APT).

References

1. Lassner, E and Schubert, W-D. 1999. Tungsten: properties, chemistry, technology of the element, alloys and chemical compounds. Kluwer Academic/Plenum Publ. New York, 422p.
2. Alderton, D H M. 1993. Mineralisation associated with the Cornubian Granite Batholith. In: Patrick, R A D. & Polya, D A. (Eds.) Mineralisation in the British Isles. Chapman and Hall. London.
3. A.D. Koutsospyros, N. Strigul, W. Braida, C. Christodoulatos. Tungsten: Environmental Pollution and Health Effects. Encyclopedia of Environmental Health, 2011, Pages 418-426.
4. Tungsten Market Overview. The MMTA - minor metal trade association <http://www.mmta.co.uk/tungsten-market-overview>.
5. Cox, D P and Singer, D A. (eds.). 1986. Mineral deposit models: United States Geological Survey Bulletin 1693, 379p.
6. Kindyakov P. S., Korshunov B. G. Himiya i tehnologiya redkih i rasseyannih elementov. Chemical technology of rare and scattered elements. (Visshaya shkola, Moscow, 1976), p 247-248.
7. Zelikman A. N., Nikitina L. S. Volfram. Tungsten (Metallurgiya, Moscow, 1978), p272.
8. Patent RU № 2504592. Sposob polucheniya volframata natriya. Sodium tungstate production technology. Dyachenko A. N. (RU), Kraidenko R. I. (RU), Chegrincev S. N. (RU), Dugel'nyj A. P. (RU).

RENEWABLE RESOURCES AS ENERGY-EFFICIENT SOURCES

S.V. Belyavsky, N.O. Pimenov

Scientific Supervisor: A.O. Semenov

Linguistic Advisor: T.G. Petrashova, PhD

Tomsk Polytechnic University, Russia, Tomsk, Lenin str., 30, 634050

Email: svb28@tpu.ru

Annotation

This article provides the information about the concept of renewable resources as energy-efficient sources, its classification, methods of using, including the most innovative which are realized nowadays. The study offers a comprehensive description of all types of renewable energetic resources, exciting at this moment.

Key words: renewable resource; biomass; wind and solar energy; drilling; reinjection; potable water; irrigation.

Nowadays, people generally use nonrenewable sources of energy because it has been already developed and aspects of this area are studied. Some of them are being under research now. However, it is not effective because we cannot renew them. Therefore scientists try to find the most energy-efficient sources from the renewable ones.

The main purpose of this study is to show that the area of producing energy from renewable resources is actively developing now as well as to have a look at scientists' inventions and future projects.

The term "renewable" is generally applied to those energy resources and technologies whose common characteristic is that they are non-depletable or naturally replenishable.

A.J. Armstrong explains that renewable energy technologies produce power, heat or mechanical energy by converting those resources either to electricity or to motive power. The policy maker concerned with development of the national grid system will focus on those resources that have established themselves commercially and are cost effective for on-grid applications. Such commercial technologies include hydroelectric power, solar energy, fuels derived from biomass, wind energy and geothermal energy. Wave, ocean current, ocean thermal and other technologies that are in the research or early commercial stage, as well as non-electric renewable energy technologies, such as solar water heaters and geothermal heat pumps, are also based on renewable resources. [1]

As concerns resources, they are fundamentally different. At present, the major commercial grid-connected renewable resources are hydroelectric, geothermal, biomass, wind energy and solar. In the majority of legal regimes, hydroelectric and geothermal resources are identified as owned in common by the people of the country and developed by the government for their benefit.

Dr. J. Hamrin suggests the following classification of renewable resources:

- Geothermal resources require extraction (and reinjection). Drilling for geothermal resources involves many of the same discrete considerations involved with drilling for petroleum (hydrocarbons) and individual treatment is prudent.

- Hydroelectric resources are inextricably linked with surface water rights, including potable water, navigation, irrigation, navigation and recreational rights. The historical complexities of sorting out these juxtaposed rights usually dictate individual treatment of hydroelectric resource issues.

- Wind energy and solar draw on resources - wind and sun energy - generally thought of as being free for the taking. The principal resource issue with both of these renewables is surface land. Therefore there is no general technical requirement for individual treatment.

- Biomass is a broadly inclusive term, often encompassing wood and wood waste, agricultural waste and residue, energy crops, and - sometimes - landfill gas resources. Resource availability and cost can be highly variable, and resources may require management of a type not frequently required for other renewables. [1]

According to the recent study presented in the Journal of Environmental Studies, renewable energy technologies are a cost-effective way to provide power. If climate change costs and health impacts are included in the price analysis, wind and solar energy is cheaper than coal-fired power plants. This is in addition to their well-documented effects on carbon pollution. Coal-fired power plants account for 40 percent of the national carbon footprint, according to the study's authors. Switching power generation to clean energy would cut down on this output, which could help slow the effects of global warming.

Large energy companies have traditionally maintained certain renewable energy technologies, such as small-scale solar installations, were too expensive and unwieldy to implement. This has been a persistent excuse for continuing to use coal-fired plants and other methods of energy production that are harmful to the environment and human health. However, more major utilities are learning that distributed generation can save them money. Distributed generation is the practice of using small-scale energy generators, like rooftop solar panels and mini wind-turbines, to produce electricity in close proximity to where it is used. [2]

At the same time, the report states that the cost of gas- and coal-fired plants is increasing because of lower utilization of thermal plants, the higher capital costs of some new thermal plants and the increasing cost of fuel.

Development of renewable energy technologies provides new researching. For example, Rice University scientists have unveiled a revolutionary new technology that uses nanoparticles to convert solar energy directly into steam. The new "solar steam" method from Rice's Laboratory for Nanophotonics is so effective it can even produce steam from icy cold water. The technology's inventors said they expect it will first be used in sanitation and water-purification applications in the developing world.

The technology has an overall energy efficiency of 24 percent. Photovoltaic solar panels, by comparison, typically have overall energy efficiency around 15 percent. However, the inventors of solar steam say that they expect the first uses of the new technology will not be for electricity generation but rather for sanitation and water purification in developing countries.

Moreover, Fitlow J. in his article explains that the efficiency of solar steam is due to the light-capturing nanoparticles that convert sunlight into heat. When submerged in water and exposed to sunlight, the particles heat up so quickly they instantly vaporize water and create steam. The solar steam's overall

energy efficiency can probably be increased as the technology is refined.

Scientists are going from heating water on the macro scale to heating it at the nanoscale. Their particles are very small -- even smaller than a wavelength of light -- which means they have an extremely small surface area to dissipate heat. This intense heating allows them to generate steam locally, right at the surface of the particle, and the idea of generating steam locally is really counterintuitive. [3]

Another potential use could be in powering hybrid air-conditioning and heating systems that run off of sunlight during the day and electricity at night.

Last year, for example, Saudi Arabia's plans to launch a massive renewable energy program were the big news coming out of the Middle East – but internal wranglings have resulted in uncertainty about the future of the project. Looking elsewhere in the region, it appears that Jordan may wind up upstaging its neighbors by pursuing steps to reduce its dependence on imported energy, which currently stands at 97 percent. The plan, which involves the initial procurement of 200 megawatts (MW) of solar energy and 200 MW of wind power, is intended to increase the kingdom's share of renewable energy contributions from one percent to 10 percent by 2020. Round one is primarily being deployed in the southern region of Ma'an. Later stages may prove riskier, as Jordan plans to switch focus to the northern and eastern parts of the country, close to the border with Syria.

Jordan's efforts notwithstanding, Font V. sees Dubai as a key market to watch in 2014. «There are plans to tender the second phase of the Dubai Solar Park in 2014», he says, and «which will be a 100 MW PV independent power project. That's arguably the most important solar project for next year in the Middle East». [4]

One of the biggest challenges facing the future of the solar industry is the ability to provide cost-effective storage. Solar energy's intermittent nature is a fact that many say could prevent more widespread adoption of the technology as a viable replacement for traditional energy generation.

Consequently, countries worldwide try to make solar energy more cost-effective. For example, Latin America could very well someday soon blossom into a world leader in solar energy. By most accounts, industry growth in 2013 was not explosive – but the region did experience significant added.

«There are quite a few countries in South America that have projects and developments in various stages», Font V. claims. «Chile is obviously very important. There's a lot of preliminary project activity going on down there, but also some major projects that plan to be installed during the coming year». Coming in a close second behind Chile as one of the countries most likely to make significant inroads in solar in 2014 is Mexico, which Font V. says has several large scale projects underway. «The third major Latin American market to watch is Brazil», Font V. adds. «That growth is being driven in large part by localities within Brazil, cities and states that are trying to incentivize solar rather than having it take place at the federal level». [4]

Most are of the shared opinion that 2014 will be a year of consolidation. Font V. believes 2014 will draw a «deep line of demarcation between the haves and the have-nots» in that downstream installers who are unable to provide low cost systems will find themselves out of business. «I think the days of subsidizing

high-cost installers will come to an abrupt end next year», he says, tempering this prediction by adding that few employees will experience long term unemployment as a result: «They'll be hired into other companies. That's good news for employees and it is good news for all of us – including governments that are paying subsidies. It's also good for the solar industry at large, because you're going to have much more professional business people running the companies. Ultimately that's also great news for consumers». [4]

In conclusion, it should be stated that renewable energy resources are becoming more cost-effective and energy-efficient now. Worldwide scientists invent modern technologies and try to update the exciting ones. It is believed that renewable resources will be used in future as energy-effective sources.

REFERENCES

1. Armstrong, A. J., Hamrin, J. (1999). The Renewable Energy Policy Manual. Retrieved March 25, 2014, from <http://www.oas.org/dsd/publications/Unit/oea79e/begin.htm#Contents>.
2. Utilities find renewable energy technologies are cost-effective. Retrieved March 25, 2014, from <http://www.bridgebank.com/news/utilities-find-renewable-energy-technologies-are-cost-effective>.
3. Fitlow, J., (2012, November 19). Super-efficient solar-energy technology: 'Solar steam' is so effective; it can make steam from icy cold water. Retrieved March 25, 2014, from <http://www.sciencedaily.com/releases/2012/11/121119140627.html>.
4. Font, V., (2014, February 14). The Solar Energy Outlook for 2014. Retrieved March 25, 2014, from <http://www.renewableenergyworld.com/rea/news/article/2014/02/the-solar-energy-outlook-for-2014>.
5. «Power Engineering» (2013, July 9). Renewable energy technology becoming more cost-effective. Retrieved March 25, 2014, from <http://www.power-eng.com/articles/2013/07/renewable-energy-technology-becoming-more-cost-effective-iea-says.html>.
6. Thaila R., Dhinesh V., Venkatesan C.V., Saravanan S. Design of Full-Bridge Resonant AC-Link Boost Converter using Solar Energy System. IRACST – Engineering Science and Technology: An International Journal (ESTIJ), ISSN: 2250-3498, Vol.2, No. 5, October 2012.

TRANSMUTATION OF RADIOACTIVE WASTE

V.Chulikov, A. Pauls, V. Savchenko

Linguistic Advisor: Teacher A.V. Tsepilova

Tomsk Polytechnic University, Russia, Tomsk, Lenin str., 30, 634050

E-mail: - vladimir666c@gmail.com

Abstract

The present work is devoted to the problem of radioactive waste transmutation, i.e. transformation of long-lived and toxic radionuclides into less toxic isotopes with shorter half-lives. While storage and burial cannot completely prevent radioactivity from getting into the environment, transmutation is a potential way to resolve the problem of radioactive waste. Different types of nuclear transmutation taking place under different conditions are described and analyzed. They include transmutation of long-lived fission products in a neutron field, generation of neutrons for providing transmutation of long-lived fission products, electronuclear method of neutron generation and controlled nuclear fusion. A review of literature devoted to the above-mentioned techniques is done.

Nuclear power is an important developing power source for the future. It represents a pure and effective energy resource. One of pressing problems of nuclear power is the problem of increase of safety of a postreactor fuel cycle where the important place is taken by the problem of dealing with radioactive waste (NW). Storage and burial cannot completely prevent radioactivity from getting into the environment. Only the transmutation can resolve the problem of radioactive waste disposal. Transmutation means transformation of long-lived and toxic radionuclides into less toxic substances with shorter half-lives. The idea is that the program of a transmutation should transform the problem of long-term isolation of NW to the problem waste storage during several tens or hundreds years.

It is known that NW appears at various stages of production: from uranium mining to processing of spent fuel. The NW which appears as a result of spent fuel processing is the most difficult to dispose of. It contains the major part of fission products characterized by high activity, thermal emission and a long period of recession of activity. A characteristic feature of radioactivity is that it can neither be destroyed nor neutralized by chemical methods. It is possible to destroy radioactivity only by nuclear reactions, transferring radioactive isotopes to stable, long-lived or short-lived isotopes, or by destroying the nucleus. Transmutation of all long-lived radionuclides can be considered the most important task. The role of transmutation of long-lived actinides and, to a lesser extent, of the fission products accumulating in reactors, becomes more and more significant in development of fuel cycles, both for modern reactors, and for future nuclear power systems. It will allow to reduce the load on the places of radioactive waste burial or to eliminate the problem of "eternal" burial of the most dangerous long-lived radionuclides.

First of all, let us consider the transmutation of long-lived fission products in a neutron field.

Long-lived radionuclides with high specific activity, which appear when processing spent fuel of nuclear reactors, pose the greatest danger. It is also necessary to take into account the fact that similar highly active waste can appear when processing the spent fuel of electronuclear and thermonuclear facilities with a

subcritical blanket, which are usually called hybrid thermonuclear reactors.

The speed of a transmutation of long-lived fission products in a neutron field does not depend on time and depends on neutron flux density, so with its increase the speed of reduction of nuclide amount also increases. The rate of this recession is characterized by average lifetime of radionuclide in a neutron field. If the neutron flux density is equal to zero, average lifetime of this radionuclide is equal to the half-life period of this nuclide. If the neutron flux density is not equal to zero, average time lifetime of radionuclide is called the effective half-life period of the radionuclide which is in a neutron field. The nature of nuclide amount change in time will depend on entry conditions, i.e. on the moment when transmutation process begins. If the transmutation begins at the moment when in a nuclear system there is such an amount of radionuclide that corresponds to equilibrium value, the time of transmutational process is reduced. The development of such transmutation technique would allow to reach equilibrium state quickly enough. The most important indicators of the efficiency of neutralization of long-lived NW are as follows: average lifetime of the transmuted radionuclide in a neutron field, inevitable losses of radionuclides in a production cycle of transmutation, generation of excess neutrons for transmutation, safety of the transmutational cycle for environment. [1]

The next technique is generation of neutrons for providing transmutation of long-lived fission products. It is necessary to consider critical systems (nuclear reactors).

The critical system is characterized by neutron balance of the self-sustaining chain reaction of fission. It is possible to release neutrons for a transmutation only as a result of redistribution of neutron balance in a chain reaction. If in the future nuclear power is based mainly on fast reactors, secondary fuel will be needed only for replenishing of burning primary fuel, and also for ensuring the development of a nuclear power supply system. Then in fast reactors the part of uranium in screens can be replaced by transmuted long-lived radionuclides, i.e. such a reactor can be considered to be a source of neutrons for transmutation. Transmutational potential of such fast reactor (in case it provides fuel for itself) could make ~ 0,5 neutrons per one act of fission. However, transmutational potential cannot be characterized only by the number of generated excess neutrons. For effective transmutation rather high density neutron flux density is also required. Otherwise, we would have to wait for equilibrium transmutation for centuries. As level of neutron flux in the screen of a fast reactor is connected with flux level in reactor core, the increase in neutron flux density will cause the need to increase the density of energy release in the core, which has restrictions on hydraulics, operability of fuel elements and safety. [2]

Let us now say a few words about the electronuclear method of neutron generation (non-reactor systems).

Electronuclear method of neutron generation is based on the use of nuclear fission reactions of nuclei of heavy elements (Pb, Tb and others), accelerated to high energies (1-1,5 GeV) by protons. The process of interaction of high-energy particles with nuclei has a cascading nature. When a beam of accelerated particles is absorbed by the target, fission reactions with subsequent cascade-evaporation multiplication of neutrons are induced in it. Neutron yield (average number of neutrons emitted from the target per one bombarding

particle) is proportional to the value of the kinetic energy of bombarding particles at the moment of the first inelastic collisions with nuclei of the target. The value of the neutron yield as a result of the cascading process also depends on the target material and its size. Due to the permanent leakage of neutrons and parasitic absorption in construction materials, coolant and moderator lose about 10% of the generated neutrons. The number of neutrons produced in ENI for the needs of transmutation is 0.8 neutrons per fission act. These are additional neutrons in relation to the neutron balance of nuclear energy systems that can be used for transmutation of long-lived NW power reactors. Not all of the additional neutrons can be used for transmutation of long-lived radionuclides because fission energy was used for their obtaining (for power accelerator), which caused the emergence of fission products.

One more technique that could be used as a source of neutrons for transmutations is controlled nuclear fusion.

Controlled nuclear fusion of heavy isotopes of hydrogen is traditionally considered as a power source with almost inexhaustible fuel base. Researches in the field of NF, which have been conducted for nearly half a century, are now at such a stage that the moment of obtaining intensive controlled thermonuclear reaction is quite close.

The simplest way of implementation of thermonuclear reaction is synthesis of deuterium + tritium (fuel D – T) with a positive power output, thus it is accompanied by the emergence of a fast neutron which carries away about 80% of the released energy into the blanket. However, higher plasma temperature is needed to induce a (D – D) reaction. Replenishing of a burnt deuterium (2_1D) doesn't make a problem since its stocks on our planet are almost inexhaustible (0,014% in natural water), and radioactive tritium (3_1T) with ($T_{1/2} = 12.3$ years). Taking into account inevitable losses of neutrons in a blanket due to "parasitic" absorption and leakage of radioactive decay, 1,06 nuclei of tritium is required for one (D – T) – reaction.

Along with (D – T) reaction, reaction between deuterium nuclei (the D-D, monofuel) which proceeds in two channels with approximately identical probability is also considered. Here one neutron and one tritium nucleus appear in on the average two (D-D) – reactions. The tritium nucleus can enter (D – T) - reaction with generation of one more neutron. However, for inducing a (D-D) – reaction a higher temperature of plasma is needed. At the same time in this case it is not required to spend neutrons on tritium production.

An important advantage of a thermonuclear source of neutrons is rather low fraction of thermonuclear capacities which need to be included into a nuclear power supply system. If, for example $\eta_{\text{тр}} = 0,5$ neut./fission act is required for transmutation of long-lived products, then the share of thermonuclear capacities will make about 15% of power of the whole system. If an electronuclear installation (ENI) is used for this purpose, the share of capacities connected with ENI (provision of energy for accelerators), makes more than 60%.

Generation of neutrons in partially catalyzed (DDT) - synthesis is also considered. 0,5 neutrons with $E_v = 2,45$ MEV and 0,5 neutrons with $E_v = 14,1$ MEV will be generated for one reaction due to combustion of tritium formed in the reaction. The rigid component of this neutron source can be multiplied by placing

lead or beryllium behind the first wall. The exit of neutrons for one partially catalyzed (DDT) - reaction (taking into account generation of neutrons in accompanying (D-D) - reaction) will make 1,20.

Although it is less than the neutron output in (D-D) - reactions taking into account reproduction, there is no need to spend neutrons on tritium reproduction. Therefore, if we assume that parasitic absorption is 0,25, then 0.95 neutrons per one partially catalyzed (DDT) – reaction may be used for transmutation. This size is three times greater, than the corresponding generation of neutrons for transmutation by means of (D-D) - synthesis reaction. [3]

CONCLUSION

Due to the large-scale development of nuclear power the problem of processing NW, and its further use became important. In scientific publications various versions of physical solutions concerning implementation of long-lived NW transmutation in both nuclear reactors, and in nuclear installations which haven't been practically implemented (electronuclear and thermonuclear installations) are discussed. Researches on NW transmutation physics will allow to formulate at least conceptual technical requirements to such installations.

Now it can be clearly understood that it is impossible to develop nuclear power of the future with old types of nuclear reactors. It is necessary to develop technologies and designs, such as subcritical nuclear reactors operated by accelerators of charged particles. These systems will allow to eliminate the use of enriched uranium and plutonium and to completely solve the problem of spent nuclear fuel and radioactive waste, to provide non-proliferation of dangerous nuclear materials.

REFERENCES

1. E.O. Adamov, I.H. Ganev, A.V. Lopatkin, V. G. Muratov, V. V. Orlov. (1999). Transmutational fuel cycle in large-scale nuclear power industry of Russia;
2. G. M. Pshakin, N. I. Geraskin, V.A. Apse (2004). Nuclear non-proliferation;
3. V.A. Apse, A.E. Sintsov, A.N. Shmelyov, G.G. Kulikov, V. V. Artisyuk (2001). Radioactive waste: neutralization ways;
4. V.A. Apse, A.N. Shmelyov (2006). Bases of safe handling of radioactive waste;
5. «Development of nuclear power and integrated power systems»: <http://energetika.in.ua/ru/books/book-4/part-1/section-8/8-1>

DEVELOPING A MODEL OF THE COMBINE TYPE MACHINE

A.A. Deriglazov

Scientific Supervisor: Assistant N.S. Krinitsin

Language advisor: Senior teacher N.G. Novikova

Tomsk Polytechnic University, Russia, Tomsk, Lenin str., 30 634050

E-mail: daa424@yandex.ru

Annotation

Currently, nuclear industry has entered a new phase of its development, establishing itself in the world as a reliable and cheap source of electricity.

Fuel consumption in a nuclear industry is increasing every year, which requires an increase in the amount of fuel production and, consequently, increase of production capacity and performance of the nuclear fuel cycle, including sublimation plant (SP) of "Siberian Chemical Combine (SCC)."

Introduction

Today at the SP of "SCC" uranium hexafluoride is produced by direct fluorination of uranium oxides. Block diagram of the uranium hexafluoride production (UHP) is shown in Figure 1.

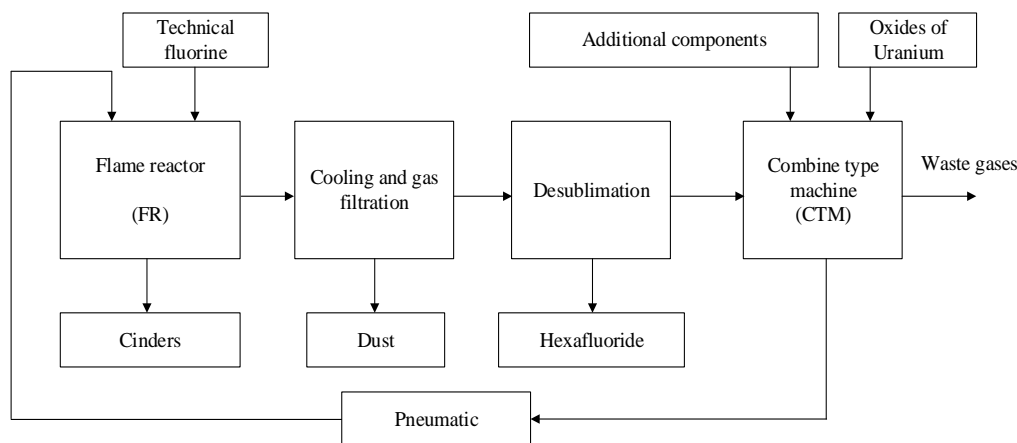

Figure 1 - Block diagram of the production of hexafluoride of uranium (UHP)

Fluorination node which is based on the flame reactor is designed to produce uranium hexafluoride by high uranium fluorination of components coming from the capture node (U_3O_8 , UO_2F_2 and UF_4). Gaseous hexafluoride of uranium which obtained in the flame reactor is transported to the desublimation node where uranium hexafluoride is deposited on the cooling pipes [1].

Next, the process gas enters the CTM, where the capture of valuable components "tail of gas" (F_2 fluorine, hydrogen fluoride, HF, uranium hexafluoride UF_6) on uranium oxide occurs.

Closure of production by solid-phase component provides a pulsed pneumatic, which organizes the overload of necessary elements from CTM to FR's batchers.

Development, methodology

Today consistency of solid-phase components loadings is currently provided in the manual mode. For making automatic control system which can organize automatic calculation of amount of uranium oxide loading in the CTM requires the development of a mathematical model of the horizontal part of the

CTM. This model will produce parametric synthesis algorithm matching loadings in PR machines and ACT.

The analysis of the recorded variables characterizing the amount of components at the input and output of the horizontal part of CTM revealed rotational speed of the transporting screw which is responsible for CTM loadings and value of mass of solid-phase components in chamber feeders (Fig. 2).

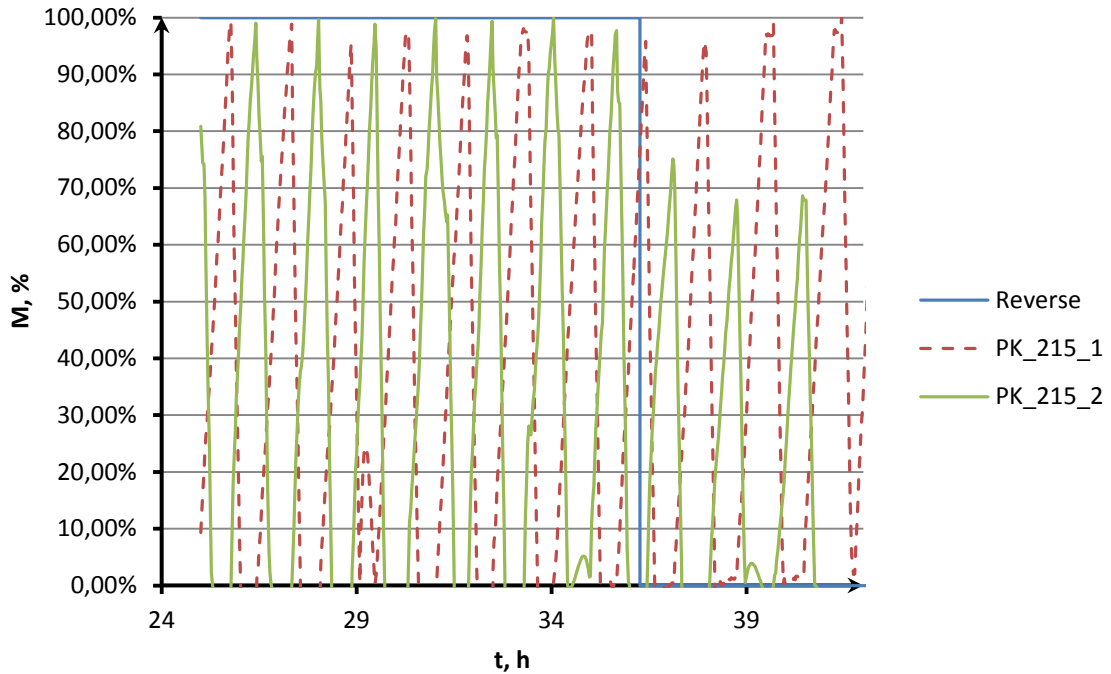

Figure 2 – Amount of solid-phase components in chamber feeders CTM

Figure 2 shows that the work of the horizontal part of the device is acceptable for both directions rotation of the mixer. This is proven by continuous filling of chamber feeders and by the independence of the mixer rotation direction.

This feature allows us to make a conclusion that rotation of the mixer tends to align with the distribution profile of solid-phase components inside the machine. Based on structural features of the device (Figure 3), it has been assumed that an ideal mixing occurs at the interval Δl in figure 3, which corresponds to 150 mm. This is due to different orientation of the mixer blades on the interval.

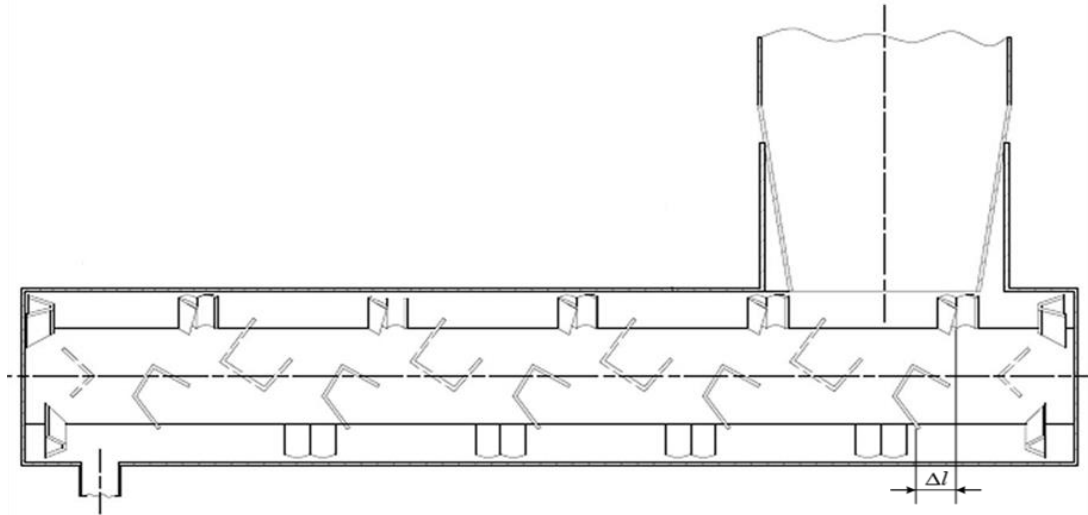

Figure 3 - The horizontal part of the CTM

Accepted assumption allows us to make a system of two equations based on the model of perfect mixing describing stirring at the interval Δl figure 3 [2].

$$\begin{cases} \frac{dM_1^k}{dt} = (M_2^k - M_1^k) / 2 \cdot T_{mix}, \\ \frac{dM_2^k}{dt} = (M_1^k - M_2^k) / 2 \cdot T_{mix}. \end{cases} \quad (1)$$

$k = UO_2, UO_3, UO_2F_2, UF_4$;

M_1^k, M_2^k - weight k -th component in the i -th cell, kg;

T_{mix} - inertia of mixer.

The time constant was obtained experimentally and it is described by mathematic equation:

$$(2) \quad T_{mix} = \frac{60}{3 * N_{mix}}$$

Equation (2) was obtained by adjusting the coefficient of the multiplier $60/N_{mix}$ of time corresponding to one turn of the mixer that achieves ideal mixing of two adjacent cells.

The resulting system of equations describing the distribution of the solid-phase components in horizontal part of CTM is represented by the expression:

$$\begin{cases} \frac{dM_1^k}{dt} = (M_2^k - M_1^k) / 2 \cdot T_{mix}. \\ \dots \\ \frac{dM_i^k}{dt} = (M_{i-1}^k + M_{i+1}^k - 2 \cdot M_i^k) / 2 \cdot T_{mix}, \\ \dots \\ \frac{dM_{39}^k}{dt} = (M_{38}^k - M_{39}^k) / 2 \cdot T_{mix}. \end{cases}$$

$$k = UO_2, UO_3, UO_2 F_2, UF_4;$$

To create a mathematical description of the horizontal part, 38 cells with the width of 75 mm, and one cell, the width of which is equal to 70 mm have been described. The principle of separating horizontal part of the CTM is described in Figure 4.

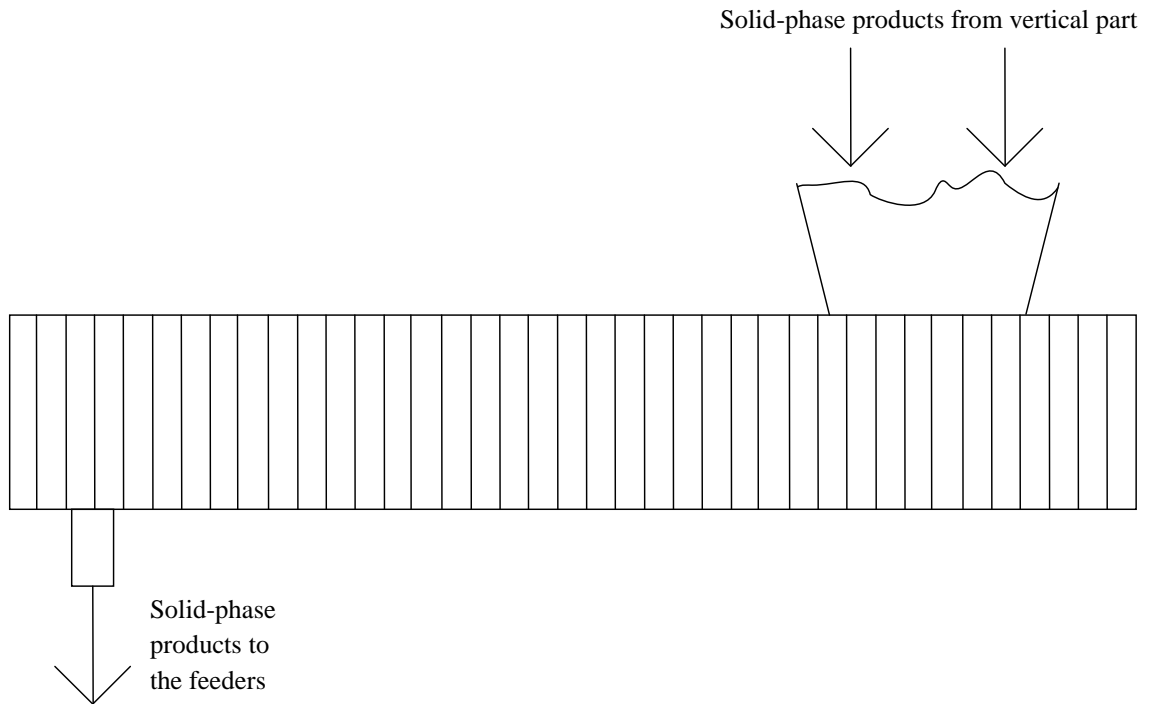

Figure 4 - The principle of horizontal partitioning of CTM into elementary cells

Results

All of researches were carried out in the package Matlab. After making a computer model in Matlab and our researches, we compared the model graphs and derived from actual production trends. In this case, we took into account only the areas with devastation of chamber feeders (Figure 5). After that we calculated standard deviation [3]. It was near 6,5 %.

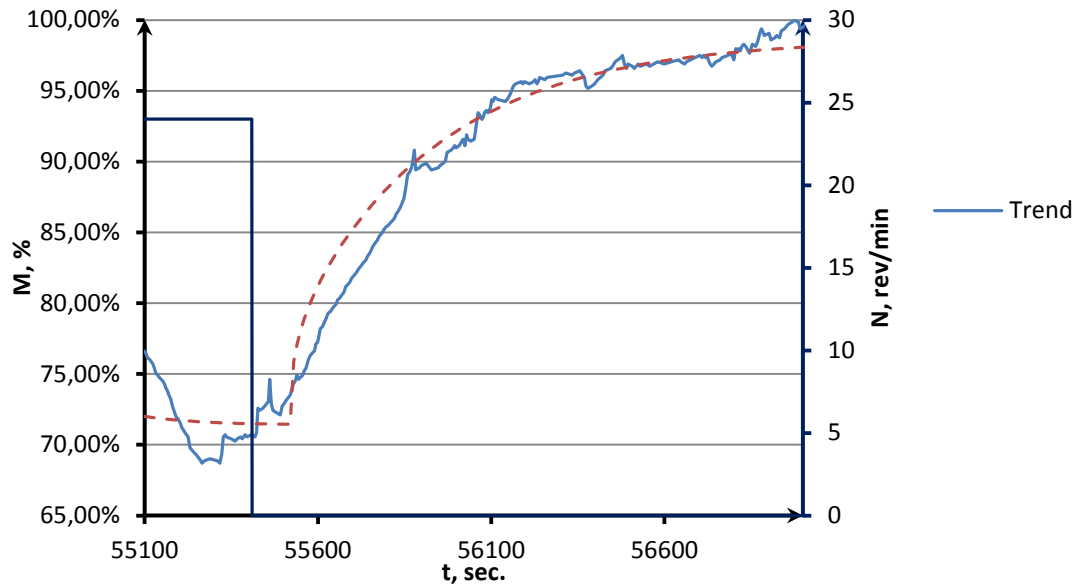

Figure 5 Change in reading devices load feeders chamber when emptying the horizontal part of the CTM
With the help of the mathematical model developed ACP calculated intermediate distribution [4] along the length of the device at nominal operation of the existing oxide production line of uranium hexafluoride.

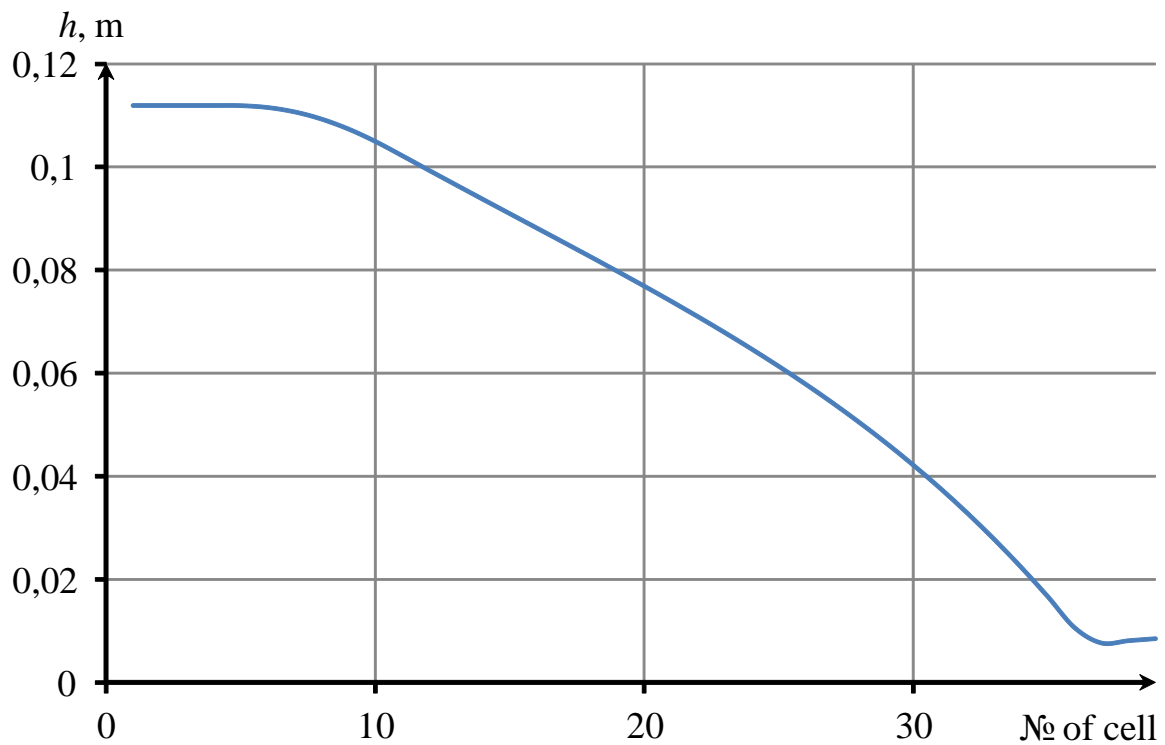

Figure 6 - Distribution of components in mixer's cells

From the figure 6 we can see distribution of components in mixer at the nominal operating level of production.

Conclusion

The result of this work is a dynamic mathematical model of the horizontal part of the CTM, the adequacy of which was proved by comparing the calculated data with the trends. The developed model will be used in the synthesis of solid-phase matching algorithm of loading components in machines of PHU.

References

1. Baydali, S. A. Automation and management of technological processes. Dissertation work for the degree of candidate of technical sciences
2. Slinko, M. G., Beeskov, V. S., Skomorokhov, V. B., etc. Methods for modeling of catalytic processes on analog and digital computers. Novosibirsk. Science, 1972.
3. Lisev, V. P. Probability theory and mathematical statistics. Moscow, 2006.
4. Glushko, M. M. Russian – English dictionary math minimum, 1988.

PLASMA-CHEMICAL DISSOCIATION OF HYDROGEN SULFIDE

D.S. Filatov, S.A.Rakhmanov

Scientific Supervisor: PhD, Associate professor Y.B. Shvaley

Language advisor: Senior teacher N.N. Zyablova

Tomsk Polytechnic University, Russia, Tomsk, Lenin str., 30, 634050

E-mail: fds2517@mail.ru

Abstract

This article summarizes the existing achievements for hydrogen and elemental sulfur production by plasma-chemical dissociation of hydrogen sulfide. Because of the fact that oil and natural gas will soon end, development of environmentally clean hydrogen-based energetic is especially actual. Also possibility of obtaining the elementally pure sulfur, which is used in the wide range of industries from construction to agriculture, looks attractive. During the industrial test a reactor was designed and the parameters, that allow to proceed the hydrogen sulfide dissociation with minimal energy consumption and acceptable yields of the final products, were found.

Keywords: *alternative energy, plasma, dissociation of hydrogen sulfide, hydrogen production, plasma torch.*

Introduction

It is well known that reserves of natural hydrocarbon fuel will run out in the coming decades. Moreover, already there is an acute problem of the environmental effects of using fossil fuel. In this way introduction of hydrogen as energy carrier becomes very actual. Development of hydrogen energetic and reduction of natural fuels consumption allow alleviating the energy problem in the near future, and afterward when the industrial using of thermonuclear fusion will be disbursed completely solving it. A major challenge for wide industrial use of hydrogen energy in the moment is the lack of highly efficient methods of producing hydrogen. A new approach to generating hydrogen from the hydrocarbon feedstock may be based on the phenomenon of catalytic activity of non-equilibrium plasma in chemical reactions. The aim of this work is to highlight the current developments on the process of energy efficient hydrogen sulphide decomposition using plasma to yield hydrogen gas and solid sulfur. Review of existing methods of hydrogen sulphide dissociation

1.1 The chemistry of the hydrogen sulfide dissociation

First of all it is necessary to consider the process from a chemical point of view. The dissociation of hydrogen sulfide in the thermal plasma consists of the following steps [2]:

- 1) $\text{H}_2\text{S} \leftrightarrow \text{H}^\bullet + \text{HS}^\bullet - 4 \text{ eV};$
- 2) $\text{H}^\bullet + \text{H}_2\text{S} \leftrightarrow \text{H}_2 + \text{HS}^\bullet + 0,55 \text{ eV};$
- 3) $\text{HS}^\bullet + \text{HS}^\bullet \leftrightarrow \text{H}_2\text{S} + \text{S}^\bullet + 0,39 \text{ eV};$
- 4) $\text{S}^\bullet + \text{H}_2\text{S} \leftrightarrow \text{H}_2 + \text{S}_2 + 1,83 \text{ eV};$
- 5) $\text{S}^\bullet + \text{HS}^\bullet \leftrightarrow \text{H}^\bullet + \text{S}_2 - 0,45 \text{ eV};$
- 6) $\text{H}^\bullet + \text{HS}^\bullet \leftrightarrow \text{H}_2 + \text{S}^\bullet + 1,12 \text{ eV};$

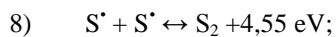
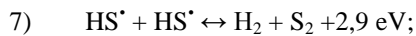

The mechanism of these reactions is radical.

The dependence of the specific energy consumption A for hydrogen production on specific energy input E (heating temperature) is found on the basis of thermodynamic calculations. This relationship is shown in Figure 1:

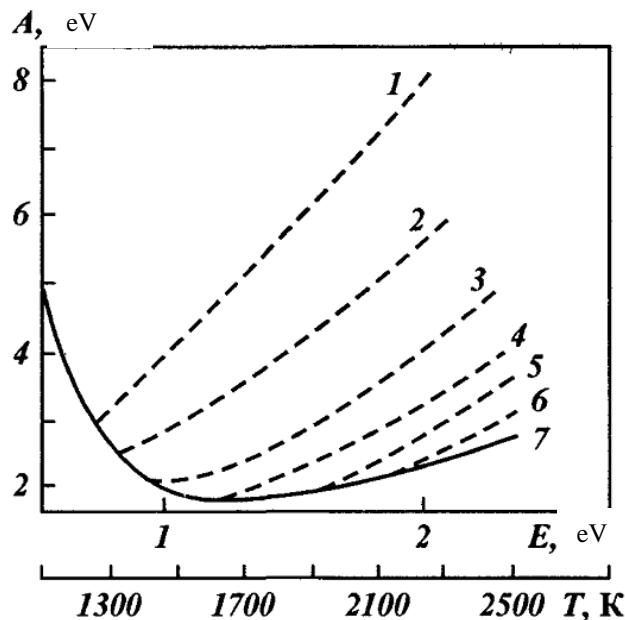

1 - $\omega = 10^1 \text{ K/s}$, 2 - 10^2 K/s , 3 - 10^3 K/s , 4 - 10^4 K/s , 5 - 10^5 K/s , 6 - 10^6 K/s , 7 - 10^7 K/s

Figure 1 - The dependence of the specific energy consumption for hydrogen production on specific energy input (heating temperature) at cooling rates [2]

From the graph in figure 1 we see that at cooling rates of 10^7 K/s ideal hardening is observed in the whole range of temperatures actually, i.e. radicals produced during heating recombine into products increasing the hydrogen yield. Moreover, at temperatures corresponding to the minimum energy value ($A = 1.8 \text{ eV}$, $T = 1700 \text{ K}$), a relatively low cooling speed $\omega = 10^4 - 10^5 \text{ K/s}$ is sufficient to complete stabilization of the dissociation products[2].

2.2 Technological scheme of plasma-chemical hydrogen sulfide dissociation. Pilot production testing of plasma-chemical hydrogen sulfide gases dissociation was implemented in technological development workshop on the court of the Orenburg gas processing plant. All-Russian Scientific Research Institute of High Frequency Current created two plasma-chemical blocks [3]:

- power of 500 kW and frequency of 915 MHz;
- power of 600 kW and frequency of 440 kHz.

Block diagram of the experimental-industrial stand with plasma-chemical unit (power of 600 kW and frequency of 440 kHz) is shown in Figure 2.

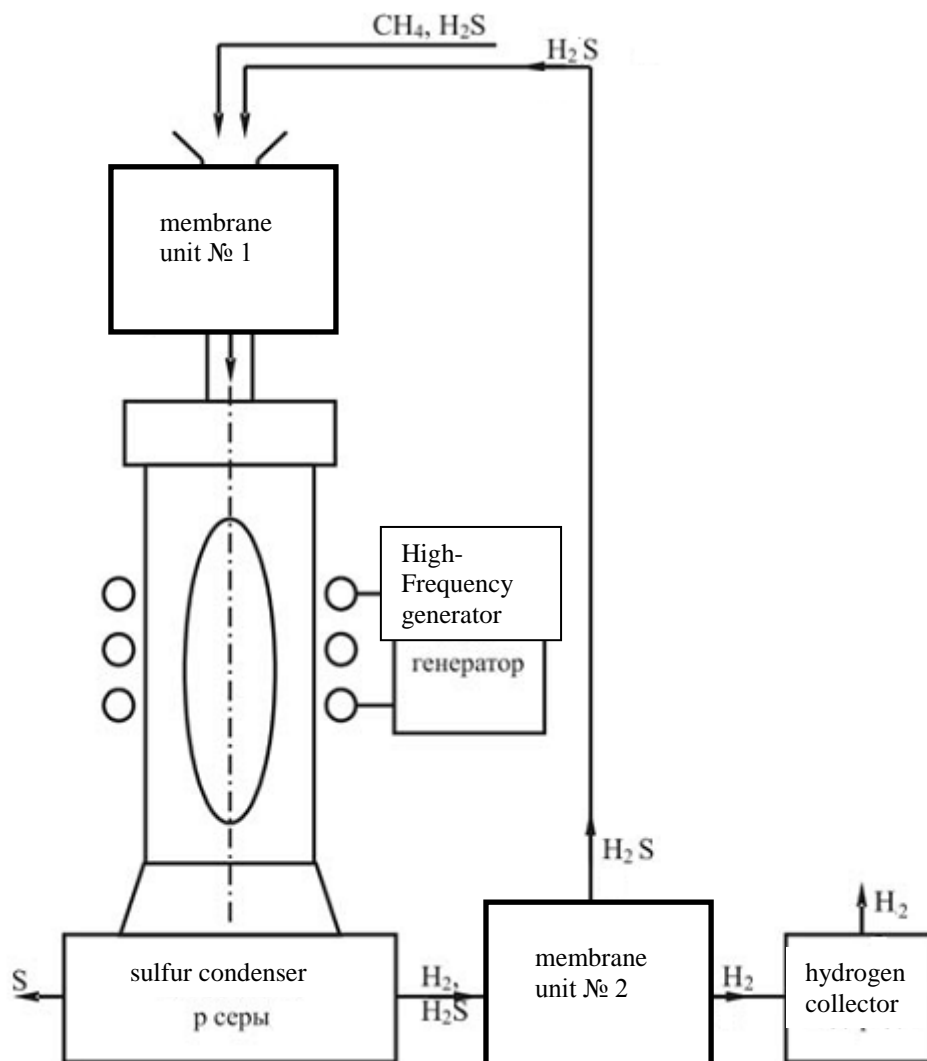

Figure 2 - Block diagram of high-frequency stand for separation and decomposition of hydrogen sulfide [3]
 The stand consists of a high-frequency generator with oscillation capacity of 600 kW and the current frequency of 440 kHz, plasma torch unit including a plasma torch, an inductor and the capacitor battery, input (№1) and output(№2) membrane units, sulfur condenser and hydrogen collector. Undecomposed sulfide is directed to recycling. Plasma-forming gas is a mixture of H_2S and CH_4 . The discharge initiation is carried under argon atmosphere. In order to reduce power losses structure of a quartz discharge chamber and vortex stabilization of discharge (shown in Figure 4c) is used in the plasma torch. The outer diameter of the pipe is 180 mm, length is 750 mm. Plasma-forming gases are supplied through 32 tangential holes that are made in gas-forming head of the plasma torch [3]. When designing high frequency (HF) power plants with induction plasma important task is minimizing the ohmic losses in the inductor, which can be 10 percent or more of the output HF power unit (that is unacceptable in terms of energy). All-Russian Scientific Research Institute of High Frequency Current designed and manufactured inductor (shown in Figure 7), which litzcurrent source was applied in.

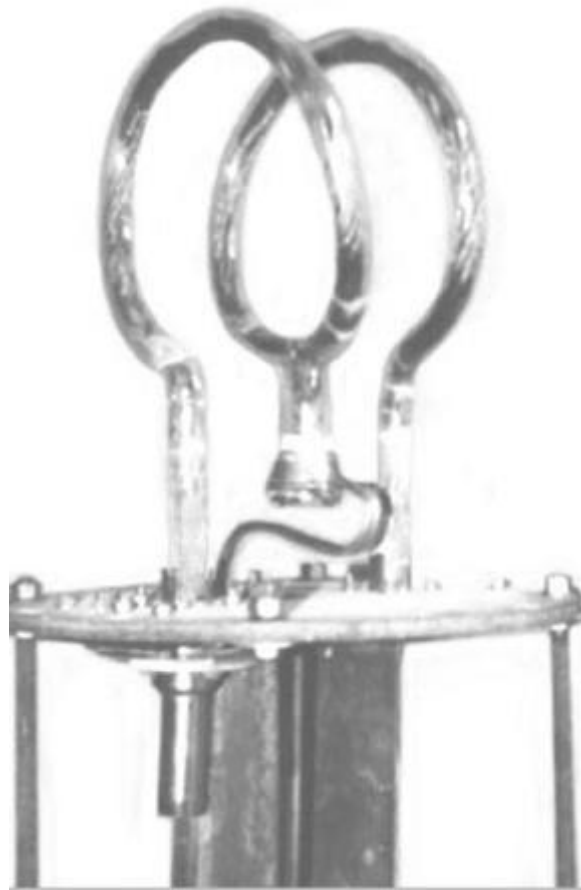

Figure 3 - General view of litz inductor [3]

In this case single conductor (tube) of inductor is replaced by a multi-conductor system consisting of a large number of parallel thin wires intertwined to ensure flow of current across the entire cross-section of each conductor. Calculations and tests of inductor have shown that the ohmic losses are reduced to 7 times or more as compared to an inductor made of a copper pipe [3]. Difficulties encountered when creating litz inductor is to choose a dielectric material for water-cooled cover, which current carrying is lived in. Shaped quartz was used in the made inductor. On plasma-chemical unit of Orenburg stand the interaction of individual basic units and stand together were worked, was confirmed low level of energy consumption for plasma-chemical conversion process of hydrogen sulfide gases as using UHF and HF plasma equipment at 1 kW·h for a 1 m³ of hydrogen and 1.4 kg sulfur [3].

Conclusion

Currently, hydrogen sulfide is considered useless component of crude oil which is not used. However, the depletion of oil and the switching to hydrogen fuel is a matter of time only. This method of hydrogen production is energy efficient and suitable for engraining, also a sulfur by-product may be used in civil engineering as the additive to concrete. The method needs to be working out to search for optimal parameters of plasma and hydrogen sulfide flow, but now it is suitable for use.

REFERENCES

1. Verzhichinskaya S. V. Khimiya i tekhnologiya nefi i gaza. – M.: FORUM, 2009. – 400 s.
2. Murin V. I. Tekhnologiya pererabotki prirodnogo gaza i kondensata. – M.: ООО «Nedra-Biznestsentr», 2002. – CH. 1. – 517 s.
3. Vysokoeffektivnyye plazmennyye tekhnologii dlya neftyanoy i gazovoy promyshlennosti / V.N. Ivanov, B.M. Nikitin // Ekspozitsiya nefi' gaz. – 2010. - №7. – S. 13-17.
4. Neorganika (Tom 2) / L. Koldits, G. Blyumental', Engel's Z.
5. Khimicheskiy demonstratsionnyy eksperiment - M.: Vysshaya shkola, 1969. - 248 s / Ivanova MA, Kokonova MA
6. Vvedeniye v vodorodnyuyu energetiku / E. E. Shpil'rayn, S. P. Malysenko, G. G. Kuleshov
7. Okislitel'nyye protsessy otchistki prirodnikh sernykh gazov i uglevodorodnykh kondensatov / G. A. Agayev V.I. Nasteka, Z. D. Seidov.

DEVELOPMENT OF THORIUM-CONTAINING NUCLEAR FUEL CYCLE

I.M. Gubaydulin, S.V. Bedenko

Scientific Supervisor: Dr., Prof. Ig.V. Shamanin

Language Advisor: Senior teacher N.G. Novikova

Tomsk Polytechnic University, 30, Lenin Avenue, Tomsk, 634050, Russia

E-mail: commander_tom@mail.ru

Annotation

The results providing advantages of thorium-232 as a reproducing nuclide in comparison with uranium-238 as a part of nuclear fuel of new generation reactors are presented. The explanation of the effects which were found earlier in numerical simulation of parameters of open thorium - plutonium nuclear fuel cycle is offered. Scientific and technical solutions allow considering the possibility of including thorium-232 in the fuel of nuclear reactors, which are based on existing design solutions, and beginning the design of new generation materials: a new generation of fuel rods and fuel assemblies, where the isotope uranium-238 will be completely replaced with thorium-232.

Keywords: Materials of new generation, resonance absorption, Doppler-effect (Doppler), multiply lattice.

Research field: Nuclear physics.

The state of research

Recently it has become obvious that nuclear power is one of the priority parts of global energy. Today, nuclear power is primarily based on one of radioactive elements – uranium. However, the strategy of nuclear power development of Russia and other countries provides putting in operation a nuclear fuel cycle, which is based on plutonium and thorium. The main importance of these elements is their capability to resupply secondary nuclear fissile materials [1, 4 – 6].

The question of involving thorium in the nuclear fuel cycle is connected with sufficiently developed concept of thorium-uranium nuclear fuel cycle (NFC). Thorium is considered as raw nuclide, the use of which provides breeding of fissile nuclide ^{233}U . Thus there are two major problems of the concept realization. The first is accumulation in irradiated thorium nuclei of ^{232}U , the decay of which eventually leads to the accumulation of hard γ - emitters and the formation of a complex radiation situation during storage and reprocessing of spent thorium-containing nuclear fuel. The second problem is increase of massic activity during extraction of minerals and thorium storing, which also leads to the accumulation of high concentration of γ - emitters, which are products of nuclear decay of ^{228}Th .

It should be noted, that in case of using thorium-containing nuclear fuel in a fuel cycle of the new generation it is essential to solve the tasks, which were earlier successfully solved in connection with regenerated uranium fuel, in particular, problems of radiation safety connected with accumulation of ^{228}Th , which formed during disintegration of ^{232}Th (thorium-containing nuclear fuel) and ^{232}U (regenerated fuel) [4 – 6].

Massic activity of natural thorium is 0,109 Ci/t, natural uranium - 5,135 Ci/t (activity of 4 g of natural thorium is equivalent to activity of 1 mg of ^{226}Ra). Although concentration of ^{228}Th is less than $1.5 \cdot 10^{-}$

8% (with the half-life of 1.91 years) in natural thorium, occurrence and decay of ^{228}Th determine the radiological hazard of pure natural thorium. ^{228}Th is formed by β -decay of ^{228}Ac , which is formed by β -decay of ^{228}Ra (with the half-life of 5.75 years). ^{228}Ra is a product of α -decay of raw ^{232}Th which is of great interest for us [4 – 6].

The raw isotope ^{232}Th is the source of fissile isotope - ^{233}U and does not cause any radiological hazard. But ^{232}Th is α -active with the half-life of 13.9 billion years. The age of the Earth is about 4.5 billion years as far as disintegration rate of uranium and thorium are concerned. Half-life of ^{238}U which has an important role in uranium-plutonium nuclear fuel cycle is 4.47 billion years and this value is equal to the age of the Earth, but half-life of ^{232}Th is significantly greater than the age of the Earth.

The structure of the resonance region of neutron absorption by ^{232}Th and ^{238}U nuclei

A deeper study of available experimental information about the resonance absorption of neutrons by nuclei of ^{232}Th and ^{238}U make it possible to state the existence of another feature except where noted above. Two powerful resonances with amplitudes about 13,000 and 17,000 b were found during interaction of neutrons with nuclei ^{238}U in energy range from 4 to 24 eV were found. The interaction of neutrons with nuclei of ^{232}Th in the same energy region also has available resonance (about 300 b), but its amplitude is negligible compared to resonances in case of ^{238}U . Figure 1 shows the cross sections of neutron energy recovered from the experimental data [2] as it was mentioned above.

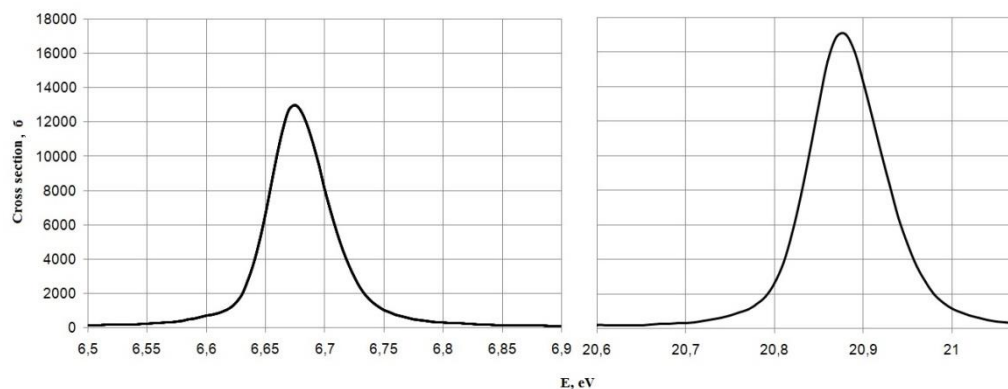

Fig. 1. Neutron absorption cross section of ^{238}U nuclei in the energy range of 6.5 ... 21.2 eV

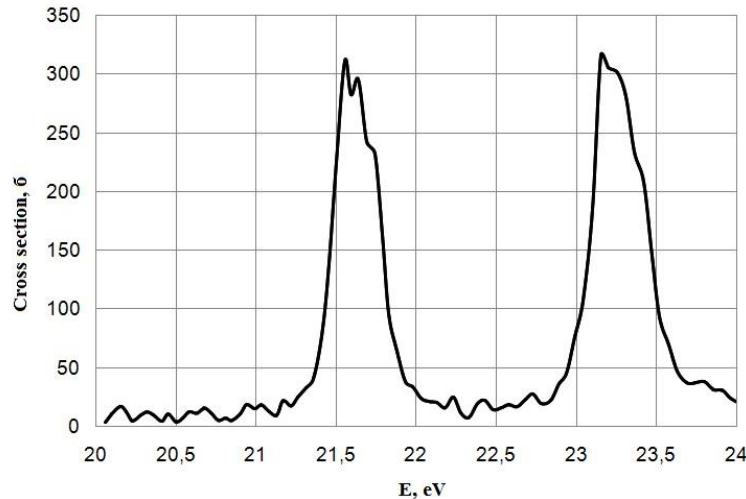

Fig. 1. Neutron absorption cross section of ^{232}Th nuclei in the energy range of 20 ... 24 eV

Resonances depending on neutron absorption cross section for both ^{238}U and ^{232}Th are in the energy range with the upper limit of 4.65 keV [3]. It begins from group “13” (in 26th – or 28th - group presentation). The least energy value which equals the strong resonance of 238U with the amplitude of 13 000 b is about 6.7 eV (fig.1). This value fits into the interval corresponding to group “21”: $4.65 \div 10$ eV.

In case when the absorbing nuclei are considered motionless, microscopic cross-section absorption at single resonance is defined by the formula of Breit-Vigner [4]:

$$\sigma(E) = \sigma_r \left(\frac{E_r}{E} \right)^{1/2} \frac{\Gamma^2 / 4}{(E - E_r)^2 + \Gamma^2 / 4}, \quad (1)$$

where E - neutron energy, σ_r - amplitude of resonance, E_r - region of resonance, Γ - resonance width.

Heat motion of resonant absorber nuclei causes change of the absorption line change. This change is called Doppler-effect and its meaning is in the following. The resonance line becomes wider with the growth, the resonance amplitude decreases; the square of the absorption line does not change. The width of “dangerous energy zone”, in which the neutron can be captured because of Doppler-effect, increases. In this case the possibility of the neutron to skip the zone for a neutron, which loses energy in dissipation processes on moderator nuclei and moves by the energy scale to the heat group, decreases.

Doppler width is defined by:

$$\Delta = 2 \left(\frac{m E_r k T}{M} \right)^{1/2}, \quad (2)$$

where m - mass of neutron, M - mass of nucleus of resonant absorber, k - Boltzmann’s constant, T - temperature.

Probability for a neutron to be captured or scattered on moderator nucleus in the first resonant

interaction is described by this correlation $(\sigma_{C_r} \cdot C_r) / (\sigma_{C_m} \cdot C_m)$, if we exclude all other processes, where σ_c - microscopic cross section of absorption, σ_s - microscopic cross section of scattering, C - concentration of nuclei, index r - refers to the resonance absorber, index m - relates to the moderator. The parameter is mentioned in Ya.B. Zeldovich and Y.B. Haritona researches [5] and in equation (1), at low energies it is equal to $E^{-\frac{1}{2}}$. It allows us considering the corresponding cross section, along with other non-resonance ones. Another part of equation (1) is a function, which determines only absorption resonances.

Solving equations for the sum probability of the neutron to be decelerated without being captured in the dangerous resonant zone, the [5] obtained that the probability to escape such capture φ is defined by the relation:

$$-\ln \varphi = \left(\frac{\pi}{2}\right) \sum_i \left(\frac{\Gamma_i}{E_{r_i}}\right) \left[\eta \sigma_s (1 + \eta \sigma_s / \sigma_{r_i}) / \sigma_{r_i} \right]^{\frac{1}{2}}, \quad (3)$$

where summation is over all the resonance, i - number of resonance, $\eta = C_m / C_r$.

Let us designate the average arithmetic of absorption micro cross section in single resonances within the limits of the corresponding energy group as $\overline{\sigma_r}$. For theoretical analysis it is convenient to suppose that in each energy group there is one “average resonance”, amplitude of resonance absorption cross-section being $\overline{\sigma_r}$. The position of this resonance on the scale of neutrons energy $\overline{E_r}$ corresponds to the middle of the group energy interval for this group. The width of such “averaged” resonance for the group is $\overline{\Gamma}$. In relation (2) the value 2ω is the multiplier defining the Doppler width of the “averaged” resonance $\overline{\Delta} = 2\omega\sqrt{T}$. It characterizes the sensitivity of the resonance to temperature changes, as

$$\frac{d\overline{\Delta}}{dT} = \omega / \sqrt{T}, \quad (4)$$

The bigger the value of ω , the bigger the width of the “dangerous energy zone” becomes at the same temperature growth of the same resonant absorber.

The analysis of the resonance area structure in a multi group approximation shows that ^{232}Th resonances (in comparison with ^{238}U) are absent in two epithermal groups 21 and 20, that is in energy intervals of 4.65 ÷ 10 and 10 ÷ 21.5 eV, correspondingly. ^{238}U has 8 powerful resonances located in group from 21 to 17. It provides significant values of absorption cross-section amplitudes in “averaged” resonances in these groups. ^{232}Th is characterized by the presence of large amount of resonant lines with relatively small amplitude, they are located in the energy intervals of 20 ÷ 4050 eV. It is necessary to note that Doppler-effect on ^{232}Th nuclei is stronger. It is proven by the comparison of the values ω for various energy groups beginning from 19th. The Doppler width of ^{232}Th nuclei is 1.3% bigger than of ^{238}U nuclei in the temperature range of 293 ÷ 1093 K. In total it provides Doppler-effect superiority of 1.6% on a separate ^{232}Th nucleus in

comparison with ^{238}U .

The changes of the values of nuclear reaction cross section by 1...2% for a specialist in the field of atomic nucleus and elementary particles physics is of no interest. As a rule such change is smaller than measure of inaccuracy of the cross section determination in experiments. But if we speak about physics of nuclear reactors, such change becomes more significant. It is enough to remember that the total nuclear reactor reactivity is 10-15%, but an effective part of lagging neutrons in such a reactor does not increase the value of 0.7%. Nuclear reactor can be controlled when the effective multiplication factor in it increases one on value less that effective lagging neutrons part. When the reactor is operating under usual conditions, the rules of nuclear safety allow the deflection of effective multiplication factor of tenth of % approach the side bigger than one. Thus the presence of resonance absorber in the active reactor zone which at the same time is the source nuclide with advantages of Doppler-effect impact of 1-2% makes the nuclear reactor more safe.

As it has been already noted, the Doppler-effect causes the resonance amplitude decrease, as far as the 16th energy group is concerned. In table 1 the values of the function Ψ for ^{238}U и ^{232}Th are shown. It characterizes the ratio of resonance amplitude at temperature T to the amplitude at temperature 273.3 K. The value Ψ is determined in terms of the formalism explained in [4].

Table 1. Decrease of resonances amplitude in the 16th energy group

T, K	293	493	693	893	1093
^{232}Th	0.982835	0.972027	0.961839	0.952196	0.943035
^{238}U	0.952022	0.925332	0.901975	0.88118	0.862424

Thus we can state that the increase of temperature causes bigger growth of the “dangerous energy zone” width at decrease of resonance amplitude on ^{232}Th nuclei. The square under the resonance line remains the same, but the shape of the line changes. This shape is described by the formula [4]:

$$\Psi(x, \zeta) = \frac{\zeta}{2\sqrt{\pi}} \int_{-\infty}^{+\infty} \frac{\exp\left[-\frac{1}{4}\zeta^2(x-y)^2\right]}{1+y^2} dy, \quad (5)$$

where $x = 2(E' - E_r) / \Gamma$; $\zeta = \Gamma / \Delta$; $E' = m'v^2 / 2$; $m' = mM / (m + M)$ - rotating mass of the neutron; $v = (2E / m)^{1/2}$ - velocity of the neutron.

The Doppler-effect on ^{232}Th nuclei results in bigger growth of neutrons resonance absorption in comparison with ^{238}U , but the primary advantage of ^{232}Th in these energy groups is connected with the absence of resonances in groups 20 and 21. It should be emphasized once more that ^{238}U in these 2 groups has two powerful resonances with the amplitudes of 17 000 and 13 000 b, correspondingly.

Conclusion

Analysis of scientific data allows to make an important conclusion that ^{232}Th has undeniable advantages. These advantages were caused by ^{232}Th as a resonance absorber which provides high levels of negative

temperature coefficient of reactivity and allows reconsidering well-known and conventional thinking in the field of designing of nuclear fuel assemblies of nuclear reactors.

Scientific and technical solutions obtained in this work allow considering the possibility of using ^{232}Th in reactors nuclear fuel, which are based on existing design solutions, and also beginning to design a new generation materials of fuel assemblies, where the raw isotope ^{238}U is fully substituted by ^{232}Th .

References:

1. N.N. Ponomarev-Stepnoi, G.L. Lunin, A.G. Morozov and other. Light water thorium reactor VVER-T // Atomic Energy. - 1998. - T.85, № 4. - pp. 263-277.
2. Group constants for reactor calculations and protection calculation: Reference/ L.P. Abagyan, N.O. Bazazyants, A.M. Tsibulya, edited by M.N. Nikolaev - Oxford: Clarendon Press, 1981, 231 p.
3. I.V. Shamanin, A.A. Ukhov, H.J. Rutten, K. Haas, W. Sherer. The Use of (Th, U, Pu) O_2 Fuel in a Water Water Energy Reactor(WWER-1000): Physics and Fuel Cycle Simulation by means of the V.S.O.P.(97) Computer Code, FZJ-ISR-IB-1/99. – Forschungszentrum, Julich, 1999. – 40 p.
4. I.V. Shamanin, A.A. Ukhov, H.J. Rutten, K. Haas, W. Sherer. Results of simulation parameters of fuel cycle for light water power reactor // News of high school. Nuclear power. – 2000. - № 4. - pp. 53-64.
5. I.V. Shamanin, S.V. Bedenko, I.M. Gubaydulin, Optimum Ratio of Coverings Thickness to the Diameter of the Fuel Core of the Dispersive Nuclear Fuel // Advanced Materials Research. - 2014 - Vol. 880. - pp. 219-228.
6. Y.B. Chertkov, A.G. Naimushin, S.A. Mongush, Alternative placement of burnable poisons the reactor VVER-1000 // News of high school. Physics. – 2014. – T. 57- № 2/2. - pp. 57-62.
7. A.V. Golovatsky, V.N. Nesterov, I.V. Shamanin, The optimum operating temperature for graphite to supply the designed burnup of nuclear fuel in the reactor GT-MGR // News of TPU. – 2011 – T. 319 - №. 2 – pp. 71-76.

ENERGY OF THE FUTURE: NUCLEAR VS OTHER SOURCES

D.O. Kondratjev, M.P. Gritsevich

Scientific Supervisor: Senior teacher A.V. Godovykh

Linguistic Advisor: Senior teacher N.V. Daneykina

Tomsk Polytechnic University, Russia, Tomsk, Lenin str., 30, 634050

E-mail: thedk@inbox.ru

Annotation

Everybody knows that we live in a time of energy crisis. The World's Fossil Fuels are a finite resource that will be consumed within 500 years at present and projected future rates of consumption. In addition these are often accompanied by substantial pollutants and of course their major waste by-product, carbon-dioxide gas, is the major Greenhouse emission of concern [1, 2]. Of course every energy source has its advantages and disadvantages. The goal of the work was a comparing nuclear power with other energy sources and the proof that this type of energy is most beneficial to humanity. Objective was detection superiority of nuclear power over other types of energy sources on the following points:

- *Cost;*
- *Efficiency;*
- *Safety;*
- *Environmental.*

Key words: nuclear energy, power plant, hydrocarbon, fossil fuel, renewable sources, biomass.

In the last years, people have searched for alternatives, pouring billions of dollars into windmills, solar panels, and biofuels. We've designed fantastically efficient lightbulbs, air conditioners, and refrigerators. But mainly, each year we hack 400 million more tons of coal out of Earth's crust than we did a quarter century before, light it on fire, and shoot the proceeds into the atmosphere.

The consequences aren't pretty. Burning coal and other fossil fuels is driving climate change, which is blamed for everything from western forest fires and Florida hurricanes to melting polar ice sheets and flooded Himalayan hamlets. On top of that, coal-burning electric power plants have fouled the air with enough heavy metals and other noxious pollutants to cause 15,000 premature deaths annually in the US alone, according to a Harvard School of Public Health study. Scientists have proved that a coal-fired plant releases 100 times more radioactive material than an equivalent nuclear reactor. (And, by the way, more than 5,200 Chinese coal miners perished in accidents last year.)

Burning hydrocarbons is a luxury that a planet with 6 billion energy-hungry souls can't afford. There's only one sane, practical alternative: nuclear power [3].

We now know that the risks of splitting atoms pale beside the dreadful toll exacted by fossil fuels. Radiation containment, waste disposal, and nuclear weapons proliferation are manageable problems in a way that global warming is not. Unlike the usual green alternatives - water, wind, solar, and biomass - nuclear energy is here, now, in industrial quantities. Sure, nuclear plants are expensive to build - upward of \$2 billion apiece - but they start to look cheap when you factor in the true cost to people and the planet of burning fossil fuels.

And nuclear is our best hope for cleanly and efficiently generating hydrogen, which would end our other ugly hydrocarbon addiction - dependence on gasoline and diesel for transport [3, 4].

And the worst - by far - is yet to come. An MIT study forecasts that worldwide energy demand could triple by 2050. China could build a Three Gorges Dam every year forever and still not meet its growing demand for electricity. Even the carbon reductions required by the Kyoto Protocol - which pointedly exempts developing countries like China - will be a drop in the atmospheric sewer [3].

Hydrocarbon energy is obvious disadvantages. How can we solve this problem? There are two choices. The first is renewable energy sources such as wind, water, solar, or biomass. All of them are attractive but powerless. They aren't able to produce enough power [5]. For example, One Nuclear Power Plant produces 1000 megawatts per hour. You would need 60,000 acres and 2400 to 2800 wind turbines to equal 1,000 megawatts. Also you need 5,000 acres of solarpanels to equal 1,000 megawatts of electricity. Those solar panels only work at peak power levels during the sunny times, so, on average, they only put out about 25% of their rated capacity. That means you really need 20,000 acres of solar panels to generate 1,000 megawatts of electricity per hour, on average. 20,000 acres is 31.25 square miles [6].

The decline would be even worse without hydropower, which accounts for 92 percent of the world's renewable electricity. But this type of energy is under attack from environmentalists trying to protect wild fish populations.

Solar power doesn't look much better. Its number-one problem is cost: While the price of photovoltaic cells has been slowly dropping, solar-generated electricity is still four times more expensive than nuclear (and more than five times the cost of coal). Maybe someday we'll all live in houses with photovoltaic roof tiles, but in the real world, a run-of-the-mill 1,000-megawatt photovoltaic plant will require about 60 square miles of panes alone. In other words, the largest industrial structure ever built.

Wind is more promising, which is one reason it's the lone renewable attracting serious interest from big-time equipment manufacturers like General Electric. But even though price and performance are expected to improve, wind, like solar, is inherently fickle, hard to capture, and widely dispersed. And wind turbines take up a lot of space.

What about biomass? Ethanol is clean, but growing the amount of cellulose required to shift US electricity production to biomass would require farming - no wilting organics, please - an area the size of 10 Iowas [3]. By contrast, nuclear power is thriving around the world despite decades of obituaries. Belgium derives 58 percent of its electricity from nukes, Sweden 45 percent, South Korea 40, Switzerland 37 percent, Japan 31 percent, Spain 27 percent, and the UK 23 percent, in north-west Russia reaches 42% and about 18% countrywide, in Turkey plans to build three plants over the next several years. South Korea has eight more reactors coming, Japan 13, China at least 20. France, where nukes generate more than three-quarters of the country's electricity, is privatizing a third of its state-owned nuclear energy group [3].

What about price of electricity of different sources? Current operating costs are the lowest ever - 1.82 cents per kilowatt-hour versus 2.13 cents for coal-fired plants and 3.69 cents for natural gas. The ultimate vindication of nuclear economics is playing out in the stock market: Over the past five years, the stocks of

leading nuclear generating companies such as Exelon and Entergy have more than doubled [3].

Of all the energy sources discussed here, Nuclear Fission Power is the lowest-cost form of non-greenhouse energy production. The second-generation reactors currently operating at World's best-practice level consistently produce low-cost electricity with no greenhouse gas emissions at high reliability. The French decision to go all - Nuclear has paid-off handsomely and Sweden has the almost the lowest priced electricity in Europe. Furthermore, Denmark's Greenhouse Gas emissions per capita are substantially greater than both France and Sweden since the Danes use coal power for the majority of their electricity needs even with their commitment to Wind Power.

In the longer term advanced reactors, fusion-fission hybrids and accelerator driven systems that efficiently use the World's abundant Thorium and Uranium reserves have the capability to power a planet-wide advanced civilization essentially indefinitely. They also have the capability to generate energy from and dispose of the long-lived transuranic waste. However this technology will always require strict safeguards and independent oversight [1].

References

1. Comparison of Energy Sources. Retrieved March 21, 2013 from <http://nuclearinfo.net/Nuclearpower/WebHomeComparisonOfEnergySources>
2. Marco Pelucchi (2003, November 3). European electricity prices in 2002 [Electronic version], 5.
3. Peter Schwartz and Spencer Reiss (2004, February 13). Nuclear Now! Retrieved March 23, 2013 from <http://www.wired.com/wired/archive/13.02/nuclear.html>
4. Amanda Griscom Little (2003, February). *The environmental movement.* Retrieved March 23, 2013 from http://www.wired.com/wired/archive/13.02/nuclear.html?pg=5&topic=nuclear&topic_set=
5. UN Documents Gathering a body of global agreements, Our Common Future, Chapter 7: Energy: Choices for Environment and Development Retrieved February 17, 2014 from <http://www.un-documents.net/ocf-07.htm>
6. Nuclear Power compared to other sources (2011, March 26). Retrieved March 3, 2014 from <http://deregulatetheatom.com/2011/03/nuclear-power-compared-to-other-sources/>

TECHNOLOGY OF PROCRESSING URANIUM HEXAFLUORIDE USING TO AMMONIUM FLUORIDE

E.I. Kurchenko

Scientific Supervisor: Docent, c. c. s., R. I. Kraydenko

Linguistic Advisor: Senior teacher, N.V. Demianenko

Tomsk Polytechnic University, Russia, Tomsk, Lenin str., 30, 634050

E-mail: evgenii@tpu.ru

Abstract

Currently in production technology of hexafluoride uranium has some problems connected with the expenses for its production and safety. Uranium – 235 has extensive use in separation of isotopes, because it is only one volatile compound of uranium wherein fluoride which has only one isotope. At the present time production technology of UF₆ needs a lot of elemental fluorine and this requires more money. [1]

In this science work we examined the ability of production of hexafluoride uranium in connection with ammonium fluoride, which is received by extracting the fluorine ion from depleted hexafluoride uranium. This process offers the challenge to utilize accumulated depleted hexafluoride uranium. In Russian there are hundreds of tons of accumulated depleted hexafluoride uranium.

Key words: *Uranium hexafluoride, depleted uranium, triuranium octoxide, ammonium fluoride.*

Introduction

The object of the work is to develop a method of obtaining hexafluoride uranium in connection with ammonium fluoride which is received by extracting the fluorine ion from depleted hexafluoride uranium, and also to convert depleted UF₆ to safe form for storage.

Development

Currently in Russian there is based obtaining of uranium hexafluoride. It is fluorination to triuranium octoxide in connection with elemental fluorine by reaction (1):

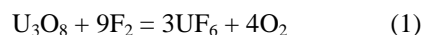

This technology has some disadvantageous, namely it is a lot of fluorine for fluorination and high aggression technologic of gas (mix of hexafluoride and oxygen). [2]

Also a technological scheme has been developed, which got its spread in American manufacturing, wherein uranium dioxide is exposed to hydrogen fluorine with formation of uranium tetrafluoride, after that uranium hexafluoride is exposed to fluorination by elemental fluorine with formation of UF₆ by reaction (2) and (3):

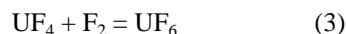
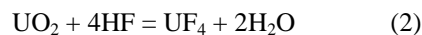

However this method has some disadvantageous which are connected with the usage of hydro fluoride and separation hydro fluoride – water mix. [3]

In the developed technology one considered the possibility of fluorination of triuranium ocoxide by ammonium fluoride without prior recovery, since the decomposition of ammonium fluoride is followed by

hydrogen formation, which restores the uranium fluoride to uranium dioxide. This process can be expressed by the formula:

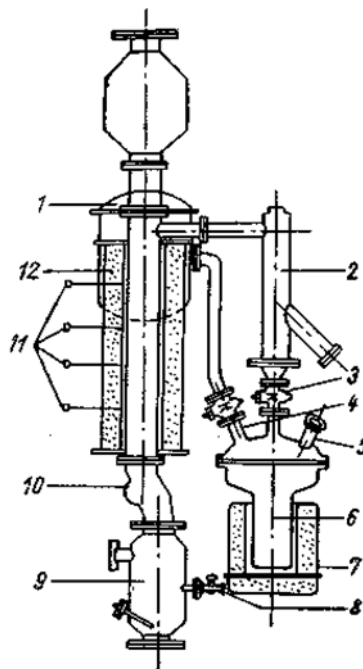

Fig. 1. Vertical reactor for breakerless fluorination in connection with steams of ammonium fluoride.

1 — condenser; 2 — gas filter for ammonium fluoride; 3, 4 — shut-off cocks; 5 — port for ammonium fluoride embark; 6 — reactor for sublimation ammonium fluoride; 7 — incinerator; 8 — input noble gas; 9 — box for product; 10 — equipment for ex-denning; 11 — thermocouples; 12 — vertical burner

When properly using this technology it is possible to obtain a qualitative product when there is low content of uranium dioxide fluoride and ammonium fluoride. The final product UF_4 is produced by purity of about 99,4 %. This product is possible to use for getting uranium hexafluoride and uranium oxides.

The process of fluorination in connection with steams of ammonium fluoride is possible to realize in vertical reactor (fig. 1). [2]

This fluorination technology was developed in 1967 and then it did not have actual use, but currently this method is possible to connect with processing of depleted uranium hexafluoride. Depleted uranium hexafluoride is a waste product of fuel production for nuclear power plants. [3]

Fluorine ion is extracted from depleted UF_6 while uranium is converted to triuranium octoxide in the combined technology. The method consists in dissolving UF_6 in water to give a solution of HF and UO_2F_2 (5). The received hydro fluoride is exposed to gas – liquor with formation of solution of ammonium fluoride (7).

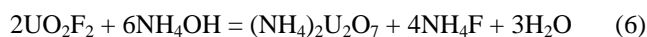
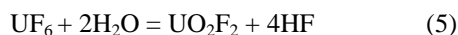

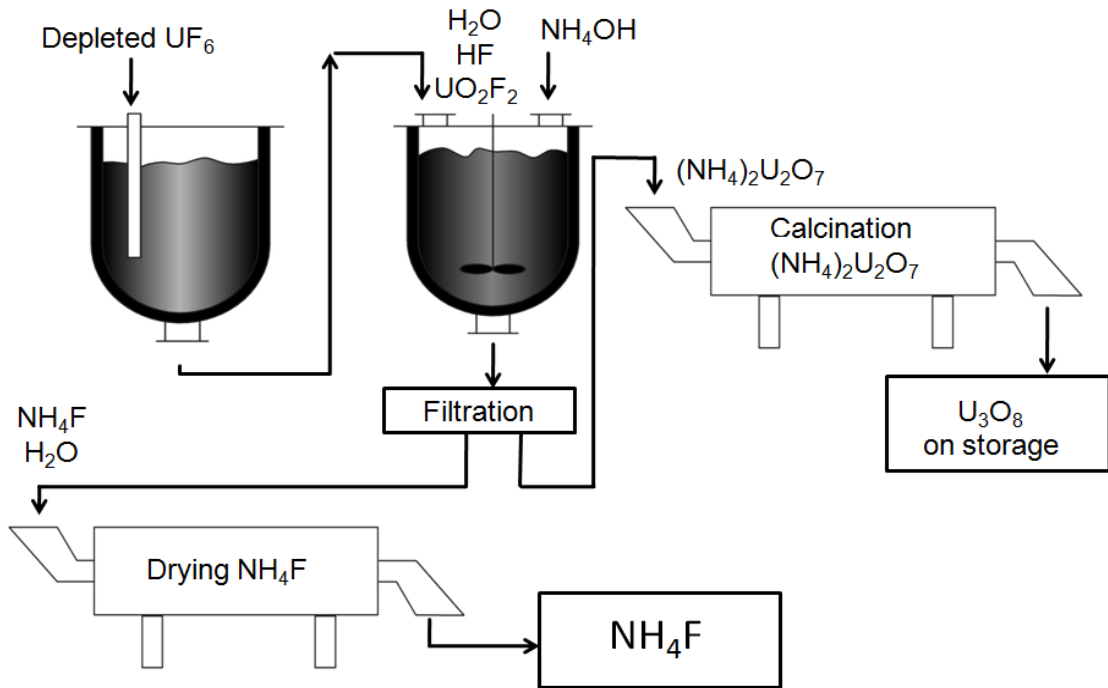

The solution is processed with ammonia water to obtain a solid diuranate of ammonium and solution of NH_4F (6). Ammonium diuranate is separated by filtration from the solution of ammonium fluoride and calcined to uranium oxide. U_3O_8 is possible to use in uranium metallurgy.

The solution was evaporated to a solid ammonium fluoride (7). The process scheme is shown in Fig. 2.

Fig. 2. Scheme processing of depleted uranium hexafluoride with obtaining ammonium fluoride

Ammonium fluoride obtained by the reaction of (7) will just be used in fluorination technology which has been described above in reaction (4). This technology will make it possible to use depleted uranium hexafluoride in a factory for obtaining ammonium fluoride. Besides, saving on HF and F_2 will increase the volume of production of UF_6 . As we can see in fig. 2, after calcination of ammonium diuranate $(\text{NH}_4)_2\text{U}_2\text{O}_7$ the triuranium octoxide is formed, which is safer than depleted uranium hexafluoride for storage in the fresh air. For realization of the process we can use typical and cheap equipment of chemical technology.

It must be also specified that the reduction and fluorination by ammonium fluoride vapors the explosiveness of production decreases. In case of depressurization of apparatus ammonium fluoride is desublimated in the atmosphere without presenting a significant risk to personnel.

In the process of research we calculated mass balance of a hydrolysis of depleted uranium hexafluoride to obtain ammonium fluoride (fig. 3) and mass balance of uranium hexafluoride obtaining using ammonium fluoride.

Looking at fig.3 and we can see that when processing about one ton of depleted UF_6 , we get 631 kg of ammonium fluoride and 886 kg of triuranium octoxide. In the result 96 % of fluorine ion can be extracted from depleted uranium. It must be noted that the resulting ammonium fluoride is 3 times cheaper than the

factory's one.

Fig. 4 shows the material balance of ammonium fluoride fluorination of uranium oxide, which contains uranium - 235. With the help of ammonium fluoride, which was obtained in the first process diagram (Fig. 3) we can be fluorinate 1198 kg of triuranium octoxide to obtain 1138 kg of uranium tetrafluoride.

Conclusion

Thus, with the help of developed technological scheme it is possible to utilize depleted uranium hexafluoride. Depleted uranium is converted to triuranium octoxide form and extracted fluorine ion in the form ammonium fluoride will allow to expand production of uranium hexafluoride. Also the developed scheme for UF_6 is safer than the existing methods of preparation. Moreover the technological scheme is based on typical and cheap equipment of chemical technology.

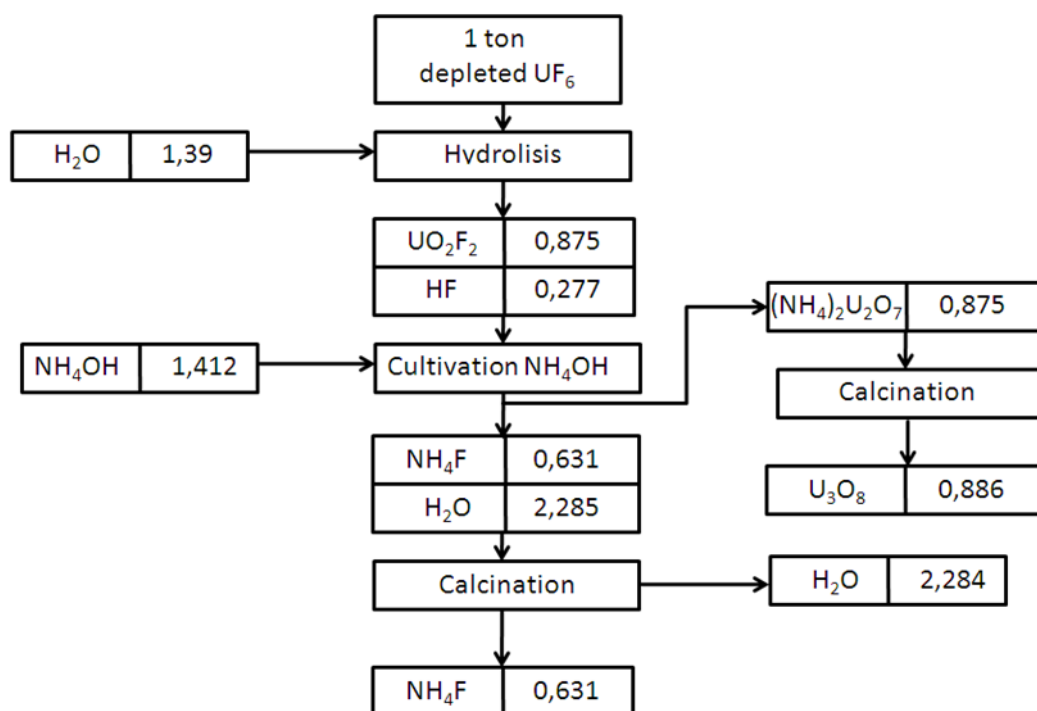

Fig. 3. Scheme of mass balance of processing hydrolysis depleted uranium hexafluoride and ammonium fluoride obtaining

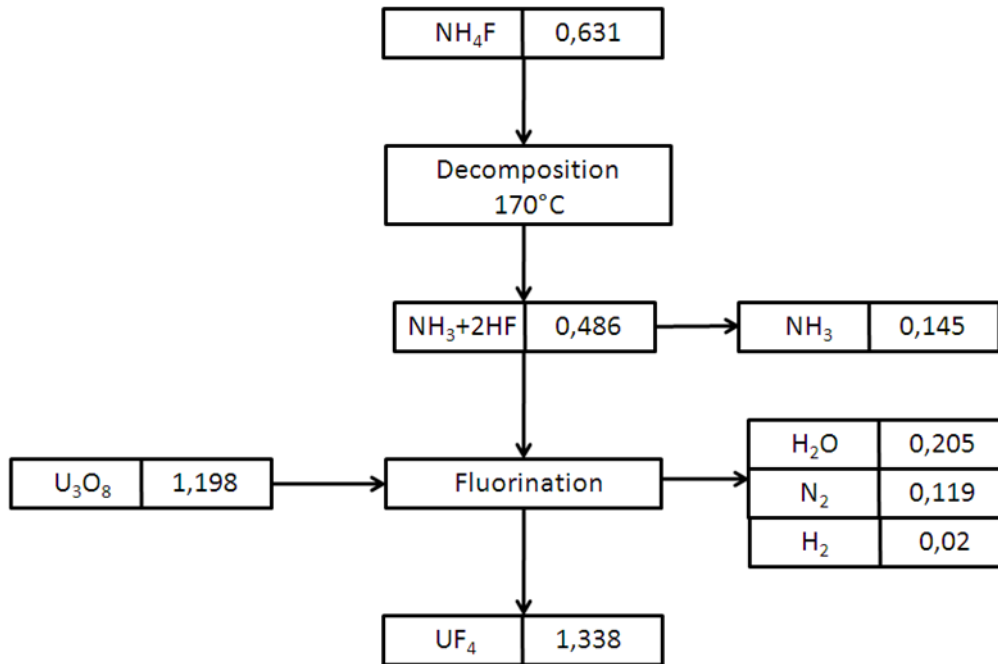

Fig. 4. Scheme of mass balance of processing fluorination triuraniumoctoxide in connection with ammonium fluoride

References

1. R. DeWitt: Uranium hexafluoride: A survey of the physico-chemical properties, Technical report, GAT-280; Goodyear Atomic Corp., Portsmouth, Ohio; 12. August 1960.
2. Galkin N.P., Mayorov A. A., Vertyin U.D. Chemical and technology fluoride compounds of uranium. – M.: Publishers of literature in province nuclear science and technology, 1961. – 348 p.
3. Alexandra C. Miller Depleted Uranium, CRC Press Taylor & Francis Group 2007
4. Copy of letter of Minister Russian Federation on atomic power №01-4114 от 25.07.2003.

PRODUCTION OF MOLECULAR COMPOSITES BASED ON POLYTETRAFLUOROETHYLENE AND TITANIUM DIOXIDE

A.L. Lashtur

Scientific Supervisor: Asst. A.S. Kantaev

Linguistic Advisor: Senior teacher, N.V. Daneykina

Tomsk Polytechnic University, Russia, Tomsk, Lenin str., 30, 634050

E-mail: all1@tpul.ru

Abstract

The method of creation of composition material on the basis of molecular mixture of polytetrafluoroethylene and TiO₂, by absorption of the products of thermal decomposition of polytetrafluoroethylene and ammonium hexafluorotitanate on ammonium water is offered. Molecular distribution of TiO₂ in the structure of composite is well-proven by the X-ray diffraction analysis. Influence of the entered connection on the yield of titanium-fluoropolymeric composite from a gas phase is researched.

Key words: polytetrafluoroethylene, ammonium hexafluorotitanate, titanium-fluoropolymeric powder, thermal destruction, process kinetics, thermal analysis, structural analysis.

Introduction

Composition materials on the basis of polytetrafluoroethylene (PTFE) and titanium oxide possess a number of useful properties excelling clean PTFE by their characteristic features. It is necessary to notice that introduction of oxygen in the form of oxides into the structure of polymeric chain promotes heat-resistance, increases durability at compression and hardness of material by several times [1]. A few methods of filler introduction into PTFE have been worked out, but all of them are based on mechanical mixing of two components and do not allow obtaining complete homogenization of composite [2].

Obviously, the properties of a composite can develop to a full degree only during complete homogenization of its components, and finding such a method will allow making breakthrough in area of materials science of composition materials. In case of PTFE well-known methods of homogenization, such as the method of introduction of one component into the solution of the other is impossible because of absence of universal solvent for PTFE and TiO₂.

The analysis of physical and chemical properties of PTFE and compounds of titanium showed that ammonium hexafluorotitanate (NH₄)₂TiF₆, as well as PTFE, evaporates at a temperature higher than 300°C and condenses quantitatively at cooling.

Thus, it is possible to get material consisting of a condensate with molecular mixing of PTFE and (NH₄)₂TiF₆. Important property of ammonium hexafluorotitanate is that it can react with ammonia and ammonium water on the reaction given below (1).



Processing of molecular mixture of condensed PTFE and (NH₄)₂TiF₆ with ammonium water will allow getting molecular mixture of PTFE and TiO₂. Ammonium fluoride is easily removed by dissolution [3].

The aim of research was the development of a method of quantitative introduction of titanium dioxide into a polymeric matrix from PTFE and technology of receiving molecular composite of PTFE and TiO_2 . Preliminary research shows that mixture of powdery PTFE and $(\text{NH}_4)_2\text{TiF}_6$ are sublimated with formation of fluoropolymeric powder, which has an atom of titanium of the given titanium-fluoropolymeric powder (of TFPP) in its composition.

For the achievement of the set aim it is necessary to solve the following tasks:

- 1) Research the influence of amount of introduced $(\text{NH}_4)_2\text{TiF}_6$ on the output of TFPP;
- 2) Research the influence of introduced $(\text{NH}_4)_2\text{TiF}_6$ on the process of thermal decomposition of PTFE;
- 3) Study properties of synthesized TFPP by means of methods of thermal analysis.

Development and results

Research was conducted for mixtures containing 1, 5, 10, 15, 20 and 30% by mass of $(\text{NH}_4)_2\text{TiF}_6$ and 99, 95, 90, 85, 80 and 70% by mass of PTFE accordingly.

Condensation of TFPP from gas mixture of $(\text{NH}_4)_2\text{TiF}_6$ and PTFE sublimation with the subsequent precipitation by ammonium water depends on proportion of a mixture loaded in a reactor. The degree of condensation of thermal destruction products increases with the increase of concentration of $(\text{NH}_4)_2\text{TiF}_6$ in a mixture.

The degree of condensation of thermal destruction products of PTFE in gaseous medium of $(\text{NH}_4)_2\text{TiF}_6$ increases with the increase of concentration $(\text{NH}_4)_2\text{TiF}_6$ in an initial load. From experimental data it is evident, that the highest yield YFP is observed at introduction of 30% $(\text{NH}_4)_2\text{TiF}_6$ into PTFE.

When the concentration of $(\text{NH}_4)_2\text{TiF}_6$ increases to 30% the yield of the final product (YFP) of about 40% by mass from the initial sample weight of mixture in a hard phase is provided, and percentage of gas losses is slightly more than 20% , but residue in a reactor makes about 40% by mass.

When the concentration of $(\text{NH}_4)_2\text{TiF}_6$ decreases to 20% by mass, losses in the form of gases increase to 30% and the yield of the final product also decreases by 10%. The percentage of residue changes proportionally to the losses in a reactor.

Thus, it is obvious that the optimal amount of addition of $(\text{NH}_4)_2\text{TiF}_6$ makes 30% by mass, which provides the maximum yield of the final product (YFP).

Joint thermal decomposition of PTFE and sublimation of $(\text{NH}_4)_2\text{TiF}_6$ at a temperature of 500°C and higher possesses high speed of process, while the sublimation of addition $(\text{NH}_4)_2\text{TiF}_6$ accelerates the process of decomposition, which can be noted on the lines at 500°C and below and is expressed by a smooth concavity on the area from 30% to 60%.

The presence of the second component $(\text{NH}_4)_2\text{TiF}_6$ practically does not affect the speed of process. Time of complete decomposition and sublimation is practically the same as for other fluorides examined within the framework of this work.

On the basis of the resultin data dependences (2) of the degrees of joint sublimation of addition $(\text{NH}_4)_2\text{TiF}_6$ and thermal decomposition of PTFE (α) on the time (τ) and temperature (T) within the interval of temperatures 475...525°C. Process is well described by equalization of contracting sphere.

$$\alpha = 1 - \left(1 - 1,32 \cdot 10^8 \cdot \exp \left[-\frac{174453}{R \cdot T} \right] \cdot \tau \right)^3$$

(2)

Apparent energy of sublimation process activation of 30% $(\text{NH}_4)_2\text{TiF}_6$ and thermal decomposition of 70% PTFE makes the 174kJ/mol. As a result the limiting step of this process kinetics of chemical reaction. A method of process acceleration is temperature increase.

Thermal decomposition of TFPP powders differs from PTFE and FORUM® the product of thermal degradation of PTFE [7]. The temperature of weight loss start is the same for all the samples and is 160 °C and the final temperature of the end of mass change of the samples is 550 °C.

Step weight change is characteristic for all samples of TFPP and two fractions with different thermal stability are clearly seen. Low-molecular phase comprises 15-20 % of the original sample. Endothermic peak, located in the region of 380 - 390 °C on DSC (differential scanning calorimetry) curve, is observed for all samples. This is due to removal of crystal water from the inorganic component of fluoropolymeric composite, [8], wherein a peak is characteristic only for concentrations of mixture of above 10 %.

As a result of structural and thermal studies of resultin composite materials of TFPP it has been found out that the polymeric component has a similar structure to the material FORUM® [7], but also has individual characteristics: the presence of an amine group in the structure, the presence in the form of TiO_2 .

Conclusion

1. A method which allows working out the technology of synthesis of molecular composite on the basis of PTFE and TiO_2 is offered.
2. It is most optimal to use $(\text{NH}_4)_2\text{TiF}_6$ for introduction of TiO_2 in PTFE.
3. Optimal correlation of PTFE + 30 % by mass $(\text{NH}_4)_2\text{TiF}_6$.
4. The yield of the final product in a hard phase makes no less than 40 % by mass.
5. As a source of PTFE it is possible to use wastes, shaving and wastes from PTFE.
6. Degrees of decomposition (of thermal degradation) of PTFE with addition of 30 % by mass $(\text{NH}_4)_2\text{TiF}_6$ on temperature and time is described by equalization

$$\alpha = 1 - \left(1 - 1,32 \cdot 10^8 \cdot \exp \left[-\frac{174453}{R \cdot T} \right] \cdot \tau \right)^3$$

7. The proposed method is characterized by simple hardware design, lack of expensive reagents and can be implemented in industry.

References

1. Loginov BA. (2007) The Amazing World of fluoropolymers / BA Loginov. - M., p.128
2. Yuri Panshin Fluoroplastics / Pashnin YA, Malkevich SG, Dunaevskaya.(1978) - Leningrad: Khimiya.
3. Kantaev AS, Borisov VA. (2010) Getting organofluoric powder. Materials 16 All-Russian Conference of Physics Students and young scientists, p.728
4. Bouzник, VM . (2008) The morphology and structure of micron and nanoscale powders of polytetrafluoroethylene resultin CVD / VM Bouzник, VG Kuryavyi // Rus. chem. Well. (J. Ros. Chem. Islands about them. DIMendeleyev). Т. LII. - № 3. – p. 131.
5. Andreev, AA. (2008) Development of technology for fluoride of titanium dioxide pigment from ilmenite: dis. ... Cand. tehn.: 05.17.02 / Andreev Artyom. - Tomsk., p.141.
6. Bellamy, L.(1957) Infrared spectra of molecules / L. Bellamy. - Moscow: Izd. of literature, p. 445.

**FUEL ELEMENTS OF HYDROGEN POWER INDUSTRY
AS A SOURCE OF EFFECTIVE ENERGY**

M.V. Nikolaev, A.K. Kushebina, A.Y. Fedotkin

Language advisor: Senior teacher U.A. Smirnova

Tomsk Polytechnic University, Russia, Tomsk, Lenin str., 30, 634050

E-mail: mvn4@tpu.ru

In recent years the public discusses a question of energy resources. According to expert opinions, stocks of oil have to suffice approximately for 50 years. Further oil production will be conducted from unattractive sources, the cost of its production and cost of the final petrochemical products will increase [4].

Certainly, some countries can not worry about a century, and then it will be possible to use gas and coal, however it won't be enough and it will be necessary to look for new energy sources.

The countries with rather small stocks of natural resources deal with these problems. For example, in Kazakhstan following the results of 2012 electricity generation from wind, hydro and solar energy made 1 trillion kWh [5].

Such examples make us think about the subject of alternative power engineering which at present totals more than 5 points:

- solar energy
- geothermal energy
- wind energy
- tidal energy
- biofuel

The solar power stations use energy of the sun for receiving current from photo cells, or warm a copper which spin the turbine with the generator. The geothermal power uses transformation of internal heat of the earth into electricity. The wind power – wind is used for spinning of a rotor of the electricity generator. The tidal power engineering uses energy of waves of the seas and oceans as an electricity source. Besides, the types of electric engineering based on a difference of temperatures and biofuel is developed[2].

The great attention is drawn by fuel elements – the devices turning chemical energy of reaction into electric current. Some of them are very small and use alcohol for the work, but some of them are capable of working on technical hydrogen and air under certain conditions and there are a lot of such resources on the Earth. Besides, such elements can produce heat. It can be used to increase efficiency of resources use.

Before learning positive and negative aspects of fuel elements we should understand common processes in fuel elements and some definitions.

Fuel element (FE) is device in which the energy of fuel and oxidizer turns into electricity. In fact, it is a galvanic cell because of the presence of reacting substances and electrolyte. But the common difference is that the fuel element demands a continuous supply of active components. Galvanic cell has a stock of energy. If it exhausts the energy allocation will stop.

General view of current producing reaction, common for all elements is the following:

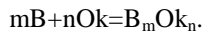

Where m and n – integers, B – fuel, Ok – oxidizer

Such reaction is common for fuel elements and thermal electric generators. In thermal electric generators frequent collision of active components is necessary. In fuel elements there is a directed movement of electrons from a reducer to an oxidizer. It can be described by several formulas:

Fuel oxidation:

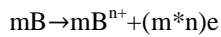

Oxidizer restoration:

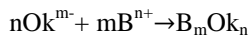
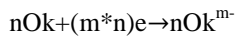

We can see that in both cases the results are the same but in the second case there is a production of current.

Fuel elements with alkaline electrolyte

In fuel elements with alkaline electrolyte KOH solution is mainly used. We can write current making reaction:

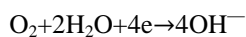
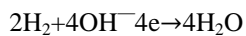

These fuel elements work on pure hydrogen and oxygen that is expensive. However, the mass of installation and cost of energy can be reduced, using air instead of oxygen. But air needs to be cleared of carbon so that electrolyte didn't react, bringing to decrease in conductivity:

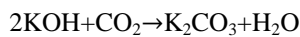

Potassium hydroxide was chosen in view of high electric conductivity that it is possible to see in figure 1.

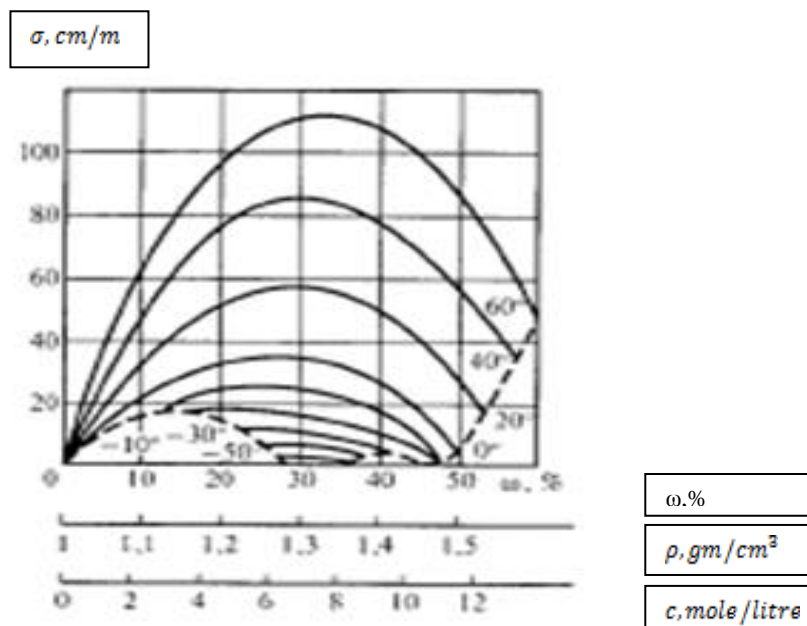

The dependence of the electrical conductivity of potassium hydroxide solutions on concentration and temperature. Concentration is expressed as a percentage of mass fractions and moles per litre. Also listed density solutions.

The conductivity peak occurs apparently at about 60 degrees Celsius is the share of concentration of 6-8 mol per litre. The first such battery was presented by the English scientist F. Bacon in the 1950th, it worked at 200 degrees Celsius; hydrogen and oxygen pressure was 2-4MPas. The element had a good density of current up to 4 kA/sq. m at a voltage of 0.9 V, the battery power was near 5 kW. However, the resource of this device sufficed to work 100 hours and because of high pressures it was necessary to increase installation weight. Similar elements were applied in meteorological stations, television stations, buses and even in the submarine where the power of the battery was 100kW [3].

Comparison of alkaline fuel elements is presented in table 1.

Company	Temperature°C	Anode catalyst	Cathode catalyst	Current density, kA/m ²	Voltage, V	Power density, kW/m ²	Durability, th.hrs.
Varta and ISET	60	Ni	Ag	1	0,8	0,8	>4
Siemens	80	Ni	Ag	0,8-2	0,9-0,8	0,7-1,6	8,5
Union Carbide	65	Pt	Spindle	1	0,85	0,85	8
ELENKO	70	Pt	Pt	1	0,7	0,7	20
Allins Chalmers	90	Pt-Pd	Ag	2,5	0,85	2,25	5
UTC (Apollo)	200-260	Pt	Pt	0,25-2	1-0,8	0,25-1,6	2,5
UTC (Shuttle)	92	Pt-Pd	Au-Pt	2,7	0,86	2,2	5

Ural Electrochemical Integrated Plant	98	Pt	Pt	2,2	0,92	2,1	5
---	----	----	----	-----	------	-----	---

So, the main advantages of alkaline fuel elements are: availability and high electric conductivity of electrolyte, the inexpensive production technology, ability to work at a temperature up to -30 degrees Celsius, reliability and environmental friendliness.

Shortcomings: need for pure hydrogen and use of expensive platinum catalysts.

Methanol fuel elements

Practical experiments showed that methanol is oxidized on platinum electrolyte in acid solutions:

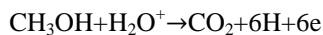

Because of rather weak parameters methanol fuel elements can't compete with alkaline and firm polymeric, however, found the application. Storage of pure hydrogen and oxygen is expensively and ineffectively. From this point of view methanol is much more favorable as at the room temperature it is liquid. Therefore it is simple to store it. These advantages are used in portable equipment, for example, for power supply of laptops, as theoretical energy which can be received from methanol kilogram is above, than at lithium.

Advantages: ease of storage of methanol, low pressure, easy replacement of sources of methanol.

Shortcomings: toxicity of methanol, by-products of reaction worse properties of the catalyst.

Fuel elements with solid oxide electrolyte

Strong substances are used as electrolyte. For example, the dioxide of zirconium stabilized by teroxide of yttrium, $(\text{ZrO}_2)_{0.92}(\text{Y}_2\text{O}_3)_{0.08}$.

Because of features of such electrolyte acceptable conductivity is reached at a temperature about 1100K. This feature allows using such fuel element as heat source. The part of energy of fuel passes into heat which is simple to use at such temperatures for heating and for receiving additional electricity using a gas turbine (hybrid installation).

Main reactions of a solid oxide fuel element:

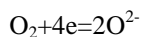
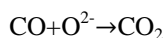
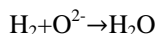

Working pressure of such fuel elements is 300-400 kPas. The Siemens-Westinghouse firm achieved power near 200 W on fuel kilogram. Density of power made to 3kW per sq. m, a resource about 60000 hours.

Parameters of environmental friendliness of hybrid electrical units are presented in table 2 given below.

Options	Power HybEU	
	300	100

Efficiency, %	More 55	More 55
Power of electricity	244	805
Power of gas turbine	65	220
Summary power	300	1014
CO ₂ , kg/MWhr	Less 350	Less 350
NO _x , ppm	Less 0.5	Less 0.5
CO ₂ , ppm	0	0
SO _x , ppm	0	Less 0.1
Particles, pp,	0	0
Noise, 5 metredb	<75	<75

Advantages: ecological safety, high efficiency, possibility of use in a heat supply, use as fuel not only hydrogen, but also various biogases.

Shortcomings: high working temperature because of which it is necessary to buy the qualitative materials compatible at thermal expansion is necessary.

Fuel elements with firm polymeric electrolyte

In such fuel elements the ionic conductor is the membrane, capable to carry out hydrogen ions. For example, using electrodes made of platinum grids the element gave out tension 0,6 V at the current density 1,25 kA per sq. m at a temperature about 60 degrees Celsius.

Main reactions:

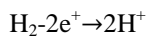

Such fuel element was applied in Gemini spaceships and the power was 1.8 kW, a stock of 90 kg of oxygen and hydrogen was enough for two-week flight. Modern samples are capable to give out 3 kA per sq. m at a voltage of 0.8 V.

Increasing the temperature with 50 to 90 degrees Celsius tension of each element rises by 30-50 mV, but the resource considerably decreases. Therefore the used temperature is about 70 degrees. At pressure increase from 100 kPas to 500 kPas there is an increase in density of current on 50 mA per sq. cm, but power consumed by the compressor. Therefore gas pressure usually isn't higher than 200 kPas.

Advantages: use as fuel of technical hydrogen or air, high specific power, firm electrolyte.

Shortcomings: high cost of a membrane because of the content of platinum in it in large numbers, small service life because of accumulation of impurity in a membrane [1].

Conclusion

This review gives a clear understanding that fuel elements can provide with electricity and heat in the future. However, mankind shouldn't be focused only on this problem, there are many options of alternative

power engineering and it is better to use them together.

References

1. Korovin N.V. Toplivnie elementy i electrohimicheskie energoustanovki // M.: Izdetel'stvo MEI. - 2005. - 280 p.
2. <http://ria.ru/documents/20091113/193404769.html>
3. <http://www.cleandex.ru/articles/2007/08/24/fuelcell-comparative>
4. <http://vz.ru/economy/2012/11/2/605487.html>
5. <http://www.inti.kz/ekspertnye-obzory/marketingovyj-obzor-otrasli-alternativnoj-energetiki.php>
<http://vz.ru/economy/2012/11/2/605487.html>

FAST REACTOR BREST-300

A.E. Novoselov, E.V. Stolov, V.S. Nefedov

Scientific Supervisor: Assistant N.V. Liventsova

Linguistic Advisor: Senior teacher O.P. Kabrysheva

Tomsk Polytechnic University, Russia, Tomsk, Lenin str., 30, 634050

E-mail: nefedov.vs@gmail.com

Abstract

This paper describes the nearest future of nuclear power engineering in terms of fast reactor - BREST-300. The article shows its design, characteristics and benefits of fast reactors. Even modern reactors with slow neutrons have high energy rates, but there are some problems such as rarity of Uranium -235 and large amounts of waste. The Russian development of BREST-300 is able to solve some of the problems.

Key words: BREST-300, fast reactor(FR), loop, fuel assembly (FA), closed nuclear fuel cycle (CFC), thermal power, electric power, fuel lifetime.

Introduction

Future large-scale nuclear power (NP) based on FR in a CFC, can arrest the growth of fossil fuel consumption, provide the bulk of electricity production increase, and "... resolve the problems of energy supply for sustainable human development, non-proliferation of nuclear weapons and environmental improvement of the planet..." [8] stated Russian President V.V. Putin at the UN Millennium Summit in 2000.

Nuclear power will not be socially acceptable unless it gains high safety and security, interpreted broadly as:

- freedom from the constraints of fuel resources;
- impossibility of severe accidents with uncontrollable power growth, loss of cooling, fires and explosions, accompanied by radioactive and toxic releases at a level requiring public evacuation;
- technological support of the non-proliferation regime;
- environmentally safe closing of the fuel cycle and final waste disposal without upsetting the natural radiation equilibrium;
- ability to compete economically with alternative energy sources. [5]

Thanks to contributions made by a number of institutes and research centers, all the above requirements are met by the innovative nuclear technology under development at NIKIET now. This technology relies on the concept of BREST – a naturally safe FR with nitride fuel, lead coolant and a special onsite closed fuel cycle. [5]

Design of a Nuclear Power Plant with a BREST-300 Reactor System

The thermal scheme is a two-loop scheme, the first loop containing lead with the required purity and the second loop containing water–steam with supercritical parameters. [3] The second loop is nonradioactive, it consists of a feed-water system, steam generators, the main steam pipes and a single turbine unit. The water chemistry in the second loop, adopted on HPP blocks with supercritical pressure, is a neutral-oxygen regime with no de-aerator. [4] The K-300-240-3 serially produced turbine facility developed

by the Leningrad Metal Works contains a steam turbine with systems for rotating the shaft, lubrication, regulation, and hydraulic lift of the rotors, and others. In contrast to existing designs of nuclear power plants, the second loop is not required to remove heat in an emergency situation. [4] The buildings of the main loop are able to withstand an earthquake, they were designed taking account of the norms for designing earthquake-resistant nuclear power plants. For design purposes, an earthquake of magnitude 6 was assumed and the maximum earthquake was taken to be magnitude 7 on the MSK-64 scale. [1] To ensure reliable operation of the structures, the spatial system of the reactor buildings is designed in monolithic reinforced concrete. The building was designed to be symmetric with dimensions in the plane 65 *74 m, separated by crossed vertical bearing diaphragms to decrease inertial seismic forces. [2]

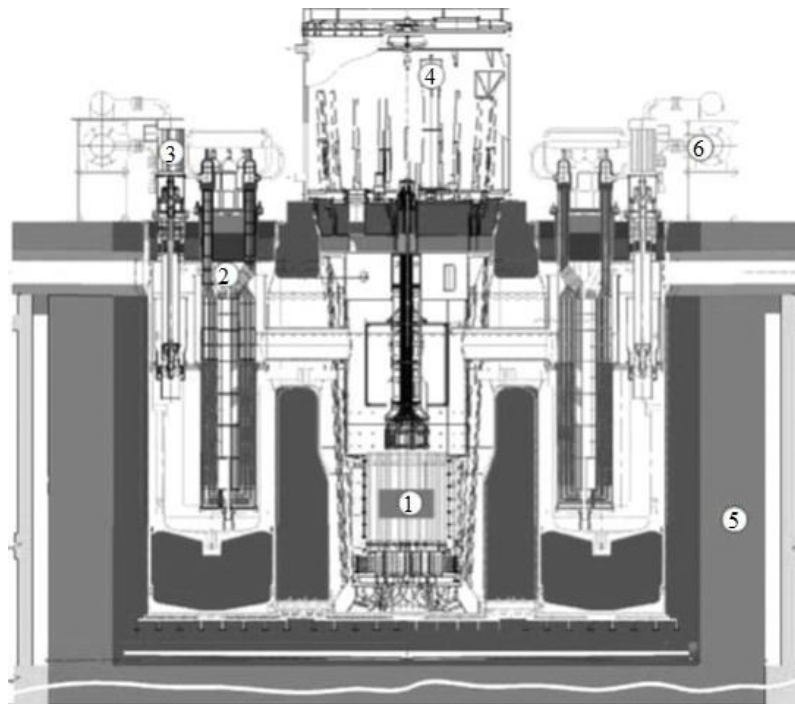

BREST-300 reactor: 1) core; 2) steam generator; 3) pump; 4) reloading machine; 5) shaft; 6) cooldown system. [2]

Characteristics of BREST-300 [9]

Thermal power, MW	700
Electric power, MW	300
Fuel assembly design	Shrouded
Number of fuel assemblies	199
Core diameter, mm	2650
Core height, mm	1100
Fuel rod diameter, mm	9.7; 10.5
Fuel rod pitch, mm	13.0
Core fuel	(U+Pu+MA)N
Fuel inventory, (U+Pu+MA)N, t h.m.	24.1

Mass of (Pu)/ (Pu239+Pu241), t	3.1/2.2
Fuel lifetime, eff.days	1800
Cycle-averaged CBR	~1.05
Average/max. fuel burnup, MW·d./kg	53/84
Inlet/outlet lead temperature, °C	420/540
Maximum fuel cladding temperature, °C	650
Water-Vapor temperature at SG inlet/outlet, °C	340/505
Pressure at SG outlet, MPa	18
Design life, years	30

Benefits of BREST

- natural radiation safety from any possible accidents on internal and external reasons, including sabotage, not requiring evacuation; [6]
- long-term (almost unlimited in time) ensuring fuel resources through the effective use of natural uranium; [6]
- U blankets are excluded (replaced by Pb) to rule out production of weapons-grade Pu; [5]
- environmentally friendly energy production and disposal of radioactive waste without upsetting the natural radiation balance; [6]
- economic competitiveness due to natural plant safety and fuel cycle technologies, rejection of complex engineering systems security. [6]

Natural radiation safety is provided by:

- using of high boiling ($T = 2024 \text{ K}$), radiation-resistant and low-activated lead coolant which do not react with water and air, which prevents fires, chemical and thermal explosions in the event of depressurization of contour, steam leakages and any temperature coolant; [6]
- use of jacketless FAs with wide grid fuel rods in the active zone of moderate power (maximum $\sim 200 \text{ M}^*\text{W}/\text{m}^3$), excluding loss of heat removal at the local overlap of flow area in FAs providing a high level of natural circulation of coolant; [6]
- choice of the design of active zone with lead reflector the composition and geometry of which provide a complete reproduction of fuel (ACC-1); [6]
- use of passive protection systems of direct-acting reactor which regulates flow rate and temperature of the coolant at the inlet and outlet of the active zone; [7]
- a passive system of external air emergency cooling of reactor through the body; [6]
- high heat storage capacity of the lead circuit. [6]

Competitiveness

- Thanks to the simpler design of the facility, its safety systems and to efficient utilisation of nuclear fuel and generated heat, a plant with a BREST-type reactor is expected to be economically competitive.
- Low lead pressure in the circuit allows using an integral configuration of the circuit components in a concrete pool, which was tentatively shown to reduce the construction costs.

- On-site fuel cycle arrangement is also likely to be economically beneficial owing to the shorter out-of-pile cooling and transportation time, which will eventually lead to a reduction in the recycled fuel quantity – one of the greater contributors to the fuel cycle costs.

Conclusion

The BREST-300 development efforts carried out to pave the way for commercial reactors of this type and thereby to lay a foundation for large-scale nuclear power, show that such reactors can provide: [10]

- radical improvement of safety with elimination of the most dangerous radiation accidents by combining the fast reactor's properties and its components with features of natural safety;
- unlimited fuel resources and independence from U mining.
- reduction of the proliferation risk;
- conclusive solution of the radioactive waste problem;
- ability to compete with other types of power generation. [5]

References

1. V.V. Orlov, V.S. Smirnov, A.I. Filin, et al., "Deterministic safety of BREST reactors," in: 11th International Conference on Nuclear Technology, Tokyo, Japan, April 20–23, 2003, ICONE11-36415.
2. A. G. Glazov, P. P. Polyéktov, V. F. Leont'ev, and R. S. Karimov, "Fuel cycle for BREST reactors. Solution of RAO and nonproliferation problems," *ibid.*, ICONE11-36405.
3. V. S. Smirnov, A. V. Lopatkin, I. P. Matvienko, et al., "Experimental and computational validation of the neutron-physical characteristics of a BREST-OD-300 reactor," *ibid.*, ICONE11-36412.
4. A.I. Filin, B.B. Kubintsev, Yu.V. Nesterov, et al., "Main technical solutions for the second loop for a nuclear power plant with a BREST-OD-300 reactor system," in: Proceedings of TsKTI on the Improvement of the Electrical Equipment, Energy Technologies, Thermal Schemes, and Operating Regimes of Power Plants, St. Petersburg (2002), pp. 15–18.
5. V.S. Smirnov "Lead-Cooled Fast Reactor BREST – Project Status and Prospects" 2012
6. V.I. Boiko, V.V. Sidlovskiy, V.N. Mescheryakov, I.V. Shamanin, F.P. Koshelev, D.G. Demyanyuk: "Perspective nuclear fuel cycles and reactors of new generation", Tomsk Polytechnic University. -Tomsk: Publishing House of Tomsk Polytechnic University, 2009. - 518.
7. I.N.Bekman "Nuclear Industry" Lecture Course, Lecture 14. "Advanced Nuclear Reactors".
8. Statement by Russian President Vladimir Putin at the Millennium Summit of the United Nations (in Russian) // International Law. - 2000.
9. Атомные электростанции высокой безопасности и экономичности с быстрым реактором со свинцовым теплоносителем БРЕСТ с пристанционным топливным циклом.
http://www.niket.ru/index.php?option=com_content&view=article&id=101%3A2011-03-18-13-33-18&catid=3&Itemid=4
10. БРЕСТ: быстрый реактор со свинцовым теплоносителем и пристанционным топливным циклом.
<http://www.atomic-energy.ru/technology/36000>

OBTAINING OF NANOPARTICLES OF CDS BY PHOTOLYSIS OF $\text{Na}_4[\text{CD}(\text{S}_2\text{O}_3)_3]$ AQUEOUS SOLUTIONS

K.V. Obmuch

Scientific advisor: PhD, Associate professor N.B. Egorov

Language advisor: Senior teacher N.N. Zyablova

Tomsk Polytechnic University, Russia, Tomsk, Lenin str., 30, 634050

E-mail: kvo@tpu.ru

Abstract

On the basis of X-ray diffraction and chemical analysis data, it was found that cadmium sulfide exhibiting the "size effect" is formed during the UV irradiation of aqueous solutions of cadmium thiosulfate. Sulfate ions and hydrogen ions accumulate in the aqueous solution. It was shown that the yield of cadmium sulfide is affected by the concentration of thiosulfate ions in the solution. The overall equation of photolysis of cadmium thiosulfates is proposed.

Thiosulfates of transition and heavy metals are interesting for their different stereochemistry, catalytic properties and capable to forming metals or metal sulfides during decomposition. The latter property allows the use of compounds of thiosulfate as precursors for the synthesis of nanoparticles of the respective metals or metal sulfides. Currently, the nanoparticles of metals and metal sulfides have a greater interest associated with their optical, catalytic, photocatalytic, electrical and biological properties.

Among ordinary semiconductors, cadmium sulfide (CdS) as a result of nearly perfect single crystal form - one of the most used and studied semiconductors. Under normal conditions, grained CdS is a direct wide band gap semiconductor with a cubic structure. At a temperature of 300 K band gap grained monocrystalline and polycrystalline CdS foil 2.42 eV. CdS nanoparticles are proposed as a material for photoresists phosphors and scintillators.

Irradiation of aqueous solutions of thiosulfates of heavy metals (Pb, Cd, Ag) UV light results in their decomposition with the formation of solid products [1, 2]. Photolysis of aqueous solutions of a complex lead thiosulfate [1] proposed as a photosensitive base for visible direct-darkening photographic image [3] has been most extensively studied. The photolysis of solutions of the complex lead thiosulfate results in the formation of lead sulfide, lead sulfate, and elemental sulfur [4]. In addition, hydrogen ions accumulate in the solution.

In this work, we investigated the possibility of obtaining nanoparticles of cadmium sulfide in the photolysis.

EXPERIMENTAL

Cadmium thiosulfate solutions were obtained by mixing aqueous solutions of sodium thiosulfate and cadmium chloride.

A DRT-350 mercury quartz lamp with unfiltered radiation was used as a source of UV light.

X-ray diffractograms were recorded on a Shimadzu XRD 6000 diffractometer, $\text{CuK}\alpha$ -radiation. In this case, the concentrations of the initial sodium thiosulfate and cadmium chloride solutions were 1 mol/l.

Cadmium sulfide formed during photolysis was separated by centrifugation. The CdS formation procedure was repeated Repeatedly to obtain an amount sufficient for analysis.

The cadmium content in the products was determined by chelatometric titration with disodium ethylenediamine tetraacetate. A mixture of Eriochrome Black with sodium chloride was used as an indicator [5]. For sulfur determination, the photolysis products were treated with aqua regia. In this case, all sulfur present in the precipitate was converted into sulfate sulfur, which was determined by the gravimetric method after the precipitation of sulfate ions with a barium chloride solution [6].

Electronic absorption spectra (EAS) were recorded in a quartz cell with an optical path length of 1 cm on an Uvikon-943 spectrophotometer in the range λ 190–900 nm. The concentration of cadmium thiosulfate solutions in spectral measurements was 10^{-3} mol/l.

The IR spectra of solid photolytic products were recorded with a Nicolet-5700 IR Fourier spectrometer in the range $400\text{--}4000\text{ cm}^{-1}$. The samples were prepared in the form of potassium bromide disks.

The pH value was measured with an EV-74 ion meter using a glass electrode with a silver/silver chloride reference electrode.

RESULTS AND DISCUSSION

During UV irradiation, aqueous cadmium thiosulfate solutions take a brown–green color. Elemental analysis of the precipitate produced by the photolysis showed that the Cd : S ratio in the solid is not constant and depends on a procedure and duration of its washing. Examination of the obtained precipitate by means of IR spectroscopy showed that absorption bands at 1149 , 1004 , and 628 cm^{-1} , characteristic of the thiosulfate ion [7], and absorption bands at 3469 and 1622 cm^{-1} characteristic of water are present in the IR spectrum. Repeated washing with water and water acidified to pH 2 does not result in the removal of thiosulfate ions from the photolysis product (Fig.1, curve 1).

It is impossible to remove impurities from the photolytic precipitate unless the solid is subjected to longterm heating in water or in 0.1 M HCl (Fig.1, curve 2). In this case that, the color of the photolysis product changes from brown–green to bright yellow.

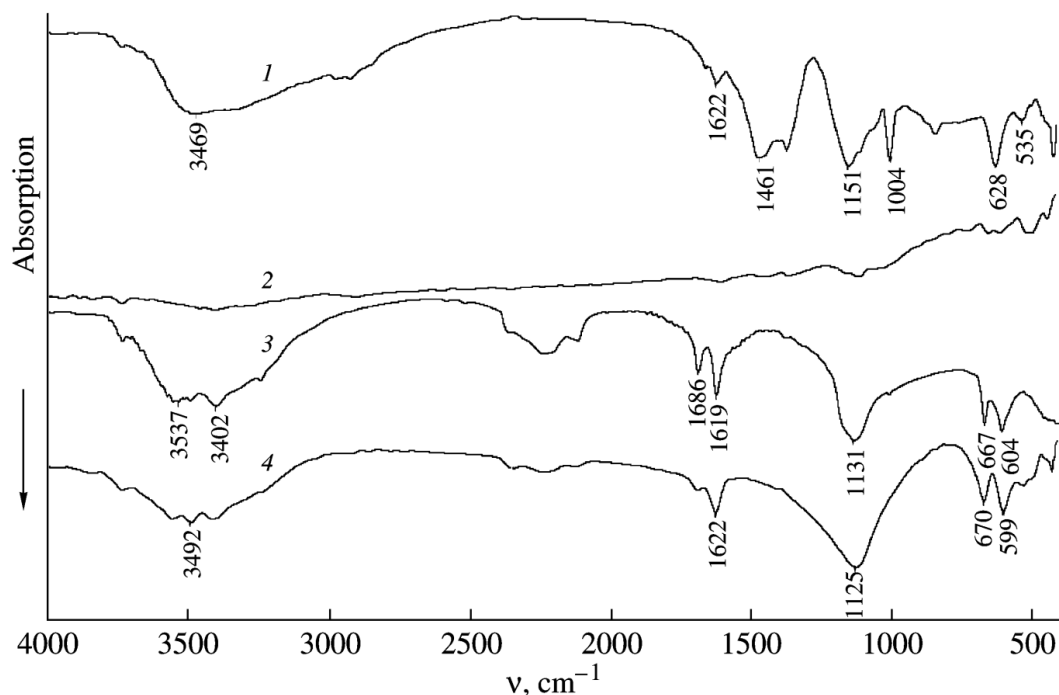

Fig.1. IR spectra of (1) the cadmium thiosulfate photolysis product, (2) the cadmium thiosulfate photolysis product washed by heating in 0.1 M HCl, (3) the precipitate obtained via addition of a CaCl₂ solution to a photolyzed cadmium thiosulfate solution, and (4) calcium sulfate.

As shown in table of X-ray diffraction data, the cadmium thiosulfate photolysis product washed by heating in 0.1 M HCl produces a set of reflections including the basic reflections of CdS.

Chemical analysis of the precipitate cleaned of thiosulfate ions by washing showed that it has a Cd : S molar ratio of 1 : 1. Thus, it should be concluded that the base substance forming the solid product during the photolysis of cadmium thiosulfate aqueous solutions is CdS.

Table 1. XRD data for the product of photolysis washed by heating in 0.1 M HCl.

CdS [8]		Photolysis product	
2θ	I, %	2θ	I, %
26.514	100	26.53	100
30.709	22	30.71	20
43.983	47	43.98	44
52.094	35	52.10	36
54.598	5	54.61	10

Figure 2 presents the differential electronic absorption spectra of CdS formed in the photolysis of cadmium thiosulfate at a concentration of 10⁻³ mol/l. As is apparent from Fig. 2, the maximum of CdS absorption is at 260 nm. The edge of the absorption band in the case of crystalline CdS occurs at 400 nm.

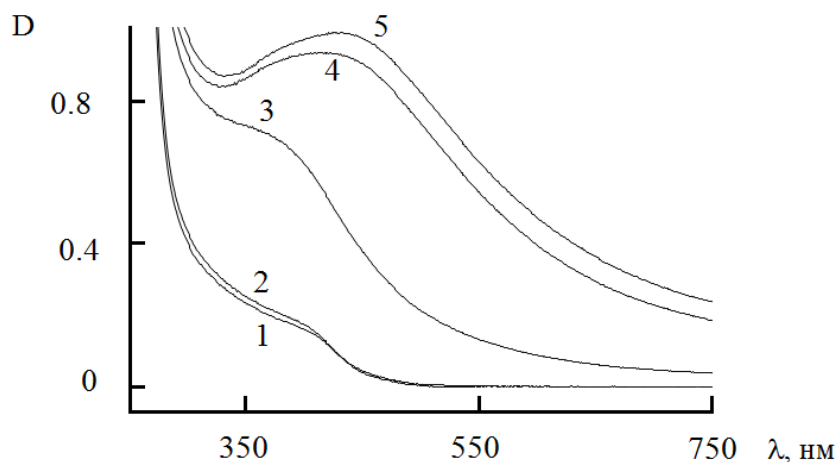

Fig. 2. Electronic absorption spectra of CdS formed during the photolysis of a 10^{-3} mol/l cadmium thiosulfate solution ($\text{Cd}^{2+} : \text{S}_2\text{O}_3^{2-} = 1 : 2$) for (1) 1, (2) 2.5, (3) 5, (4) 7 and (5) 9 min of irradiation.

It is known [9] that a shift of a maximum in an optical spectrum toward shorter wavelength is the “size effect” and manifests the formation in a system of nanoparticles with a higher value of the band gap energy than in the case of corresponding bulk specimens. Thus, it may be concluded that the product of the UV photolysis of aqueous cadmium thiosulfate solutions is CdS nanoparticles exhibiting the size effect.

It is known [10] that the electronic and structural properties of CdS particles change with a decrease in their size and these changes affect their physical and chemical properties. The difficulty of washing thiosulfate ions off CdS formed during photolysis indicates its high capability to adsorb charged ions on the surface. It may be assumed that, being adsorbed on the surface of CdS, thiosulfate ions create a shell around CdS and thereby impede the aggregation of the particles.

According to published data [7], the ν_a vibration mode at $>1175 \text{ cm}^{-1}$ (S bridging), $1175\text{--}1130 \text{ cm}^{-1}$ (S coordinated), $\sim 1130 \text{ cm}^{-1}$ (ionic $\text{S}_2\text{O}_3^{2-}$), $<1130 \text{ cm}^{-1}$ (O coordinated), as well as a shift in the ν_s (SO_3) vibration above 1000 cm^{-1} (S coordinated) and below 1000 cm^{-1} (O coordinated), is most useful in determining the structure of the thiosulfate ion in compounds with heavy metals on the basis of IR data. The band frequencies in the IR spectrum of the cadmium thiosulfate photolysis product (Fig. 1, curve 1) indicate that thiosulfate ions are coordinated to CdS through a sulfur atom, with the thiosulfate ion acting as a monodentate ligand.

As a rule, organic compounds having a long hydrocarbon radical and a terminal functional group in their molecules are admixed to a reaction medium for stabilization of nanosized particles.

PRODUCTS OF PHOTOLYSIS

In the given system, thiosulfate ions simultaneously both act as a source of sulfur for CdS formation and a stabilizer of CdS nanoparticles formed during photolysis.

It is known that, depending on the $\text{S}_2\text{O}_3^{2-}$ concentration in a solution containing Cd^{2+} ions, three thiosulfate compounds CdS_2O_3 , $[\text{Cd}(\text{S}_2\text{O}_3)_2]^{2-}$ and $[\text{Cd}(\text{S}_2\text{O}_3)_3]^{4-}$ can be formed [11]. A study of the dependence of the CdS yield on the $\text{S}_2\text{O}_3^{2-}$ concentration in a photolyzed system showed that the maximum

yield of CdS is observed at a $S_2O_3^{2-} : Cd^{2+}$ ratio of 2 to 3 (Fig. 3). This finding can be explained by a lower stability of $[Cd(S_2O_3)_2]^{2-}$ and $[Cd(S_2O_3)_3]^{4-}$ complexes toward UV irradiation in aqueous solutions, as compared with the photostability of CdS_2O_3 . A further increase in the amount of $S_2O_3^{2-}$ ions that are not included into the inner sphere of coordination complexes in the solution leads to a reduction in the yield of CdS, a change that is apparently caused by absorption of a portion of radiation by $S_2O_3^{2-}$.

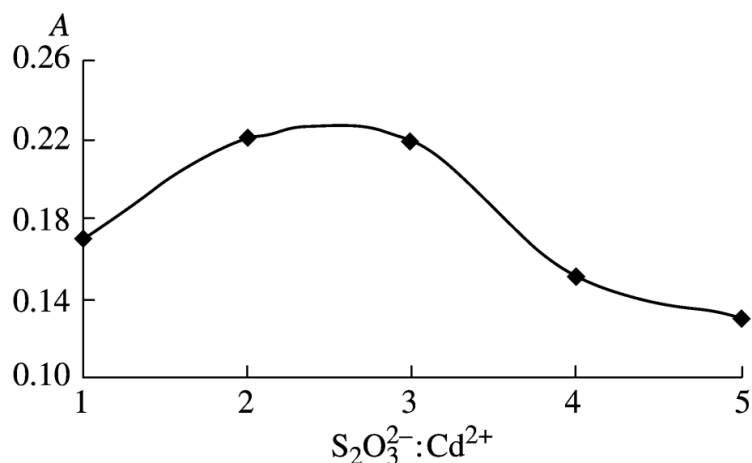

Fig. 3. Dependence of the absorbance at $\lambda = 260$ nm of photolytically produced CdS on the $Cd^{2+} : S_2O_3^{2-}$ molar ratio. The initial cadmium thiosulfate concentration is 10^{-3} mol/l and the irradiation time is 5 min.

Figure 1 (curve 3) shows the IR spectrum of a substance obtained after the addition of a $CaCl_2$ solution to the photolyzed cadmium thiosulfate solution. Preliminarily, CdS was separated by centrifugation. For comparison, Fig. 1 (curve 4) presents the IR spectrum of $CaSO_4$ prepared by adding $CaCl_2$ solution to a solution of Na_2SO_4 . As is seen from Fig. 1, the IR spectrum of the substance obtained from the photolyzed cadmium thiosulfate solution strongly resembles that of $CaSO_4$. This observation allows the conclusion that another product of cadmium thiosulfate photolysis is the sulfate ion SO_4^{2-} .

The initial cadmium thiosulfate solutions have a weak acid or neutral reaction (depending on the concentration of thiosulfate ions). During photolysis, hydrogen ions accumulate in the solutions (Fig. 4).

In [4], we have found that the formation of elemental sulfur (which was extracted by *n*-hexane from solid products) occurs during UV irradiation of aqueous solutions of a lead thiosulfate complex. Treatment of the solid products of cadmium thiosulfate photolysis with *n*-hexane did not show the presence of elemental sulfur.

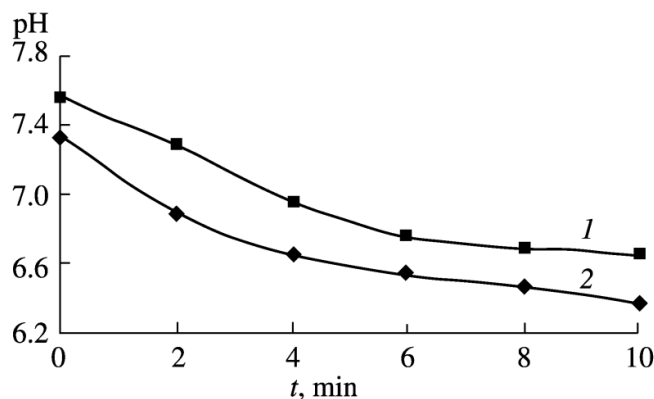
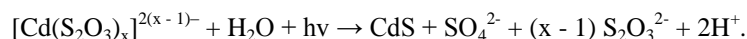

Fig. 4. Change in the pH of photolyzed (1) 0.1 M and (2) 0.01 M cadmium thiosulfate solutions. Molar ratio $\text{Cd}^{2+} : \text{S}_2\text{O}_3^{2-} = 1 : 2$.

Thus, the final products of photolysis of aqueous cadmium thiosulfate solutions are CdS , SO_4^{2-} , and H^+ . The results allow us to propose the following overall equation of cadmium thiosulfate photolysis processes:



On the basis of X-ray diffraction and chemical analysis data, it was found that cadmium sulfide exhibiting the “size effect” is formed during the UV irradiation of aqueous solutions of cadmium thiosulfate. Under certain conditions, is possible to obtain nanosized cadmium sulfide CdS .

REFERENCES

1. Egorov, N.B., Cand. Sci. (Chem.) Dissertation, Tomsk: TSU., 2003.
2. Egorov, N.B., Eremin, L.P., and Larionov, A.M., Abstracts of Papers, IX Mezhdunarodnaya konferentsiya “Fiziko-khimicheskie protsessy v neorganicheskikh materialakh”, (IX Int. Conf. on Physicochemical Processes in Inorganic Materials) Kemerovo, 2004, vol. 1, p. 129.
3. Eremin, L.P., USSR Inventor’s Certificate no. 1182901, Byull. Izobret., 1998, p. 365.
4. Eremin, L.P. and Egorov, N.B., Zh. Nauchn. Prikl. Fotogr., 2003, vol. 48, no. 2, p. 23.
5. Schwarzenbach, G. and Flaschka, H., Die komplexometrische Titration, Stuttgart: Ferdinand Enke, 1965.
6. Busev, A.I. and Simonova, L.N., Analiticheskaya khimiya sery (Analytical Chemistry of Sulfur), Moscow: Nauka, 1975.
7. Freedman, A.N. and Straughan, B.P., Spectrochim. Acta, 1971, vol. 27A, p. 1455.
8. Mirkin, L.I., Spravochnik po rentgenostrukturnomu analizu polikristallov (Handbook of X-ray Analysis of Polycrystals), Moscow: Fizmatgiz, 1961.
9. Gusev, A.I. and Rempel’, A.A., Nanokristallicheskie materialy (Nanocrystalline Materials), Moscow: Fizmatlit, 2000.
10. Gubin, S.P., Kataeva, N.A., and Khomutov, G.B., Izv. Akad. Nauk, Ser. Khim., 2005, no. 4, p. 811.
11. Lur’e, Yu.Yu., Spravochnik po analiticheskoi khimii (Analytical Chemistry Handbook), Moscow: Khimiya, 1979.

ION-EXCHANGE PROCESSES UNDER THE INFLUENCE OF MAGNETIC FIELD

S.V. Perminov, E.V. Bospala

Scientific Supervisor: Prof., Dr. V.F. Myshkin

Language Advisor: A.V Tsepilova

Tomsk Polytechnic University, 634050, Lenin Av. 30 Tomsk, Russia.

E-mail: Perminov_sereg@mail.ru

Abstract

In this paper, the research results of the influence of magnetic field on the ion-exchange processes are reported. For the first time, it is experimentally demonstrated that magnetic field increases the electro dialysis current.

Keywords: magnetic field, electrolyte solution, polarization, water solution, water dipole, ion-exchange resin.

INTRODUCTION

Modern society imposes stringent requirements on water parameters. Increasing water needs will require the development of innovative purification technologies. Water treatment, when seawater surface or underground water are used as the source, may be performed using ion exchange membrane and electrolysis methods. Polarization and the decrease in the conductivity of the membrane, release of gasses at the electrodes (electrolysis), duration of the process and the destruction of the electrodes reduce the effectiveness of electro dialysis water purification technique. Magnetic field can change the equilibrium in the «ion exchanger – solution» system. Therefore studying of the influence of magnetic field on ion exchange processes is important.

The main goal of the research is to study the influence of magnetic field on the electro dialysis processes and the equilibrium in «ion exchange resin – solution» system.

EXPERIMENTAL RESEARCH

In order to examine the influence of magnetic field on the electro dialysis process an experimental setup was constructed. It includes: a three-chamber dialyzer, an amplifying circuit, two DC power sources, electric power cables, the measuring resistance, two permanent magnets, recording devices (milliammeter, an oscilloscope). Schematic diagram of the experimental setup is shown in Fig. 1.

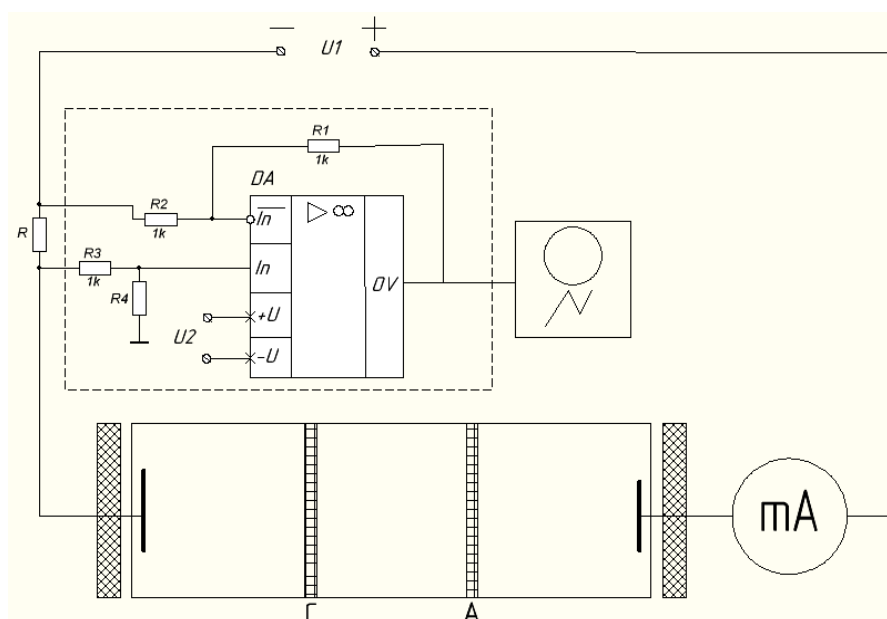

Figure 1. Schematic structure of the experimental setup.

Electrodialysis cell consists of three chambers: the brine, the anode and cathode. The volume of each chamber is 15 ml. It was made of polymethylmethacrylate. This material has good resistance to acids and alkalis. Two Nd-Fe-B magnets with remanent magnetization 1.2 T were used. Anion-exchange membrane (MA-40) and cation-exchange membrane (MC-40) separates the anode and cathode chambers respectively. Schematic diagram of the structure of the experimental setup is shown in Fig. 1.

Serially with the electrochemical cell, resistor R, was placed into the circuit, aimed to record signal which allows to evaluate the current flows in the circuit. Nominal resistance and power dissipation of the resistor are 0.95 Ohms and 0,125 Watts respectively. The signal recorded from this resistor is then amplified on amplifying circuit and transferred to an oscilloscope. As an amplification circuit was used differential amplifier circuit on the operational amplifier LM358, allowing to strengthen small, against interference signals. Amplification factor for this circuit is calculated as:

$$K = \frac{R1}{R2}$$

The nominal values for the resistors of the circuit must satisfy the following equation:

$$\frac{R1}{R2} = \frac{R3}{R4}$$

In our experiment, it was enough to set amplification factor = 10. Nominal resistance of

$$R1, R4 = 1,2 \text{ MOhm}; R2, R3 = 120 \text{ kOhm}$$

were used.

As the electrolyte, filling the central chamber, NaCl solution with a concentration of 10 g/l was used. The cathode and anode chamber was filled with distilled water. The potential difference, applied to the electrodes is 10 V, the current stabilization - 0.3 A. The registration began with turning on the DC sources, oscilloscope

voltage signal proportional to the current flow.

Each series of experiments included electro dialysis with magnetic fields of two polarities with respect to the direction of the electric field and without the field. Sodium chloride solution was prepared once for all measurement cycles at a known concentration.

LeCroy oscilloscope was used for registration of current in the circuit through the electro dialysis cell. Current dependence of time, in the circuit, with magnets fixed in the longitudinal direction is shown in Fig. 2. Repeatability of graph shapes is observed.

It was revealed that when the magnet's North Pole is oriented towards the cathode, the effect is stronger. In the magnetic field there is a simultaneous compression of the graph along the time axis and an increase in the maximum current value. The area under the curve depends on the polarity of the magnetic field. With the same number of ions that can be explained by the influence of magnetic field on water electrolysis at the electrodes.

The effect of the magnetic field can be related to polarization of the dipoles of water. Magnetic field acts on ions in thermal motion. The hydrogen atoms of the water molecules are oriented along the magnetic field lines due to the Lorentz force. The cross section of the water molecule decreased in the direction of the electric field [1].

Orientation of water molecules must change the diffusion rate of ions in an aqueous solution in a magnetic field. We registered the rate of propagation of NaCl solution and Ni(NO₃)₂ along the height of the water column in a magnetic field for estimating the influence of magnetic field on the diffusion coefficient. For this two rectangular cuvettes were set into Jamin interferometer: one with distilled water and another with saturated saline solution at the bottom. The diffusion coefficient was evaluated by the movement of the leading edge of a saturated solution, which was registered at the wavelength of a helium-neon laser of the interferograms.

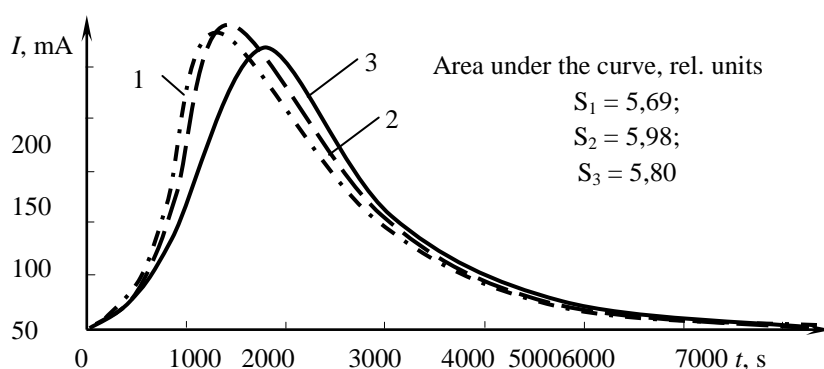

Figure 2. Electro dialysis current dependence on time. 1 - North Pole near the cathode, 2 - South Pole near the cathode a, 3 - without a magnetic field.

Selection of compounds can be explained by the fact that NaCl contains mainly spin nuclei, but Ni(NO₃)₂ has spinless nuclei. It has been proven that the magnetic field is less than 1.2 T, and its orientation relative to the direction of diffusion does not influence diffusion coefficient in the range of measurement error. It

is known that the magnetic field does not affect the electrical conduction in solution [2].

CONCLUSION

Research results suggest the following:

1. The external magnetic field of 1.2T increases electro dialysis current by 9%.
2. The influence of the magnetic fields of less than 1.2 T on the diffusion of inorganic ions in aqueous solutions has not been detected.

REFERENCES

1. Myshkin V.F., Khan V.A., Izhoikin D.A. et al. Analysis of the processes caused the magnetic field influence on a structure and properties of water. //Scientific Journal of the Kuban State Agrarian University. – 2012. – №07(81). Access mode: <http://ej.kubagro.ru/2012/07/pdf/48.pdf>. (in Russian).
2. Ming-Yuan Lin, Lih-Wu Hourng, Chan-Wei Kuo The effect of magnetic force on hydrogen production efficiency in water electrolysis// International journal of hydrogen energy 37 (2012) 1311-1320.
3. Helfferich F., Resins (The basics of ion exchange)// transl. from germ. // Moscow, Foreign Literature Publishing House- 1962. -490.
3. Zagorodni A.A., Ion Exchange Materials: Properties and Applications, Amsterdam, Elsevier, 2006, 496p.

EVALUATION OF THE EFFICIENCY OF SLUDGE LIGNIN PLASMA DISPOSAL PROCESS

K.G. Piunova

Scientific Supervisor: PhD, Associate professor A.G. Karegin

Language Advisor: Teacher A.V. Tsepilova

Tomsk Polytechnic University, Russia, Tomsk, Lenin str., 30, 634050

E-mail: piunova93@mail.ru

This article shows the review and analysis of literature on methods of sludge lignin utilization. It is the product obtained after processing of cellulose. As a result of the calculations the optimal compositions of water, organic materials with mechanical impurities with adiabatic combustion temperature of about 1200 K were determined. With the help of obtained results experimental studies were carried out in a plasma catalytic reactor and the reactor operation was optimized. The results can be used to build industrial plants on the basis of plasma catalytic reactors for utilization of sludge lignin.

INTRODUCTION

Lignin as a component of wood is the hardest waste, which is formed in chemical processing of wood at paper plants and hydrolysis plants [1].

On the other hand it is a potential raw material resource for many countries. According to the International Institute of lignin (International Lignin Institute) annually in the world would be about 70 million tons of technical lignin but not more than 2% of it is used for industrial, agricultural and other purposes. The rest is burned in power plants or disposed of in the cemeteries as sludge lignin [2]. There is currently no comprehensive technical solutions for waste sludge lignin, although a review of the scientific literature demonstrates the growing interest of researchers to this raw material resources.

EXPERIMENTAL

Efficient and environmentally safe disposal of such waste can be achieved by plasma utilization of combustible organic water-based compositions based on sludge lignin having adiabatic combustion temperature $T_{ad} \approx 1200^\circ \text{C}$.

Figure 1 shows the effect of sulfite lignin content and solids (ash) on the adiabatic combustion temperature of different aqueous-organic compositions.

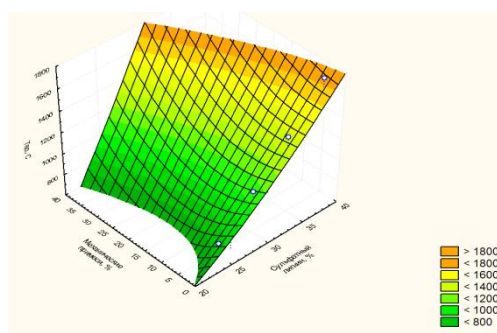

Figure 1. Effect of lignin and sulfite solids adiabatic combustion temperature on the water-organic compositions based on lignin slurry.

The calculations determine the optimum composition, aqueous-organic compositions based on sludge - lignin Thad ≈ 1200 ° C. with different initial solids content (ash).

As a result of these calculations the optimal water-organic composition having an adiabatic combustion temperature of 1200 ° C and Thad \approx is determined providing environmentally safe disposal of sludge lignin: water organic composition (70% water: 30% sludge - lignin) .

To determine the optimal mode of the process under investigation equilibrium compositions of gaseous and condensed products of plasma utilization of optimal water-organic compositions based on lignin slurry were calculated. The licensed program TERRA was used for this purpose.

Calculations were carried out at a pressure of 0.1 MPa, a wide temperature range ($300 \div 4000$ K) and for different mass fractions of air plasma coolant ($0,1 \div 0,95$).

Figures 2 and 3 show the equilibrium compositions of gaseous and condensed products of optimum utilization of plasma composition water organic composition air plasma with a mass fraction of air plasma coolant 64%.

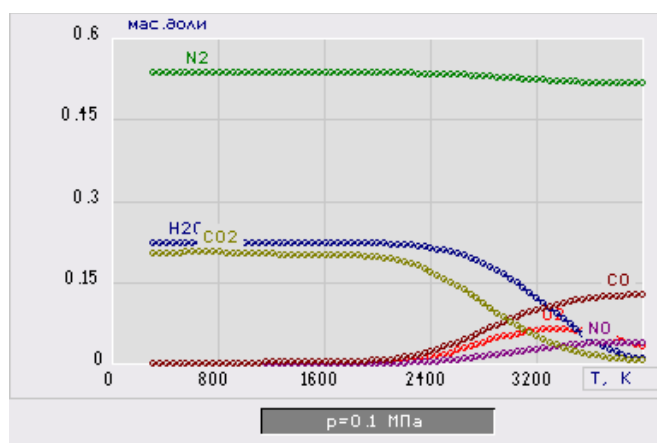

Figure 1. The equilibrium composition of gaseous products of the process of plasma utilization of water-organic compositions based on sludge lignin in air plasma (64 % of air, 36% of water organic composition).

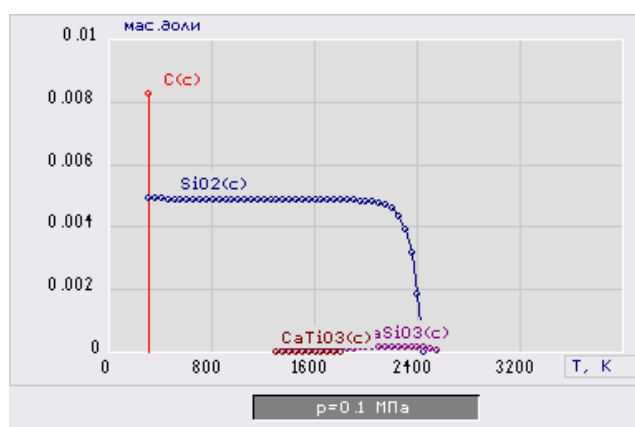

Figure 3. The equilibrium composition of condensed products of plasma recycling process of water-organic compositions based on sludge lignin in air plasma (64% air: 36% water organic composition).

The analysis of compounds in Figures 2 and 3 shows that when the mass concentration of the air plasma

coolant is 64% and the operating temperature is 1200 ± 100 K, gaseous N_2 , CO_2 and H_2O are formed. SiO_2 (c) is formed in the condensed phase. The presence of soot and CO indicate that the process of plasma utilization of the optimal water organic composition in air plasma with a mass fraction of air plasma coolant 64 % proceeds in a non-optimal mode.

Increasing the mass fraction of air of 64% (Fig. 3) to 66 % (Fig. 4) results in the disappearance of C (c), CO and NO, which indicates that the process of recycling sludge lignin in the form of water organic composition plasma with a mass fraction of air plasma coolant 66 % proceeds in the optimal mode.

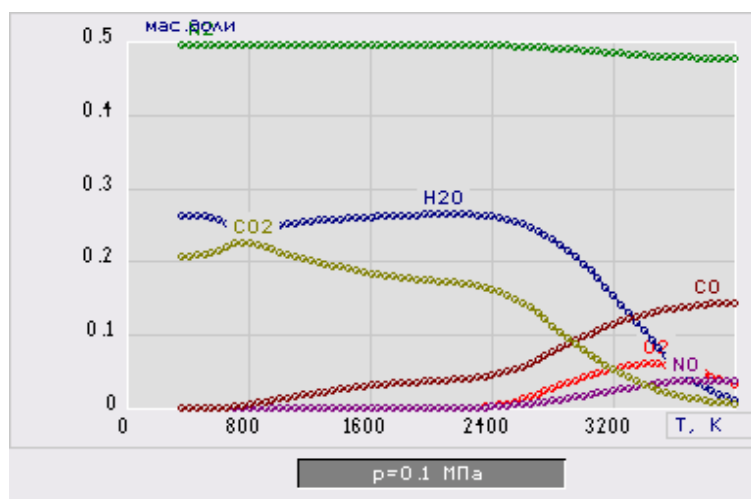

Figure 4. The equilibrium composition of the gaseous products of the process of plasma disposal of water-organic composition based on sludge lignin in air plasma (66 % air: 34% water organic composition).

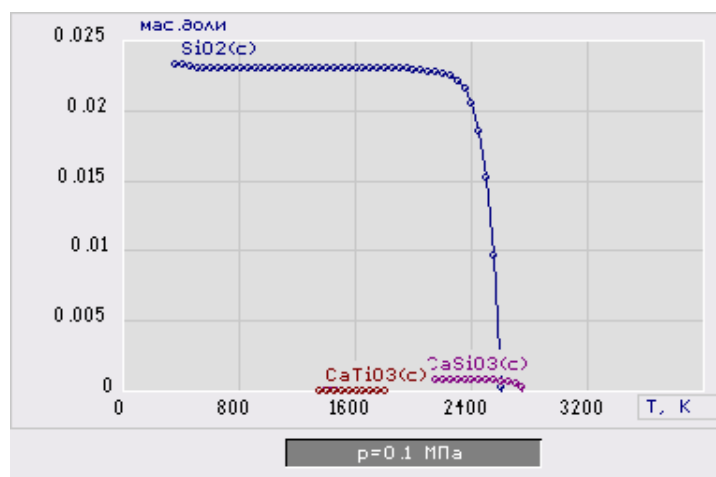

Figure 5. The equilibrium composition of condensed products of plasma recycling of water-organic compositions based on sludge lignin in air plasma (66% air: 34% water organic composition).

Figure 6 shows the effect of operating temperature and the content of lignin slurry on specific energy consumption for plasma recycling 1 kg SHL

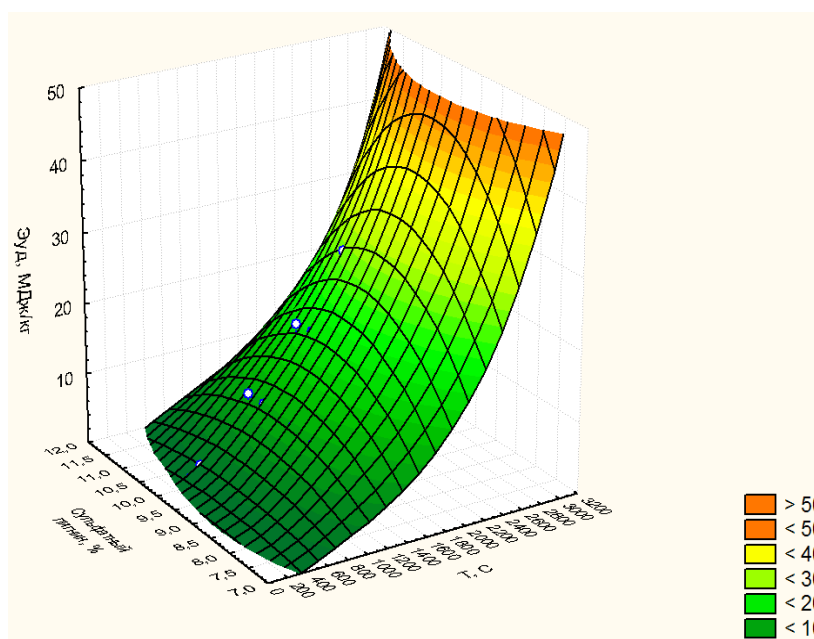

Figure 6. The influence of sludge – lignin content and process operating temperature on specific energy consumption for plasma recycling of 1 kilo of sludge lignin .

CONCLUSION

Taking into account the results obtained the following parameters can be recommended for practical implementation:

- The composition of the aqueous-organic composition must be as follows: 70% of water and 30% of sludge - lignin;
- The weight ratio of phases (66% of air : 34% of water organic composition);
- Operating temperature of the process should be 1200 ± 100 ° C.

REFERENCES

1. Sarkane K.V, Ludwig K. H, Lignins . - M. . "Forestry", 1975. - 632 p.
2. Bogdanov A.V, Rusetskaya G. D, Mironov A., Ivanova M. A. Comprehensive recycling pulp and paper industry. - Irkutsk: publishing house Irkutsk State Technical University, 2000 . – 227 p.
3. Kamaldinov O. D, Massow J. A. Preparation of vanillin from lignosulfonates . M., 1959. 38.
4. Hatakeyama H. Possibility of obtaining ecological polymers with the use of plant components// Petrotech. 2000. V. 23. №9. P. 724-730.
5. Wrzesniewska-Tosik K., Tomaszewski W., Struszczyk H. Manufacturing and thermal properties of lignin-based resins// Fibres and Text. East. Eur. 2001. V. 9. № 2. P. 50-53.
6. Celeghini R., Mauro L.F. Optimization of the direct liquefaction of lignin obtained from sugar cane bagasse// Energy Sources. 2001. V. 23. № 4. P. 369-375.

GENERATOR ANALOG AND DIGITAL SIGNALS

A.S. Popov

Scientific Supervisor: PhD, Associate professor A.V. Obkhodtsky

Language Advisor: Senior teacher N.V. Demyanenko

Tomsk Polytechnic University, Russia, Tomsk, Lenin str., 30, 634050

E-mail: asptomsktpu@gmail.com

Annotation: in this article, we will focus on the creation of printed circuit boards for electronic devices. In fact, a whole science with a lot of nuances, calculations, etc. In this article, we will only consider the tracing process for example emulator digital and analog signals.

The process of creating roads of the conductor on board called tracing or wiring. These roads allow interaction between the various elements of a PCB. Connection tracking is usually the final stage of the design and the design of electronic equipment is to determine the lines connecting the equipotential contact elements and components that make up the projected unit.

Tracing task is one of the most challenging in the general problem of design automation CEA. This is due to several factors, in particular to the variety of ways of implementing structural and technological connections. From a mathematical point of view, tracing - the most complex task of choosing from a huge number of variants of optimal solutions.

The main task of routing is formulated as follows: according to the given scheme to lay the required conductors on a plane (circuit board, chip etc.) to implement the predetermined engineering compounds taking into account the predetermined constraints. The main limitations are the width of the conductors and the minimum distance there between.

There are several tracing methods. For simple devices manual modes are mostly used, for more complex - automatic or interactive ones. Now let's consider an automatic and manual ways as an example.

Figure 1 showsthe device - anemulatorofdigitalandanalogsignals. This is a screenshot of the program P-CAD- 2006 PCB. There has not been applied trace, only elements of the device are arranged and organized communication between their findings. The task is to trace, to start an automatic method.

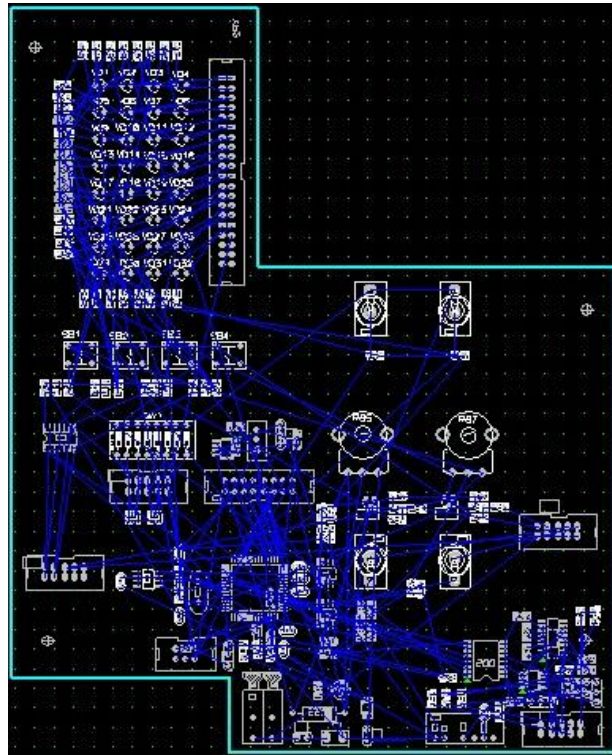

Figure 1 - emulator signals without trace

Figure 2 shows the result of automatic routing. It was performed using a standard automatic tracer embedded in P-CAD 2002. As a result, you can see many flaws. The most important thing - there should be no right angles to the road (Figure 3). When the conductor circuit board rotates through an angle of 90° can be reflected signal. This happens mainly because of the change of the width of current flow path. At the apex of the angle, width of the track is increased 1.414 times, which leads to a mismatch of the characteristics of the transmission line distributed capacitance and especially the self-inductance of the track.

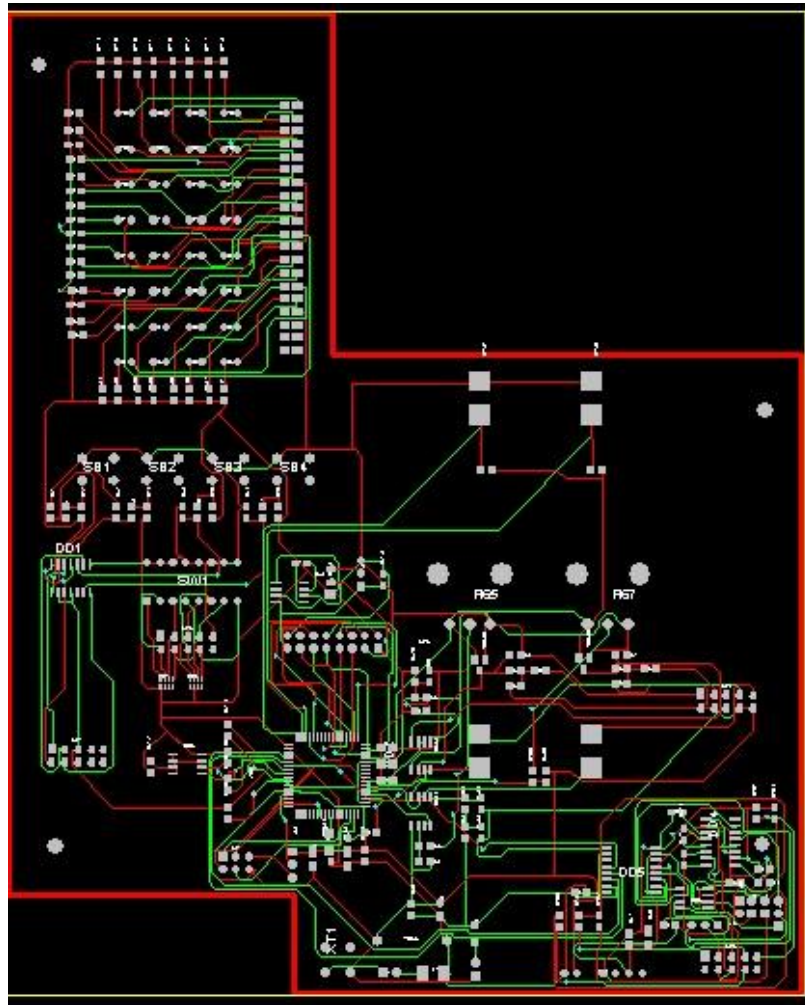

Figure 2 - automatic routing

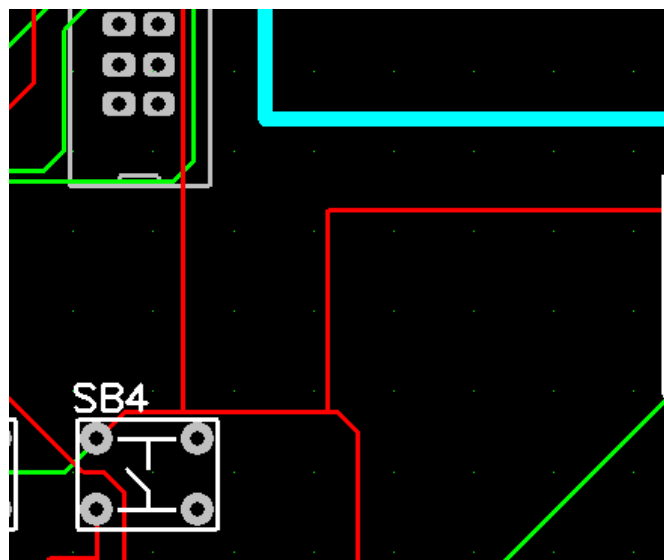

Figure 3 - shortcoming trace

Moreover, extended paths to the terminals on the power are required. If this is avoided, then due to the action of a common bus of large current a track can be burned and the device becomes unusable. As a rule, a common bus is usually placed to the power. Figure 4 shows a variant of the trace, here - it's a large training ground, occupying the largest area.

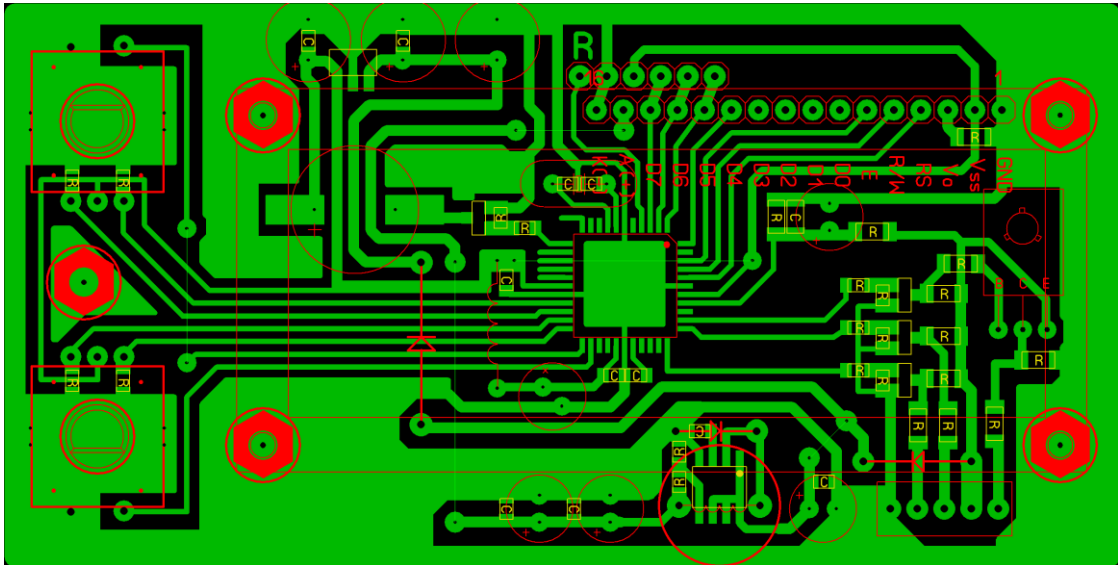

Figure 4 - common bus

It will be recalled that the estimated tire, which is typically a common wire may be disposed between the layers of the board. This arrangement is necessary when tracing schemes for devices operating at a high frequency to minimize the influence of the signals from different elements to each other.

If you use the manual method, it is possible to take into account all the shortcomings and do what is shown in Figure 5. The differences are more than noticeable.

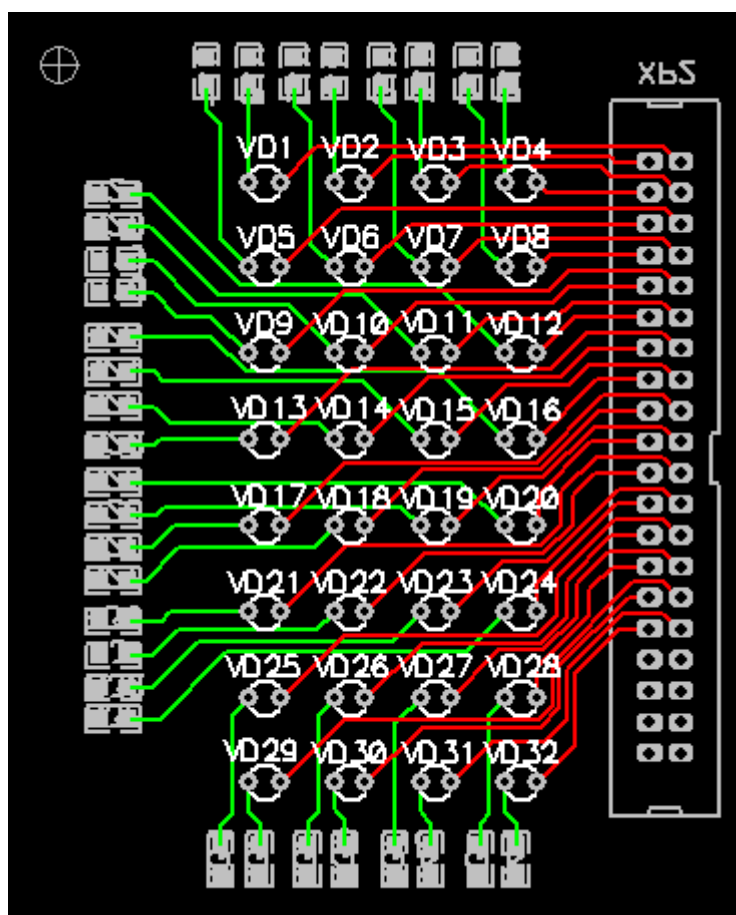

Figure 5 - manual tracing

Emulator signals - a relatively simple device, a printed circuit board which consists of only two layers, you can use manual routing, it does not take much time. However, if there is a development of more complex devices such as computer motherboard, then tracing the manual method is practically impossible. Then the most suitable is automatic routing.

References:

1. Bruce Carter. Machinery PCB layout.2005.
2. R. Linsker. An iterative-improvement penalty-function-driven wire routing system. 1984.
3. F. Rubin. An iterative technique for printed wire routing. 1974.
4. Tech PCB layout [Network resource]. – Access mode: <http://cxem.net/comp/comp40.php>

PRODUCTION OF SOLAR SILICON FOR MANUFACTURING PHOTOELECTRIC CONVERTERS AS A WAY TO INCREASE THE ECONOMIC POTENTIAL OF THE COUNTRY

D.S.Prakht, M. F. Dzhabbarova

Scientific Supervisor: Dr., Prof. V.A. Karelin

Linguistic Advisor: Teacher A.V.Tsepilova

Tomsk Polytechnic University, Russia, Tomsk, Lenin str., 30, 634050

E-mail: mariam93@mail.ru

***Abstract:** The paper describes the problems of producing and purifying of silicon for making photoelectric converters. Modern advances in silicon production for photoelectric transducers are also described.*

Introduction

In our time, the humanity needs more and more energy, the need for it is increasing every year. At the same time, reserves of traditional natural fuel (oil, coal, gas, etc.) are exhaustible. According to some researches by 2020 fossil fuel reserves will be able to satisfy the world's energy only partially. Stocks of nuclear fuel, namely uranium and thorium, are also exhaustible. Energy needs can be satisfied by renewable sources. Today, renewable energy sources are attracting more and more attention of both ordinary people and governments of many countries and international organizations. The major source of renewable is energy of the sun which can be obtained with the help of photovoltaic cells. This way of solving the energy problem is very attractive due to its cleanliness, using virtually inexhaustible source of energy and to the absence of long-term cycles of heating and rotating machinery. The main component of solar photoelectric converters is silicon, the production of which is a complex and expensive task.

The goal of our work is to identify the solar silicon production problems and possible solutions.

Photovoltaic power plants are our future

The most promising type of solar energy conversion into electricity are photovoltaic power plants with elements based on silicon, whose efficiency reaches 15%. However, such stations will be profitable only when there is technology and materials which can reduce energy costs 2 to 3 times. The main obstacle in this way is currently high cost of producing a polycrystalline silicon semiconductor with the aid of traditional methods.

Many countries are actively working on development of the production of solar energy converters, which are based on silicon "solar" quality as a material favorable for photoelectric converters with specific physico-chemical properties and with a high level of modern technology used for its production. But the development in this direction is constrained by the high cost of a unit energy produced by trichlorosilane method in comparison with conventional sources.

Silicon is the second most abundant element in the earth's crust. According to different information sources, silicon content in the earth's crust is 27,6-29,5%.

Benefits of Solar Panels

One of the advantages of using solar panels is that photovoltaic power plants are environmentally friendly and easy to build, thanks to their modular design. In addition, the photoelectric converters are characterized by high

reliability (at present they are the source of energy for virtually all satellites on the Earth's orbit because they work without breakdowns and require almost no maintenance), low operating costs (due to the absence of moving parts photoelectric converters do not require special care), environmental friendliness (fuel is not burnt when they work), modularity (owing to this property, photoelectric converters can achieve very different sizes, depending on the energy requirements), long life (up to 30 years), low construction costs (usually photoelectric converters are built close to the consumer, that is there is no need to pull the power lines over long distances or to buy transformers), and of course it should be noted that photoelectric converters are independent of changes in energy prices.

How polycrystalline semiconductor silicon is made

There are two main ways of making high (semiconductor) purity silicon. They are using trichlorosilane and silane.

When obtaining silicon from silane trichlorine

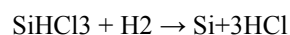

silicon tetrachloride and hydrogen chloride are formed, which leads to a decrease in silicon yield, penetration of harmful impurities, which are formed with the corrosion of chamber walls and other parts of the installation, into the silicon and causes environmental problems. Therefore, it is difficult to obtain ultrahigh purity silicon from trichlorosilane.

The use of monosilane technology has several advantages:

1. thermal decomposition of monosilane takes place at a relatively low temperature (about 850°C instead of 1100 °C for trichlorosilane) and lower energy consumption;
2. clearing monosilane from most harmful impurities *ceteris paribus* is more efficient because of the significant differences in physical and chemical properties of monosilane and other compounds;
3. together with the silicon there is a salable product which is itself a mixture of monosilane, which is needed for the thin film technology of manufacturing semiconductor products, including making solar cells of amorphous silicon.

However, this technology has certain disadvantages. So purification of monosilane by distillation at a low temperature requires cooling it with liquid nitrogen and helium, which greatly increases the cost of silicon. Furthermore, the known methods for producing monosilane are quite complicated in comparison with trichlorosilane, which is the cause of high cost of high purity monosilane in the semiconductor industry.

For this reason monosilane is used to a limited extent only for obtaining polycrystalline silicon of super high purity. Its reprocessing into single-crystal silicon is carried out by floating zone melting method.

To reduce the cost of monosilane and high purity silicon obtained from it an intensive search for new and effective ways is going on. Currently known methods include:

1. Method of Komatsu firm (Japan) provides atsedoliz magnesium silicide (Mg_2Si) from silicon metal and magnesium metal, its decomposition by ammonium chloride in liquid ammonia with the release of monosilane in the following reactions:

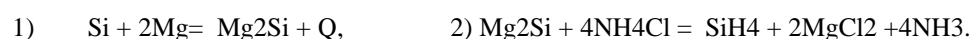

2. Disproportionation reaction is conducted with the purified trichlorosilane on the catalyst with obtaining thermally decomposed monosilane (Method firm Union Carbide USA) to polycrystalline silicon.

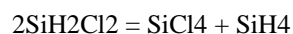

$\text{SiH}_4 = \text{Si} + 2\text{H}_2$ (decomposition occurs at $t=1050\text{ }^\circ\text{C}$)

3. The resulting purified trichlorosilane is thermally reduced with hydrogen (method of Siemens firm).

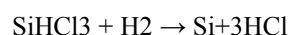

Methods of obtaining AUC from metallurgical silicon is technically complex and requires large investments and high operating costs for large commercial production. Production technology is not ecologically clean.

The problem of solar energy development

One of the main problems in the development of solar energy industry is creating new technologies for producing solar grade silicon, which would provide a drastic reduction in its cost due to the reduction of energy consumption, and making possible to obtain it in required amounts. In recent years the direction associated with the use of different methods of refining metallurgical silicon is being actively developed. The technology developed by the Institute of Geochemistry of SB RAS consists of three main parts: the carbothermic reduction of high-purity silicon from quartzite, a new technology of refining silicon melt, final purification of silicon from heavy elements and the formation of necessary columnar structure with directional solidification of polysilicon. The developed technology reduces the cost of electricity needed to produce 1 kg of polysilicon four times, and the cost of silicon becomes five times lower. Experimental samples polysilicon have already been obtained by the technology developed at the Institute. The basis of the technology is the use of high-purity natural quartz raw unique field super-quartzite Bural Sardag (Eastern Sayan) and pure carbon reductants, as well as a fundamentally new technology of silicon melt refining developed by the Institute.

The relevance of further study of silicon technology is undeniable. For example: In recent years there has been a steady increase in the output of solar modules (more than 30% annually), with a leading position (more than 85% of the market) belonging to photoelectric converters, which are based on mono- and multicrystalline silicon. In 2008 world production reached 5.6 GW of installed capacity exceeding 5 times the forecast made in 2001. In 2013, the production volume increased to 22 GW. The rapid growth of the production of photoelectric converters has led to a shortage of silicon solar grade. In 2008 about 50,000 tons of silicon was used. Thus high purity silicon in solar energy is able to reduce the deficit of electricity in the future.

Modern developments in production of photoelectric converters

The modern world has long been seeking to simplify and reduce the cost of production of photoelectric converters.

A new environmentally friendly fluoride method of producing polycrystalline semiconductor silicon from cheap natural quartz sand has recently been proposed. The method consists in the fluorination of dried natural quartz sand with elemental fluorine in a fiery reactor according to the following reaction:

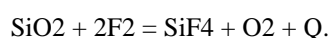

The impurity content in the resulting silicon tetrafluoride is not more than 2 ppm, including $\leq 0,06$ ppm of

phosphorus and $\leq 0,01$ ppm of boron.

A gaseous mixture consisting of silicon tetrafluoride and oxygen is fed into the electrolytic cell with a liquid cathode under a layer of melted eutectic fluoride salts. Silicon tetrafluoride with fluoride salts forms complex compounds according to the reaction:

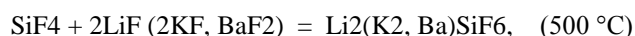

and oxygen does not react with the melted eutectic fluoride salt and together with volatile impurities is discharged into the atmosphere.

Complex fluoride salts formed in the reaction are electrolytically decomposed with appearance of elemental fluorine on the inert anode and of polycrystalline silicon on the cathode. During electrolysis impurities that are more electronegative than silicon do not lose their charge. Due to this silicon with such admixtures as boron, phosphorus, titanium, vanadium, chromium and other impurities can be obtained on the cathode.

At 500°C polycrystalline silicon fully dissolves in the melt of zinc (liquid cathode). The melt of silicon in zinc is recrystallized (if necessary, many times) by thermal vacuum distillation of zinc. As a result, silicon is very well additionally cleaned from impurities.

One of the latest innovations has been by ThermalTechnology company (USA). It has developed the process of making solar grade silicon from rice husk.

ThermalTechnology combined carbothermic reduction process with the biomass pyrolysis of rice husk into solar grade silicon. Pyrolysis provides an excellent mixture of SiO₂ and C, which is suitable for the recovery process, with a structure that facilitates purification to eliminate random elements. Using a combination of pyrolysis and carbothermal reduction it is possible to produce material of sufficient purity for use in the solar power industry.

Black silicon hypersensitive to light has also been developed in the USA.

A physicist from Harvard University, Eric Mazur has created a new material called "black silicon". The investor which supports research is the U.S. company SiOnyx, which invested \$ 11 million in the project.

During experiments on catalytic reactions on metal surfaces, the scientist changed the direction of research and sent a laser beam onto a silicon wafer. Etegas (sulfur hexafluoride) was used as the catalyst. The silicon obtained after treatment was black. The surface of the plate was covered with a variety of the subtlest particles.

In the study of the properties of the new material, it was found that black silicon has a very high sensitivity: 100-500 times higher than conventional silicon detectors. New material absorbs two times more visible light than conventional silicon and may perceive the infrared radiation which is not caught by modern silicon devices.

At present experiments aimed at studying the photovoltaic characteristics of black silicon are being conducted. SiOnyx is not going to produce their own solar panels using the new technology and will provide the technology for enterprises engaged in the solar energy industry.

Manufacturing of thin film solar cells, which comprise only about 1% of silicon in relation to the mass of the substrate, on which thin films are deposited, is also being developed. Due to the low consumption of materials thin-film silicon solar cells are cheaper to produce, but still have a lower efficiency and unrecoverable degradation of characteristics over time.

Conclusion

Photoelectric converters on silicon base have immense prospects of development because solar energy is one of new types of energy production, which is based on renewable resources. This kind of energy is inexhaustible, does not produce harmful waste. Moreover, it is environmentally friendly and can be considered as a potential energy resource, which is able to revolutionize the modern concept of energy supply and fully meet the needs of humanity.

References

1. AEnergy // Alternative energy– Retrieved march 18, 2014, from <http://aenergy.ru/2342>
2. AEnergy // Alternative energy– Retrieved march 18, 2014, from <http://aenergy.ru/775>
3. Jekotok // Environmental technology and alternative energy – Retrieved march 18, 2014, from http://www.ecotoc.ru/alternative_energy/solar_energy/d578/
4. Wikipedia, the free encyclopedia // Gazofaznaja jepitaksija – Retrieved march 18, 2014, from http://ru.wikipedia.org/wiki/%D0%93%D0%B0%D0%B7%D0%BE%D1%84%D0%B0%D0%B7%D0%BD%D0%B0%D1%8F_%D1%8D%D0%BF%D0%B8%D1%82%D0%B0%D0%BA%D1%81%D0%B8%D1%8F
5. Nemchinova N.V., Bel'skij S.S., Krasin B.A. High-purity metallurgical silicon as the basic element for solar power // Advances in current natural sciences. – 2006. – № 4 – Pp. 61-62
6. Fal'kevich Je. S., Pul'ner Je. O., Chervonyj I. F. et al. Semiconducting silicon technology.. – M.: Metallurgija, 1992.
7. Патент 2156220 RF, МКІ7 S 01 V 33/00, 31/36, 21/068. A way of obtaining metallic silicon solution, a way of obtaining metallic silicon from the solution and metallic silicon obtained using these methods. A way of obtaining ceramic materials and a ceramic material obtained using this method / A. I. Karelin, V. A. Karelin, D. A. Trubin, A. G. Chernyshev (Rossija). – № 99110318; Zajav. 26.05.99; Opubl. 20.09.00, Bjul. № 26; Priority 26.05.99.

ENERGY EFFICIENCY DEVELOPMENT

S. Seitkazi, K. Kuprin

Scientific Supervisor: S.N. Chegrincev

Linguistic Advisor: PhD, Associate professor T.G. Petrashova

Tomsk Polytechnic University, Russia, Tomsk, Lenin str., 30, 634050

E-mail: Seitkazynov_1995@mail.ru

Annotation

The focus of this article is energy efficiency development in the context of Russia. The purpose of the paper is to report on energy efficiency and to give an overview of energy efficiency development in Russia.

Key words: energy efficiency, renewable technologies, energy resources, «cutting-edge» technologies, national economy.

The scientists of United National Industrial Development Organizations (Africa) state that «Energy efficiency is understood to mean the utilization of energy in the most cost effective manner to carry out a manufacturing process or provide a service, whereby energy waste is minimized and the overall consumption of primary energy resources is reduced. In other words, energy efficient practices or systems will seek to use less energy while conducting any energy-dependent activity: at the same time, the corresponding (negative) environmental impacts of energy consumption are minimized.»

The impacts of energy use affect all of us and consequently, we should all be concerned about how to use energy more efficiently. However, the main bodies responsible for defining national approaches to energy efficiency are typically government agencies, whose responsibilities will usually include:

1. Enacting legislation which relate to energy efficiency if required, including defining an oversight role for energy regulators, when relevant.
2. Deciding the state budget for promoting and conducting energy efficiency activities and programmes for the general public, including tax or other incentives when appropriate.
3. Promoting energy awareness and disseminating useful information on energy efficiency measures and on recommended procedures for all sectors of the economy .
4. Allocating the budget and carrying out energy efficiency programmes in relation to government-owned assets, e.g. government buildings, vehicle fleets. These actions will serve as examples of good practices for others to follow.

Renewable energy technologies tend to have a higher profile than energy efficiency actions. This is mainly for the obvious reason that they are more visible as new installations and perceived as more «cutting-edge» technologies. This occurs even though they often have higher initial capital costs than energy efficiency measures (and may have less favorable operating costs too). However, one of the benefits of adopting renewables is the ensuing increase in awareness of energy production and consumption in the owner of the installation and also often with the public who can see or might interact with the technology. For example, solar PV or solar water heating panels on a public building raises the awareness of renewable energy use in the

building users and other members of the public [1].

This increased awareness of energy consumption may be used to stimulate awareness of energy efficiency by introducing energy efficiency measures simultaneously with a new renewable energy installation. As the renewable energy installation has a significant capital costs people can become more sensitive to the idea of «wasting» the energy from the system, especially if they feel a strong level of ownership of the renewable energy system.

In addition, a renewable energy system supplier/installer could make recommendations on how to use the energy produced in the most efficient manner, so output from the system could generate the most benefit in terms of services to the end-users. This is often a good opportunity to introduce demand-side energy savings measures.

From the supply-side perspective, a switch to renewables supports sustainable energy generation and contributes to reducing dependency on imported energy. For large scale operations, currently available renewable technologies are bio - mass-based cogeneration for electricity generation, on-shore and off-shore wind, geothermal energy and large-scale hydro. For small-scale side installations, the following types of technologies can offset the need for electricity or gas taken from a national grid:

1. Solar water heaters for water heating;
2. Small-scale wind generators and mini-hydro systems for electricity;
3. Solar PV for electricity;
4. Small-scale biomass technologies for heat and electricity.

Barriers to achieving a good level of energy efficiency improvement include the lack of policy or regulatory measures, the lack of information and awareness of potential benefits, a failure to emphasize good energy management, and a lack of technical capacity to identify, evaluate and implement energy efficiency measures. Technology and financing barriers are also seen in some situations. Of these barriers, the failure to practise good energy management is typically one of the most important factors for enterprises. Improving energy management is almost always a low-cost action that achieves valuable benefits in the short term. Maintaining good management ensures these benefits are continually contributing to enterprise profits (and the national economy) in the long term. [2]

Energy efficiency development in Russia

Alexander Gusev asserts that «Russian policy on energy efficiency has been moving slower than the EU had expected. The process is being slowed by the lack of coherent policies on the federal and regional levels as well as by an insufficient and ill-informed legal basis.»

The quality and timeliness of the necessary amendments will play a large role in the success or failure of policy on energy efficiency in the following years. Bilateral projects between Russia and EU countries mostly face problems such as an incomplete legal basis, administrative and technological issues, and difficulties in negotiations with municipal and regional authorities. However, due to public-private partnerships or project-financing mechanisms, it is possible to avoid or to diminish the impact of such problems. In this respect, namely Raiffeisen Bank has had successful experiences in working with regional authorities in Russia. The projects financed by the international (International Finance Corporation, European Bank for Reconstruction and

Development, Nordic Environment Finance Corporation) and European institutions (KfW) make a considerable and practical contribution toward increasing energy efficiency in Russia, mostly because they offer “cheaper money” with longer payoff periods; in addition, they are starting to offer special credit lines for households. Russian banks, on the contrary, underline that households may use consumer credits for energy-saving purposes. However, informational work on existing programs for companies and households should be carried out more actively by international and European organizations. For example, very few companies know about the programs supported by the German Federal Environment Ministry, such as ecological consultations, climate initiatives and an initiative on the export of renewable technologies and equipment.

Rising prices for electricity also increase the attractiveness and profitability of projects for foreign investors. At the same time, the increase in prices will force Russian companies and the general population to think about energy efficiency. Consequently, European solutions and know-how will be in great demand. In addition, the lack of generating capacities in Russia and increasing electricity consumption create excellent opportunities for investments in construction of combined heating/cooling plants and transformer substations. In terms of decentralized generation development, the Russian market presents excellent opportunities for the export of European technologies and solutions in the mid-term. At present, Russian banks and companies are interested in European experiences and know-how regarding decentralized generation, as well as cooperation with engineering companies and producers of related equipment. Collaboration on the construction and use of decentralized generation in distant areas should also be considered. Moreover, the development of decentralized generation in Russia would contribute to increases in energy efficiency as well as reductions in CO₂ emissions and gas flaring. [3]

In conclusion, Germany, France, Denmark, Finland, Italy and Norway are currently running projects on energy efficiency, electricity and renewable energy in Russia, such as:

1. Standards and Labels for Promoting Energy Efficiency in Russia
ongoing, Full-sized project: USD 7,810,000 (Global Environment Facility)
2. Transforming the Market for Efficient Lighting
ongoing, Full-sized project: USD 7,020,000 (Global Environment Facility)
3. Building energy efficiency in the North West of Russia
ongoing, Full-sized project: USD 5,840,000 (Global Environment Facility)

And others. [4]

Energy efficiency in Russia is increasing slower than in Euro United. But the Russian government understands that this problem is really serious, and plans to reach the level of the European Union in the energy efficiency development by implementing a lot of new programmes.

REFERENCES

1. [UNIDO] United National Industrial Development Organizations. Online book. Module 12. Energy efficiency technologies and benefits. Retrieved December 17, 2010, from < <http://africa-toolkit.reEEP.org/modules/>>.

2. Nathalie T., Isabel M. Development of Energy Efficiency Indicators in Russia. Retrieved January, 2011, from <<http://www.iea.org/publications/freepublications/publication/name,3946,en.html>>
3. Alexander Gusev, German Institute for International and Security Affairs, SWP Publication. Retrieved June 16, 2013, from <http://www.swp-berlin.org/en/publications/swp-comments-en/swp-aktuelle-details/article/eu_russia_energy_cooperation.html>.
4. [UNDP] United Nations Development Programme. Retrieved from <<http://www.undp.ru/index.php?iso=RU&lid=1&pid=305>>.

PROSPECTS OF THE USE OF FAST NEUTRON REACTORS

D.A. Serikov

Linguistic Advisor: O.P. Kabrysheva

Tomsk Polytechnic University, Russia, Tomsk, Lenin str., 30, 634050

E-mail: dmitrii_serikov@mail.ru

Abstract

The aim of this article is to consider fast-neutron reactors as a source of energy which is able to replace non-renewable natural resources that are the basis of the energetics and economic stability in Russia at the moment. The advantages of this type of reactors in comparison to the modern widely used thermal reactors are shown. The main problems of construction and functioning of fast-neutron reactors are mentioned.

Key words: fast neutron reactors, thermal neutron reactors, chain-reaction, non-renewable resources, uranium

Research field: energy production, nuclear power plants

Related science: nuclear engineering

Introduction

Nowadays, energy is one of the most valuable goods, so many countries use it actively. One of these countries is Russian Federation. The revenues from foreign economic activity of Russia in 2013 is about 38% of the income of the total Federal budget, ^[5] and fuel and energy goods is the greatest part of Russian export ^[4]. Obviously, Russia strongly depends on export of oil and gas resources, which are non-renewable. Besides, some part of these resources is spent on maintenance of the state needs. In the interview to the "Russian news service" the Minister of natural resources and ecology Yuri Trutnev said that the proved oil reserves of Russia would suffice for approximately 25 years, gas reserves - for 70 years. Nowadays there are two solutions of the problem: either Russia covers a lack of resources with import, or actively develops nuclear energy. At the moment nuclear energy does not exceed 20% of the total amount of the energy, produced in the country.

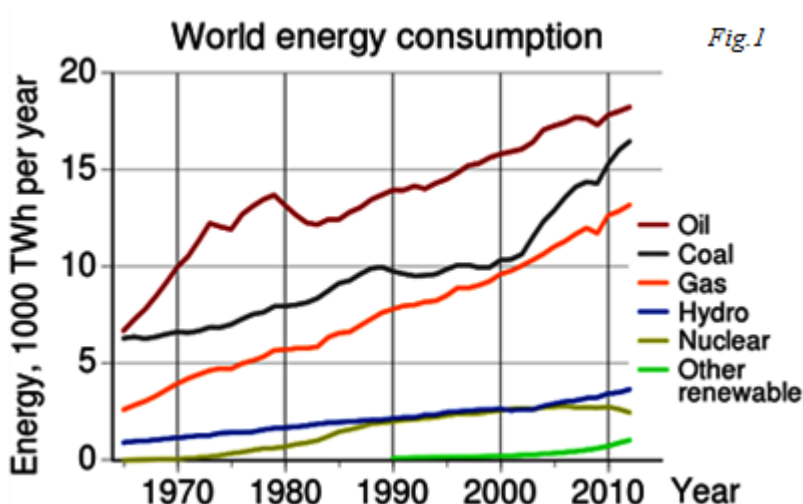

Fig.1

The graph of the ratio of energy sources to the world consumption (Fig. 1) shows that the energy from burning oil, gas and coal exceeds consumption of nuclear energy by times. It is evident that the consumption remains increasing.

All these facts and assumptions make Russia depend on the countries which export resources. So, the only solution is creation of its own energy base which is able to cover the needs of the whole country. At the moment the only real alternative is nuclear energy. However, taking into account the amount of

energy generation, current methods of processing of nuclear fuel have some strong disadvantages, such as spent nuclear fuel, radioactive waste, the disposal of which is still not developed, and the necessity of processing large amount of natural uranium to extract the necessary isotope uranium-235. The perfect solution in this situation is the construction of fast reactors, which will be discussed further.

Why fast neutron reactors?

It is known, due to collision of U-235 and neutron, U-235 releases some energy and emits on average 2.5 neutrons. Each of these neutrons causes the breakdown of another 2.5 nuclei launching the so-called chain reaction. The number of emitted decaying nuclei neutron must exceed the number of neutrons, leaving uranium conglomerate to keep the reaction stable. In this case, the reaction proceeds with the release of energy. The following graph presents the cross-section of interaction between nuclei U-235 and a neutron (Fig.2 2[6]).

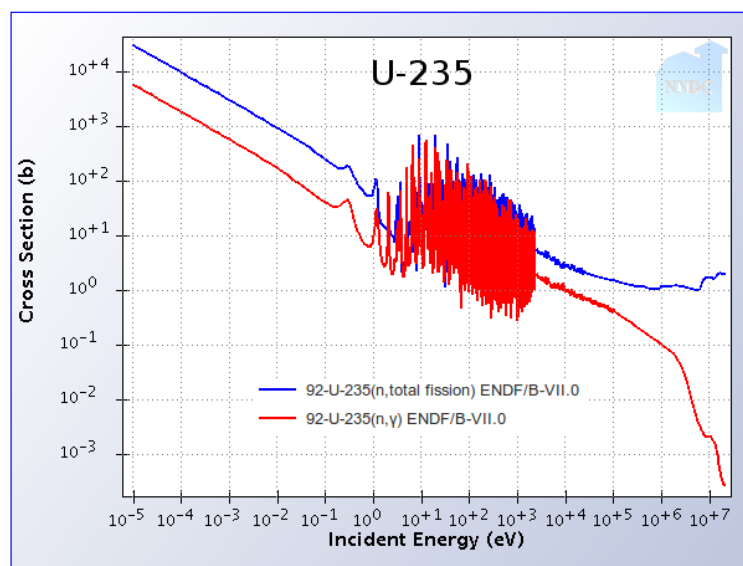
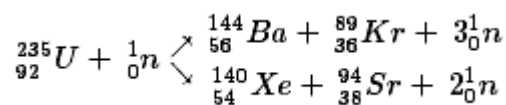

Fig.2

It is seen that the probability of interaction between nuclei U-235 and a neutron involved in the chain reaction grows with decreasing energy of neutrons. Actually, most of the neutrons released in the fission of uranium-235 nuclei have energy of about 1-2 MeV while the required energy of neutron for thermal reactor is less than 0.03 MeV. Therefore, water or graphite is used in thermal nuclear reactors to decrease the speed of neutrons to the same order as the speed of the thermal vibrations of atoms in the crystal lattice. As already mentioned, there is only 0.7% of the isotope nuclei U-235 in natural uranium, so, it is necessary to process tons of ore to obtain a few pounds of a suitable isotope. There are two possible options of fission of the atom nuclei U-235:



Spent nuclear fuel, opposed to fresh, has a significant radioactivity due to a large number of fission products and tends to self-heating in air to high temperatures, so after removal from the reactor core it is put in the cooling pool or at the periphery of the active zone of the reactor for 2-5 years. After reduction of the residual

energy release of fuel it is sent to the storage, disposal or recycling. Fig. 3 presents the cross-section of interaction between nuclei U-238 and a neutron (Fig.3[6]):

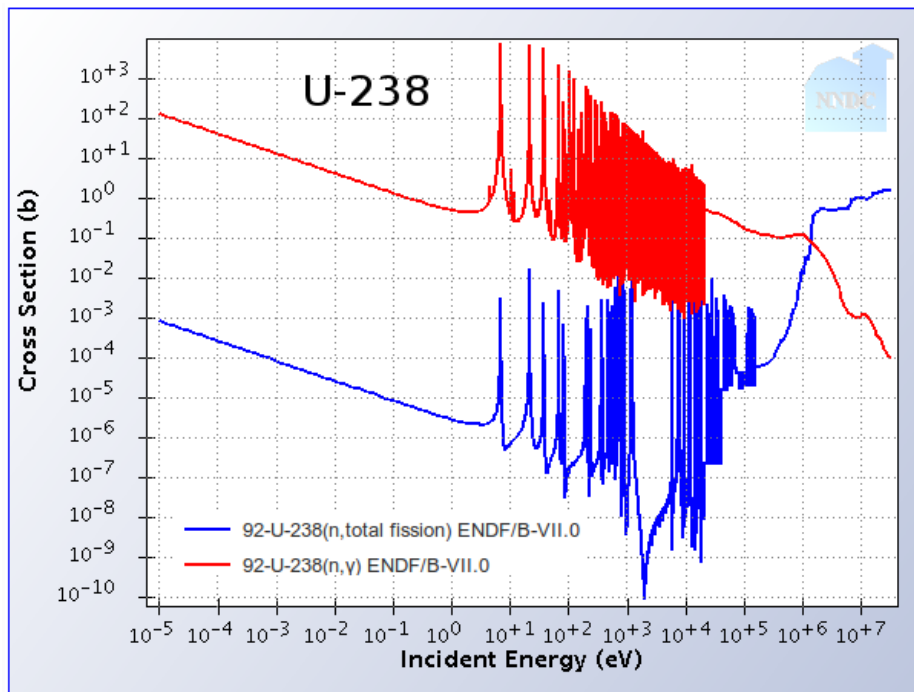
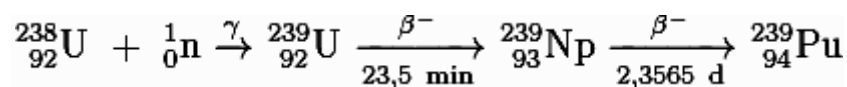

Fig.3

It is obvious, for large energies ($>10^5$ eV) the probability of interaction between neutrons and nuclei of uranium-238 increases when energy rises. However, the neutrons released in the reaction have on average entire energy of 1.25 MeV, which is not enough to start a self-sustaining reaction in uranium-238.

Let us consider the range of energy, at which the neutron can be captured by uranium-238 with the formation of uranium-239, which decays into plutonium-239 through beta-decays: This isotope has the same trend, so fast reactors can split and destroy this actinide as fuel rather than let them accumulate as in thermal reactors. The following reaction illustrates this process:



Another source of fuel is natural thorium:

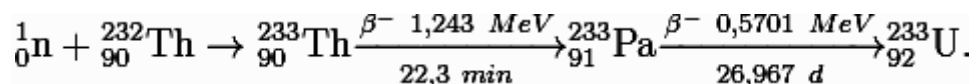

In the spontaneous fission of thorium uranium-233 is produced, which fission is very similar to uranium-235 fission. It is also released from the spent fuel in a chemical way.

As the cross-section of fission of fast neutrons is less than heat, the critical mass of substances in the reactor core should be higher (up to 20 % in fast reactors via 2-4% in thermal reactors). However, new fuel is produced in cassettes with thorium or natural uranium located around this core, so such big amount of substance is necessary only at the first step of operation.

In general, it is obvious that the design and construction of fast reactors is very expensive, but still remains cost-effective, as each neutron capture in the core of such a reactor leads to 1.5 times more neutrons of fission than in the core of reactor on thermal neutrons (Fig.4 [6]).

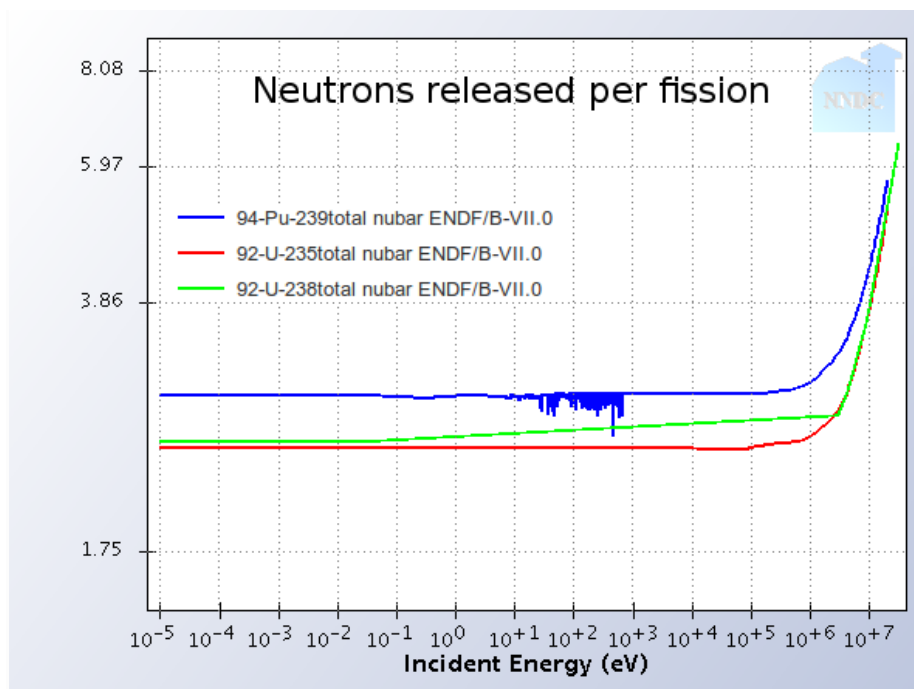

Fig.4

Therefore, for the processing of nuclear fuel in the fast neutron reactor far more neutrons can be used. It allows gaining a lot more fuel than it was originally produced (from uranium-238 and thorium).[1]

Selection of coolant

As cooling fast reactor with water or graphite is unacceptable, the question of selection of the new coolant appears. There are several options:

- Gases. Cooling with helium was considered, but due to its low heat capacity this gas is not suitable for cooling high-power reactors
- Mercury. For mercury testing the coolant reactor BR-2 with thermal power of 100 kW was built, but later the coolant was considered to be economically unprofitable.
- Molten salt. Reactors with this coolant work on different versions of fluorides of fissile materials (uranium, thorium, plutonium). In 1959 this training reactor was built in the Oak Ridge National Laboratory
- Liquid metal (lead-bismuth or lead) coolant. Some projects with this kind of coolant are currently being developed in Russia (Lead-bismuth fast reactor, Fast reactor with lead coolant, Angstrom - the project of a mobile ATPP, series of reactors for nuclear submarines)
- With sodium coolant. It is the most popular coolant for fast reactors around the world. Nowadays, the only operating fast neutron reactor is the bn-600 fast neutron sodium-cooled reactor. It was put into operation in April 1980 at the 3rd unit of Beloyarsk NPP in Sverdlovsk region near the town of Zarechny. Its electric capacity is 600 MW.

According to the Director of Rosatom, Sergey Kirienko, the construction of the reactor BREST-300 in Seversk, Tomsk region, is being prepared. This reactor will be used for the gradual development of all operating modes of fast neutron reactors with liquid metal coolant, after which the technology can be replicated in industrial scale.

Conclusion

The fast neutron reactors have clear benefits. Fuel for these reactors is sufficient for tens of thousands of years. The amount of spent nuclear fuel is incredibly small. In addition, the spent fuel of fast reactor reduces the radiotoxicity of the mined uranium much faster than a thermal reactors' one (150-200 years via 220 thousand years of Pressurized water reactors). Another advantage of fast nuclear reactors is processing U-238 instead of U-235 as there is only 0.7% of the U-235 in natural uranium. So it is necessary to process tons of ore to obtain a few pounds of a suitable isotope. Besides, related technical problems seem to be solvable, taking into account the future perspectives and the size of the problem in other branches being able to produce enough energy (for example, fusion).

From the economical point of view the cost of construction of such reactors is much higher than the cost of thermal reactors. However, it seems to be much more profitable and reasonable in the future. Thus, the extension of the existing data base of fast reactors, the accumulation of working experience, as well as the development of technology seem to be the most perspective course development of the Russian energy sector.

References

1. Левин В. Е. Ядерная физика и ядерные реакторы. 4-е изд. — М.: Атомиздат, 1979.
2. "Key World Energy Statistics" .International Energy Agency. 2006. Retrieved 3 April 2007. pp. 48–57
3. World Energy Assessment (WEA). UNDP, New York
4. <http://xn--b1ae2adf4f.xn--p1ai/analysis/10001-itogi-paboty-tamozhennyh-opganov-v-2013-godu-statistika-tamozhennyh-platezhey.html> «Итоги работы таможенных органов в 2013 году»
5. <http://info.minfin.ru/fbdohod.php> «Структура и динамика доходов»
6. http://www.whatisnuclear.com/articles/fast_reactor.html «Fast Reactors».

THERMONUCLEAR ENERGY IS A FUTURE SOURCE OF ENERGY

A.A. Sheveleva, E.V. Lemza, M.A. Doroshenko

Linguistic advisor: Senior teacher O.P. Kabrysheva

Tomsk Polytechnic University, Russia, Tomsk, Lenin str., 30, 634050

E-mail: maria.doroshenko.a@gmail.com

Annotation

With the development of nuclear physics, the problem of getting energy from nuclear fusion is topical nowadays. Despite all the difficulties in implementation, thermonuclear energy is a highly efficient source. Therefore, this kind of energy can become a base of economical potential of the country.

Key words: nuclear fusion, nuclear physics, energy, efficiency, sources, reactor.

Research field: nuclear physics.

Related science: nuclear chemistry.

Introduction

Energy production is the main problem of country's economy. There are several types of getting energy. Recent research in high energy plasma physics shows that nuclear fusion is the energy source that may provide the basis of a future sustainable energy system.

What is the thermonuclear energy?

Thermonuclear fusion is quite similar to most chemical reactions as two initial substances are combined together to create a number of new products. The energy released is called thermonuclear energy.

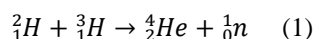

In thermonuclear fusion matter transforms into energy, according to mass defect which allows fusion to release energy. The mass of the initial reactants is greater than the mass of the final products and, as Einstein proved, the energy of material is proportional to the composition of the mass of the material and the square of the speed of light: $E = mc^2$ (2).

Whilst nuclear physics seems rather exotic and somewhat strange, actually it is as natural as photosynthesis in plants. Energy from fusion reactions is the basic form of energy in the universe. For example, nuclear fusion is the process which provides the existence of the stars. Our sun is a common example of natural nuclear fusion.

The main problem of realization of fusion is that the two reactants are both nuclei. It means that they are both positively charged bodies which are needed to join together. This presents a problem as similar charges repel each other. Only nuclei at extremely high temperatures have enough kinetic energy to overcome this potential barrier and so this is where the term thermonuclear fusion comes from.

Advantages and disadvantages of fusion

Thermonuclear fusion, as a major new source of energy, would have certain intrinsic advantages:

- the basic fuels (D, Li) are non-radioactive, plentifully available and fairly evenly distributed throughout the Earth's crust ;

- a runaway fusion reaction is intrinsically impossible. Furthermore, once its supply of fresh fuel is cut-off, the reactor can continue operating for only a few tens of seconds ;

- there are few radioactive waste problems: fusion generates no radioactive ash, and the unburnt gases are treated on site. Structural components of the reactor which have become radioactive through exposure to the neutrons will have been placed in storage - but, provided they are made of carefully-selected materials, the storage time could be less than one hundred years. [2]

Additionally, the choice of materials used in a fusion reactor is less constrained than in a fission design, where many materials are required for their specific neutron cross-sections. This allows a fusion reactor to be designed using materials that are selected specifically to be low active, materials that do not easily become radioactive. Vanadium, for example, would become much less radioactive than stainless steel. Carbon fiber materials are also low-active, as well as being strong and light, and are a promising area of study for laser-inertial reactors where a magnetic field is not required.

In general terms, fusion reactors would create far less radioactive material than a fission reactor, the material it would create is less damaging biologically, and the radioactivity "burns off" within a time period that is well within existing engineering capabilities for safe long-term waste storage.

Fusion power could easily satisfy the energy needs associated with continued economic growth, given the ready availability of fuels. There would be no danger of a runaway fusion reaction as this is intrinsically impossible and any malfunction would result in a rapid shutdown of the plant.

However, although fusion does not generate long-lived radioactive products and the unburned gases can be treated on site, there would be a short- to medium-term radioactive waste problem due to activation of the structural materials. Some component materials will become radioactive during the lifetime of a reactor, due to bombardment with high-energy neutrons, and will eventually become radioactive waste. The volume of such waste would be similar to the corresponding volumes from fission reactors. However, the long-term radiotoxicity of the fusion wastes would be considerably lower than that from actinides in used fission fuel.

There are also other concerns, principally regarding the possible release of tritium into the environment. It is radioactive and very difficult to contain since it can penetrate concrete, rubber and some grades of steel. As an isotope of hydrogen, it is easily incorporated into water, making the water itself weakly radioactive. With a half-life of about 12.3 years, the presence of tritium remains a threat to health for about 125 years after it is created, as a gas or in water. It can be inhaled, absorbed through the skin or ingested. Inhaled tritium spreads throughout the soft tissues and tritiated water mixes quickly with all the water in the body. Each fusion reactor could release significant quantities of tritium during operation through routine leaks, assuming the best containment systems. An accident could release even more. This is one reason why long-term hopes are for the deuterium-deuterium fusion process, dispensing with tritium.

While fusion power clearly has much to offer when the technology is eventually developed, the problems associated with it also need to be addressed if it is to become a widely used future energy source. [3]

Fusion reactor

Over the past 50 years, immense progress has been made in the fields of plasma science and fusion

technology. Still, harnessing fusion power and delivering it for industrial applications remains one of the greatest challenges of our time.

The problems of getting fuel for a fusion reactor are solved by the organization ITER (originally an acronym of International Thermonuclear Experimental Reactor). ITER is based on the 'tokamak' concept of magnetic confinement, in which the plasma is contained in a doughnut-shaped vacuum vessel. The fuel, a mixture of deuterium and tritium, two isotopes of hydrogen, is heated to temperatures in excess of 150 million°C, forming hot plasma. Strong magnetic fields are used to keep the plasma away from the walls; these are produced by superconducting coils surrounding the vessel, and by an electrical current driven through the plasma.

One of the tasks awaiting ITER is to explore fully the properties of super hot plasmas, the environment in which the fusion reaction will occur, and their behavior during the long pulses of fusion power which the ITER machine will enable.

Firstly, it is necessary to understand the course of the fuelling the fusion reaction. Although different isotopes of light elements can be paired to achieve fusion, the deuterium-tritium (D-T) reaction has been identified as the most efficient for fusion devices.

Deuterium can be distilled from all forms of water. It is a widely available, harmless, and virtually inexhaustible resource. Tritium is a fast-decaying radioelement of hydrogen. Tritium is produced when neutrons escaping the plasma interact with lithium contained in the blanket wall of the tokamak.

In fact, a fusion reaction is about four million times more energetic than a chemical reaction, such as coal, oil or gas burning. While a 1,000 MW coal-fired power plant requires 2.7 million tons of coal per year, a fusion plant of the kind envisioned for the second half of this century will only require 250 kilos of fuel per year, half of which is deuterium, the other half is tritium.[4]

Economical efficiency

This project is highly important for economical development of our country. The General Director of the International Organization ITER Professor Osamu Motojima emphasized the importance of this project:

«50% of the population of our planet lives on the territory of the countries, participating in the project, and these countries account for 80% of domestic product. The figures show how much the project is important not only for science, but also for the world economy. Now the mankind is on the threshold of a new era of fusion energy». [5]

We can also notice that the central role of energetics in our economic structure clearly shows itself for 10 years after the oil crisis. The nuclear energy is a reliable source for the nearest future, and the fusion energy is a huge potential for a more distant time. [6]

Physical protection

One of the principles in the field of nuclear energy is to ensure the safety of its use, the protection of individuals and populations, as well as the environment. Therefore, an examination of the alleged physical protection system of this nuclear facility is required.

In this paper the main criteria for a physical protection system (PPS) of a hypothetical power plant, based

on nuclear fusion is identified. The regulatory framework is considered with respect to realization of PPS for a nuclear facility. The aim of PPS according to the Order number 550 is to prevent unauthorized actions with respect to nuclear materials, nuclear facilities and other items PP on nuclear facilities [1].

Talking about thermonuclear facility, nuclear power plant (NPP) is meant as it has the structure analogous to PPS.

To create an effective physical protection system it is essential to identify the object of physical protection, analyse the consequences of unauthorized actions, and foresee possible targets of adversary.

Similarly to the objects of the physical protection of nuclear power, the objects of thermonuclear facility will be:

- 1) Power facility
- 2) Fuel

1. The aim of the adversaries is to incapacitate the hypothetical power station by means of sabotage. This can be done through the direct exposure or disfunction of the station, concentrating the magnetic field. All these might result in the station shutdown or an accident. Consequently, the PPS should provide sufficient protection barriers to prevent sabotage.

2. The fuels used in the fusion process, are tritium, deuterium and lithium. Tritium and deuterium are expensive elements that enhance attractiveness of these materials to the offender. Volume and mass of fuel needed to release energy are significantly less than it is needed for the object based on nuclear fission, which simplifies the theft of resources. Deuterium and tritium, with a special treatment, can be used as a resource for the development of a nuclear explosive device or radiological weapons. Therefore, the development of an effective system of control and accounting of nuclear materials is essential.

At the final stage there is no spent nuclear fuel, so additional monitoring is not required. In this way it differs from nuclear power stations. The major hazard may come from irradiated materials, because of powerful stream of neutrons produced by the reaction. However, the handling procedure of the irradiated materials for their further application is too complicated and expensive. Besides, there is the factor of self-protection of the material. Therefore, control of nuclear waste isn't required at the level which provides the security of spent fuel facilities operating on nuclear fission.

As it can be seen, there is need for an effective PPS, based on such factors as self-protection of waste, high cost of fuel, possible operating irregularity of the facility.

Conclusion

Thermonuclear fusion appears to be an ideal method of generating electricity for our growing needs. It is an environmentally friendly energy source, which produces no greenhouse gas. Besides, the materials for reaction are widely available. Thermonuclear fusion is controlled easier than nuclear fission, therefore it is safer. It produces no nuclear waste, which can be dangerous for hundreds of years and may be attractive to adversaries.

We all know that sources of our planet are not infinite and our generation should find a new effective way to produce energy. Perhaps, thermonuclear energy will become the one.

References:

1. Huges, P. (2005) “Thermonuclear fusion”
2. http://www.fusion-eur.org/fusion_cd/popu.htm
3. <http://www.world-nuclear.org/info/Current-and-Future-Generation/Nuclear-Fusion-Power/>
4. <https://www.iter.org>
5. <http://scientificrussia.ru/partners/sibirskoe-otdelenie-ran/kak-sobrat-termoyadernyj-reaktor>
6. <http://hizdis.ru/oblushenie/teplonos68.htm>
7. Tomsk Polytechnic university, (2009) Regional Training Course on Physical Protection of Research Reactors

**SYNTHESIS OF HIGH-PURE TITANIUM CONCENTRATES
BY THE ELECTROLYTIC METHOD FROM FLUORIDE MELTS**

E.V. Sorokina, K.O. Kovzel

Scientific Supervisor: Dr., Prof. V.A.Karelin

Linguistic Advisor: Senior teacher N.N. Zyablova

Tomsk Polytechnic University, Russia, Tomsk, Lenin str., 30, 634050

E-mail: sorokina_katya92@mail.ru

Kovzel_Ksenia_@sibmail.com

Annotation

The short review of industrial technologies of processing titanium concentrates is spent. Lacks of existing industrial production technologies of the titan are shown. Necessity of working out essentially new fluoride technologies of processing titanium concentrates is proved. The reactions proceeding at fluorination of a rutile concentrate by element fluorine are described, and thermodynamic research of fluorination process with use of the computer program "ASTRA" is executed. It is shown that from the thermodynamic point of view fluorination process has no restrictions. Dependence of change of mass concentration titanium fluoride in products of reaction from process temperature fluorination is investigated and the choice of optimum surplus of element fluorine is proved. The equilibrium structure of products of fluorination process a rutile concentrate is defined at the chosen surplus of fluorine. The basic stages of fluorination process are described and its kinetic features are studied. Factors influencing speed of fluorination process are defined. Temperature influence at kinetics fluorination process is investigated and optimum conditions are chosen. Mathematical processing of results of the executed kinetic researches on the equations is spent: Gistling, "reduced" sphere and Jander. It is shown that for the description fluorination kinetics it is necessary to use the Jander equation. It is established that process is limited by diffusive factors – a supply of a fluorinating reagent to a surface of a firm material. The size of energy of activation of fluorination process is defined. Conditions of carrying out of process in the industrial equipment are discussed.

Key words: *fluoride melt, electrolysing process, the fluorine, dioxide and tetrafluoride of titanium, fluorides of impurity, the electrolyzer, processes on the cathode and the anode.*

Titan possessing the row of valuable properties: high durability (attributed to the density of metal), excellent chemical firmness in relation to many aggressive environments and inhanceable hot – resistance, presently occupied leading positions on the use in different areas of modern science and technique.

For the last 60 years the great number of the new technologies directed to reduction of cost of titan produced Kroll – by a process is offered [1]. Nevertheless, offered technologies were not crowned by success, and researches on them were stopped in the period of economic crisis. Presently, the height of demand on titanium and high cost of his receipt resulted in a necessity to replace out – of – date Kroll – process with more effective technologies.

For the last 10 years for receipt of titanium concentrates a number of technologies is offered:

- PRP process (Great Britain) [2],
- FFC process (Cambrigian process) [3],
- MER process (Materials Electrochemical Research Corporation) [4].

These processes are based exceptionally on using TiO_2 as a feedstock. In the described methods there is no information about the cleanness of titanium and methods of its receipt.

All described methods possess the row of main defects of which are:

- A necessity of lixiviating of titanium concentrates from the initial cake,
- difficulties of transfer of calcium in to vapors and monitoring of the content of vapors of calcium,
- sharp reduction of output on current at the end of a process,
- electrolyte pollution by carbon due to dilution of the binding cathode in case of decay,
- a necessity of changeover of anodes because of their decay when electrolysing with separation of a gas compound of CO/CO₂.

We conducted researches on receiving high – pure metal concentrates of titanium by electrolytic edecay of tetrafluoride of titanium or hexafluorotitanate potassium (K_2TiF_6) in a eutectic compounds of fluoride salts of alkali metals [5]. For these purposes triple eutectic compounds of fluoride LiF – KF – NaF salts are probed and the composition 0,5M LiF eutectic – 0,39M KF – 0,11M NaF having a melting temperature of 472 °C and the greatest conductance in comparison with eutectics on the basis of chloride salts is recommended for practical use [6].

In case of absorption of tetrafluoride of titanium by a melt of a fluoride electrolyte response proceeds:

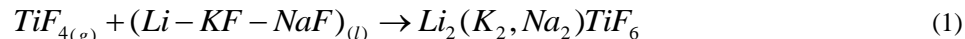

The level of saturation of a fluoride melt tetrafluoride of titanium makes up 3–3,5%.

After carrying out the process of saturation in a fluoride electrolyte the dissociation processes, being described responses proceed:

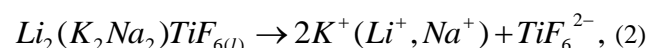

During carrying out of experimental researches on realization of process electrolytic there is formation of metallic titanium concentrates on cathode, and on an anode – element fluorine on reactions:

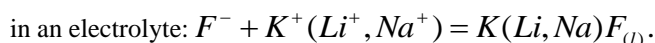
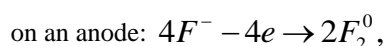
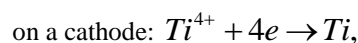

Researches conducted on the experimental electrolytic installation which diagram is given in figure 1.

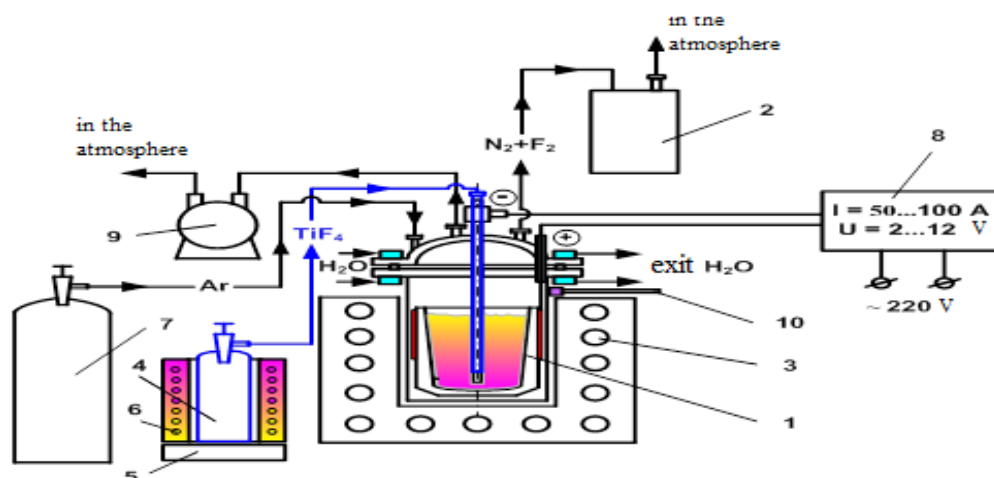

1 – electrolytic cell; 2 – absorber with an absorber (HP-I) for absorption of distinguished F_2 ; 3 – electrical furnace; 4 – capacity with TiF_4 ; 5 – PV-10 scales; 6 – the capacity electric furnace with TiF_4 ; 7 – bulb with inert gas (Ar); 8 – rectifier; 9 – vacuum pump; 10 – thermocouple.

Figure 1 – Installation diagram of electrolytic receiving metal concentrates of titanium.

The tetrafluoride of titanium which is in the capacity 4, heat in the electric furnace 6 to 300 °C. In case of this TiF_4 transfers from a solid status in gaseous, that is there is its sublimation. The expenditure TiF_4 in case of saturation of eutectic of fluoride salts is regulated by means of the valve of thin regulation set on the casing of a bulb. Measuring bulb mass by means of PV-10 scales with a margin error weighings ± 5 g the amount of tetrafluoride of titanium given to a melt is regulated.

The general view of installation of electrolysis and separate nodes are provided in figure 2.

The initial fluoride salts have very high temperatures of melt: $T_{melting} LiF = 870$ °C, $T_{melting} KF = 857$ °C, $T_{melting} NaF = 992$ °C therefore for receiving fluoride eutectic potassium hydrofluoride ($KF \cdot HF$, $T_{melting} KF \cdot HF$ of = 239 °C) in a compound with lithium and sodium fluorides is used. In case of heating up of such compound there is $KF \cdot HF$ decay with formation of $LiF \cdot HF$ and $NaF \cdot HF$ having melting temperature, not exceeding 300°C. Such compound at first passes into the melted status, and then, in case of increase in temperature to 472 °C, there is an decay of hydrofluorides of all alkali metals with formation of fluoride eutectic of $LiF-KF-NaF$ composition. Being selected waterless HF is caught by on HP-I absorber.

Eutectic of fluoride salts are prepared proceeding from their ratio:



$$12,97g \quad 22,659gKF \quad 4,62g$$

$$30,459gKF \cdot HF \quad \Sigma = 48,05g$$

$$\left(\frac{12,97}{48,05}\right) \cdot 100 = 26,99\%mas. - \left(\frac{30,459}{48,05}\right) \cdot 100 = 63,39\%mas. - \left(\frac{4,62}{48,08}\right) \cdot 100 = 9,62\%mas.$$



a) b)



c)

d)

a) general view of installation; b) hermetic electrolytic cell; c) the nickelized cover of the electrolytic cell; d) the graphite crucible – anode current conductors to the anode (below), The metallic cathode (above) and an electrolytic cell retort (at the left).

Figure 2- Experimental electrolytic installation of electrolytic expansion of tetrafluoride of titanium.

The received fluoride eutectic sated with tetrafluoride of titanium to concentration of 7,75% or 3% in terms of Ti. In case of saturation of a fluoride melt complex salts will be formed in case of 500 °C.

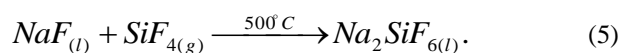
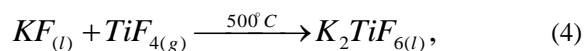

Fluorotitanat of lithium will not be formed since they are unstable in case of 500 °C.

The melt of an electrolyte consists from:

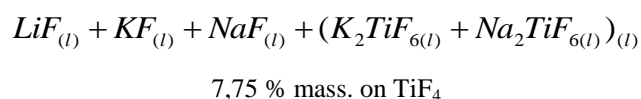

In fusion of electrolyte the processes of dissociation flow:

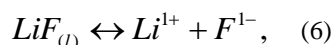

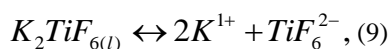
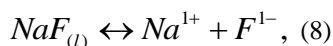
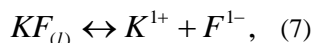

For the saturation of the fluoride eutecticum of tetrafluoride titan got through the central carbine of lid of muffle (figure 1) insert the metallic union coupling of working gas (TiF₄) to support in the bottom of graphite crucible. Then the metallic union coupling of working gas is lifted upwards on 3 cm and in this position nick in relation to flange of lid is made on it. The stuffing-boxes of the union are made more coupling and lid. The union coupling of working gas is hermetically connected by a metallic tube with an absorber 2 and by a capacity 4. an Absorber-absorber is filled with a marble crumb or chem. HPI absorber.

Cooling of a cover of a muffle with water is included, then a furnace 3 electrical heating is included, temperature in a metal muffle is increased, controlling temperature according to thermocouple 10 indications and gradually increasing it to 500 °C. At a temperature of muffle of 450–500 °C an eutectic melt is sated with tetrafluoride of titanium. For this purpose in beforehand heated to 300 °C capacities 4 a valve of thin regulation is opened and TiF₄ submission in a melt is regulated on a decrease of mass of capacity 4.

After saturation of melt by tetrafluoride of titanium a valve of thin regulation is closed. A metal branch pipe with the rod cathode is replaced, having weakened a glandsealing beforehand.

The electrolyzer has the following technical characteristics:

- productivity is up to 50 g/hour on tetrafluoride of titanium;
- the volume of a muffle is 1,35 dm³;
- force of a direct current is up to 100 A;
- supply voltage of working electrodes 2...12 V;
- temperature of an electrolyte 50...550 °C;
- working surface of the anode 0,0587 of m²;
- working surface of the cathode 0,0118 of m²;
- current density: anode 0,085...0,13 A/cm²;
- the cathode 0,42...0,63 A/cm².

For carrying out the process of electrolysing on the graphite cathode (rod) and the anode (crucible) give the direct current which value varies within 50...100 A, and tension – within 2...12 Century. During electrolysing process on the graphite cathode there is a formation of a precipitate (powder of titanium in a melt of fluoride salts), and on the anode – the element fluorine which brings out the electrolyzer and is absorbed in an absorber – 2 on a chemical absorber lime HP-I (a compound of 96% of Ca(OH)₂ and 4 of % of NaOH).

After the end of process of electrolysing the cathode with the selected precipitate consisting of powder of titanium in a melt of fluoride salts, is lifted over an electrolyte melt, the electrolyzer is cooled and before its depressurization is blown with inert gas (argon) from a bulb – 7.

Appearance of the cathode with the formed precipitate is shown in figure 3.



a) the metallic cathode with the powder of titanium received on it in a compound with an electrolyte; b) the powdery titanium removed from the cathode in a compound with an electrolyte

Figure 3 – Appearance of the cathode after electrolysis and the cathode precipitate removed from it

The formed precipitate is ground mechanically and washed from fluoride salts waterless HF solution – 20 °C. Thus Li, K and Na fluorides are well dissolved in HF. Their solubility in case of – 20 °C makes respectively 9,3; 9,1 and 19,2% Mas. Titanic powder in these conditions remains in a solid status.

Final scrub is carried out in acetone and ethyl alcohol.

In figure 4 influence of the cathode current density (I_k) on an output of titanium on current (η_T , %) in the cathode product is shown. It is visible that in case of current density higher than 0,4 A/cm² the output of titanium on current intensity exceeds 90% and in case of increase in current density practically doesn't change.

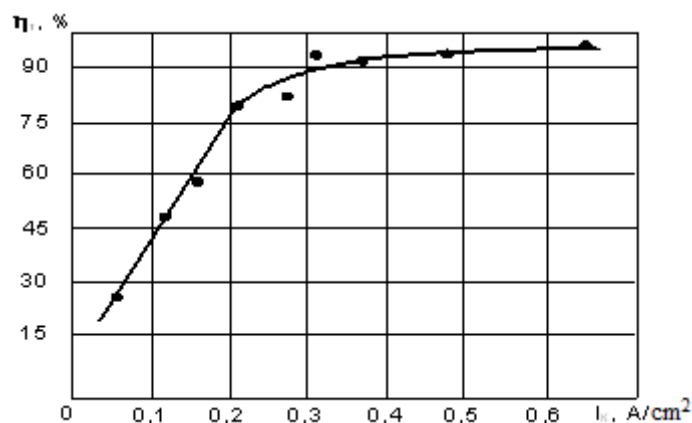

Figure 4 – Influence of the cathode current density (I_k) on an output of titanium on current (η_T , %)

The content of titanium in the cathode product when electrolysis TiF_4 in a fluoride salt melt makes 35–40% Mass output Ti of on current made $\eta_c \sim 90$ –95%.

The experimental results on electrolysis of titanium are provided to tabel 1 in a fluoride electrolyte of $LiF-KF-NaF-TiF_4$.

Table 1 – The experimental results on electrolysing of titanium in a fluoride electrolyte

n/n	Mass of the initial electrolyte,g	It is processed,g		Ti is received,g	η_r , %
		TiF ₄	Ti whith TiF ₄		
	1250	100	38,7	38,1	98,5
	1875	150	58,1	56,2	96,7
	1250	100	38,7	38,1	98,5
	1875	150	58,1	66,2	96,7
	1625	130	50,3	47,0	93,4
	1250	100	38,7	38,1	98,5

Electrolysing conditions:

- composition of an electrolyte, % Mas. : (29,98) – KF(52,17) LiF – NaF(10,66) – TiF₄ (7,19);
- parameters: $I_a = 0,09 \dots 0,13 \text{ And/cm}^2$, $t = 500 \dots 550 \text{ }^\circ\text{C}$, $\tau = 6 \text{ h}$.

Analysis results of powder of the titanium received as a result of electrolysing of TiF₄ in eutectic of fluoride salts (LiF–KF–NaF) are provided to tabale 2.

Table 2 – Chemical composition of electrolytic titanium concentrates.

Element	Contents, % Mas.
Ti	basis
Ni	0,17
Cu	$6 \cdot 10^{-2}$
Mg	$3 \cdot 10^{-2}$
Fe	$2,4 \cdot 10^{-2}$
Nb	$1,2 \cdot 10^{-2}$
W	$< 1 \cdot 10^{-2}$
Zn	$9 \cdot 10^{-3}$
Cr	$3 \cdot 10^{-3}$
Mo	$2 \cdot 10^{-3}$
Co	$1 \cdot 10^{-3}$
Sn	$1 \cdot 10^{-3}$
Mn	$< 1 \cdot 10^{-4}$
Ca, Si	$< 5 \cdot 10^{-3}$
Al, Mg, Pb, Zr	$1 \cdot 10^{-3}$

When carrying out researches it is set that processes of a hardfacing of fluoride eutectic, its saturation by tetrafluoride of titanium, electrolytic restoration proceed stably in strict accordance with the regulated (in advance set) norms. Due to the moisture hit from air because of its suction through glandsealings of electrodes, and also as a result of overheating of walls and a cover of a retort of the electrolyzer for support of a temperature mode of a melt of an electrolyte education and hit in an electrolyte of products of corrosion and pollution of electrolytic powder of titanium by them was watched. For an exception of formation of such pollution a cover

and all details of the electrolyzer from the stainless steel, being over an electrolyte melt, were stimulated to cover with a thin film of electrolytic nickel.

When carrying out researches it is set that the precipitate of powder of titanium with an electrolyte when cooling cathode to indoor temperature is very strongly fastened to its basis.

So, when using cathode from graphite, it is almost impossible to remove a precipitate from its surface. From other tested cathode materials of settlings cathode precipitate was he moved only when cooling cathode in liquid nitrogen. Thus together with the cathode precipitate from the cathode the film 1–2 mm thick seen approximately from a cathode material was deleted. When grinding a precipitate and its scrub there was a mechanical pollution of electrolytic powder of silicon by metal impurity. Such pollution of powder of silicon by metal impurity managed to be excluded when using cathode from titanium.

Thus, when carrying out process of electrolytic receiving titanic powder:

– it is set that in case of TiF_4 dilution in fluoride eutectic of salts of $LiF-KF-NaF$ alkali metals complex salt – $Li_2(K_2, Na_2)$ by TiF_6 is dissolved well in a fluoride and melt will be formed;

– when electrolysing $Li_2(K_2, Na_2) TiF_6$ the powder of titanium which is in a compound with fluoride eutectic will be formed on the titanic cathode;

– under optimum conditions of carrying out electrolysing of tetrafluoride of titanium in a fluoride salt melt the output of titanium on substance in the cathode product reaches 93,4 – 98,5% Mas. that is much higher, than in case of magniyetermichesky restoration of tetrachloride of titanium when carrying out Kroll-process;

– the content of impurity in powder of titanium after washing from fluoride eutectic does not exceed 0,1% that is much less, than in titanic powder of the TG–Tv brands, etc.

REFERENCES

- 1 . Rare and scattered elements. Chemistry and technology. In 3 books. The textbook for HIGHER EDUCATION INSTITUTIONS Korovin S. S., Zimina G. V., Reznik A.M. etc. / Under the editorship of S. S. Korovin. – M, MISIS, 1996.
2. www.okabe.iis.u-tokyo.ac.jp/japanese/for_students/parts/pdf/060312_TMS_SanAntonio_Presen_Zheng.pdf
- 3 . www.unsworks.unsw.edu.au/fapi/datastream/unsworks:7204/SOURCE02
- 4 . www.francoiscardarelli.ca/PDF_Files/Article_Cardarelli_MER_Process.pdf
- 5 . Karelin V.A. Karelin A.I. fluoride technology of processing of concentrates of rare metals: Monograph / Otv. Edition of V.A. Matyukh. – Tomsk: NTL publishing house, 2002. – 184 pages.
- 6 . Karelin V.A. Petrakova O. G., Kovalyov S. V. Fluoride technology of processing molibdenitovykh of concentrates//Sb."Technology and automation of nuclear power". – Seversk, 2003. – Page 29-32.

ALKALINE AND ALKALINE-EARTH METALS FLUOROHALOGENATES IN ORGANIC SYNTHESIS

V.D. Suprunenko, V.I.Sobolev

Scientific Supervisor: PhD, Associate Professor R.V. Ostvald

Language Advisor: Senior teacher U.A. Smirnova

Tomsk Polytechnic University, Russia, Tomsk, Lenin str., 30, 634050

E-mail: vladislav94ru@mail.ru

In recent years, threefluoridebromin is famous fluorinating and bromating agent in chemistry of organic compounds. The main feature of threefluoridebromin is its feature of electrophilic bromating high-deactivated aromatic compounds. It is known that nitrobenzene forms 3-bromo-nitro benzene with good output. However, threefluoridebromin is a dangerous compound. In this way, using alkaline and alkaline-earth metals fluorohalogenates in organic synthesis is safer.

Tetrafluorobromates are white loose crystal substances, which have low reactivity. Degrading, they form threefluoridebromine which has low decomposition temperature, and possess good fluorinating, and bromating agents. Today chair CTRE is a study on the methods of synthesis tetrafluorobromates and their properties and application. (expand)

Equipment.

Spectrums of gas chromatography-mass-spectrometry (GX-MS) of the interaction products were measured with the help of chromatomass-spectrometers TRACE DSQ on the base of TPU Scientific and Analytical Center. The analysis was performed with the following parameters: expansion coil temperature – 280 °C; thermostatic oven temperature +40 °C - +300 °C; heating speed – 10 °C/min; range of mass scanning – 33-350 a.u.m.

Initial substances

- Kalium tetrafluobromate, KBrF_4
- Barium Tetrafluobromate, $\text{Ba}(\text{BrF}_4)_2$.
- *p*- Nitrobenzene diazonium tosylate
- Nitrobenzene
- Distilled water
- Calcium chloride, $\text{C}=0,7\text{g/ml}$. solution was prepared immediately before the experiment.
- Siliceous gel, Sigma-Aldrich Silica gel orange, $\geq 99\%$, 10087-2.5KG-R.
- Sodium fluoride, Sigma-Aldrich Sodium fluoride, $\geq 98\%$, 71522-500G.

Interaction of KBrF_4 and NBDT in solid state was conducted at following molar ratio of reactants: 3:1; 1:1 and also 3:1:1 in the presence of one mole NaF as an inert diluents. The following reagent samples were used: KBrF_4 - 183 mg (61 mg for a molar ratio 1:1); $\text{Ba}(\text{BrF}_4)_2$ - 420 mg (140 mg a molar ratio 1:1) *p*-nitrobenzenediazonium tosylate - 100 mg; NaF - 13 mg.

- General experimental techniques for solid substrates are:

- 1. Material samples are placed in an agate mortar and triturated gradually at room temperature in the given proportions.
- 2. This technical product is poured with distilled water and vigorously stirred until complete dispersion in water.
- 3. A concentrated solution of CaCl_2 ($C = 0,7 \text{ g} \setminus \text{ml}$) is added into this slurry to precipitate the free F-ions as an insoluble precipitate of CaF_2 .
- 4. 5ml of ethyl acetate is added into this mixture for extraction of organic substrates into organic phase.
- 5. The aqueous and organic phases are separated using a separatory funnel.
- 6. The organic phase is purified by resinous impurities by filtration through silicagel.

Interaction of KBrF_4 and NBDT . In a 3:1 molar ratio active instantaneous emission of gaseous products is observed as white smoke formation and heating of brown oily substance mixture. The chromatogram of the products of interaction and one of the mass spectra of obtained substances is presented in Figure 2.

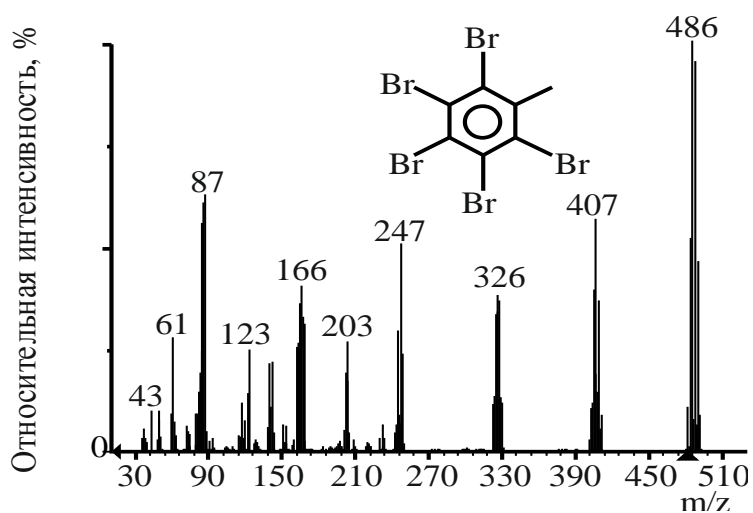

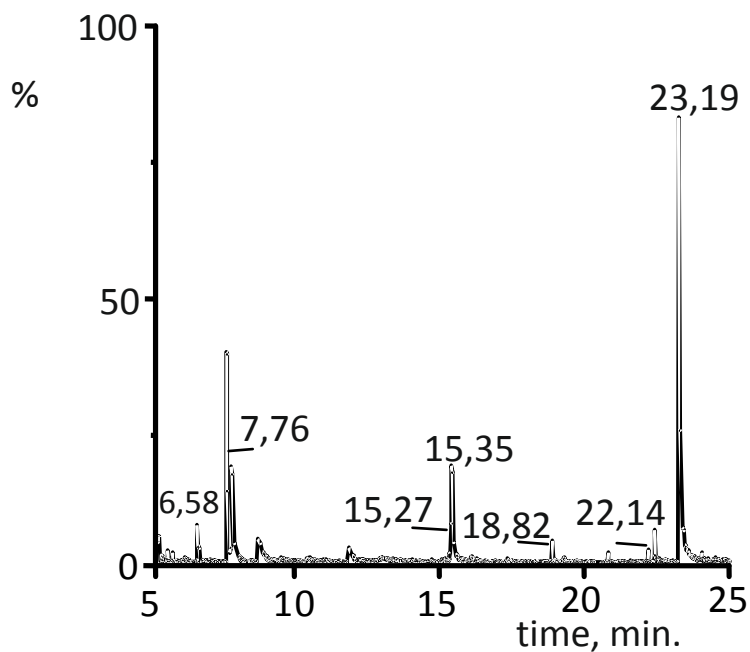

Findings

Kalium and barium tetrafluorobromates show high reactivity feature in organic substances in the form of aromatic diazonium salts. Degradation reactions of the diazonium salts to form nucleophilic substitution and electrophilic bromination is predominant over the interaction of reactants. This reaction dominates with nitrobenzene, consequently kalium and barium tetrafluorobromate and threefluoridebromine react equally.

REFERENCES

1. Diachkova T.P. *Khimicheskaia tekhnologia organicheskikh veshstv.* – 2007. – С. 37-44.
2. Orlov G.D., Saraev V.A. *Razrabotka Tehnologii, proizvodstvo i primenenie bromhladonov // Soedinenie ftora.* – Sant-Petesberg: Teza. – 2009. – С. 41-44.
3. *Maksimov B.N, Barabanov V.G. Promishlennii ftor organicheskie produkti //Sprav. izd.* – : Himiia. – 1990. – С. 221.
4. Plate N.A. *Osnovi himii I tehnologii monomerov.* – : Nauka. – 2002. – С. 199-210.

RESEARCH OF ION EXCHANGE RESINS CAPACITY IN EXTERNAL CONSTANT MAGNETIC FIELD

N.V. Tundeshev

Scientific Supervisor: Prof., Dr. V.F. Myshkin

Language Advisor: Teacher A.V Tsepilova

Tomsk Polytechnic University, Russia, Tomsk, Lenin str., 30, 634050

E-mail: Tundeshev93@mail.ru

Annotation

This article shows that the external magnetic field affects the saturation time of ion exchange resins in water sorption of lithium sulfate. The data on the resin saturation time of the salt concentration in a constant magnetic field and without the field are obtained. There is also a model explaining the experimental data.

Ion exchange techniques are widely used for obtaining fresh water from solutions such as seawater. The increasing demands for fresh water require the development of innovative techniques of water purification from dissolved salts. One of the factors that can change the balance in the system ion exchanger. - the solution is the magnetic field.

Magnetic treatment prevents precipitation of scale-forming salts from the water on the inner surface of tubes and significantly reduces the deposition of organic substances such as paraffins. [1].

Effect of the magnetic field on the water is complex and associated with changes in the structure of water, hydrated ions, physical and chemical properties and behavior of dissolved inorganic salts [2, 3]. In a magnetic field rates of chemical reactions change due to the competing processes of dissolution and precipitation of dissolved salts, the formation (decay) of colloidal systems in water. [4]

The goal of this work is studying the influence of magnetic field on the saturation time of ion exchange resins in water solution of lithium sulfate.

The principal flow sheet of the ion-exchange column for experimental studies of the influence of the magnetic field on the time of its protective effect is shown in Fig. 1. For the formation of ion-exchange columns a vertically installed glass tube with an inner diameter of 1.5 cm and a length of 77 cm is used. The lower end of the tube is filled with plastic granules and the diameter of tube is decreased to 3 mm. The top of the inert filler is covered with granular exchange resin KU-2. The amount of ion exchange resin in all the measurements was 7 grams.

Permanent magnets remanence 1.2 T and dimensions 3×5×1 cm are installed around ion exchange resin.

In the experiments, the lithium sulphate was diluted in distilled water and poured into the ion exchange column. Water seeped through the resin filler fell into a receiver of demineralized water in the form of droplet. Periodically drops are selected on a copper plate. The presence of lithium ions in the sample was determined by the appearance of the crimson glow of the solution on the plate in the flame of a spirit lamp. The time of appearance of the output columns of lithium ions without magnetic field and with established magnets is determined. Flow rate of the solution through the column is 17 ml / min.

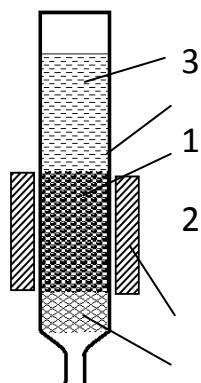

Fig. 1. Scheme of the ion exchange column. 1 – the tube, 2 – ion exchange resin, 3 – water solution, 4 – permanent magnet, 5 – inner filler

Table 1 shows the times of onset of lithium ions at the outlet from the exchange column (resin saturation time) without the field and with the magnetic field. It can be seen that with increasing concentrations of lithium sulphate the influence of an external magnetic field is greatly reduced.

Table 1. Dependence of Li_2SO_4 solution concentration on resin saturation time without the field and with the magnetic field

[Li_2SO_4], %	1	1,95	2,5	3	3,48	4
t_0 , s	1655	1434	1338	825	796	769
t_m , s	1887	1634	1523	910	886	845
δt	0,1402	0,1395	0,1383	0,103	0,1131	0,0988

With the help of this table we can see that resin saturation time is increased in the magnetic field.

The relative magnitude of the magnetic field at the time of the protective action of the resin is determined by the formula

$$\delta t = \frac{t_m - t_0}{t_0},$$

where t_m , t_0 are protective action of the resin in a magnetic field and without it respectively.

For understanding of experimental results let us consider the structure of resin KU-2 which is shown in figure 2. Every monomer of resin includes 6 ions of Na^+ , which can be replaced by ions of water solution.[5]

Using the program HyperChem 8.0.8 the following parameters of resin are calculated: oscillation frequencies of different atoms and ions in the monomer, the amplitude of thermal fluctuations, the excess charge distribution of selected atoms. The most mobile ions Na^+ (marked in Fig. 2) have the most intensive oscillation frequency with wave number 220.26 cm^{-1} ($f = 6,7 * 10^{13} \text{ Hz}$, $T = 1.49 * 10^{-13} \text{ seconds}$). The amplitude of the oscillation is $A = 9,5 \text{ \AA}$.

In monomer of resin KU-2 ions of active groups oscillate with certain frequency and amplitude because of thermal motion. Also all ions of active groups have effective square of exchanging $\sigma_{\text{эфф}}$ which is perpendicular to the direction of electromigration in which ion exchanging is possible.

Because of a slower speed of electromigration relative to the speed of vibrational motion exchanged ions repeatedly collide in the same point.

In the magnetic field Lorentz force influences the motion of atoms with excess charge. For selected ions Na^+ (in Fig. 2 from left to right) the excess charge calculated with HyperChem 8.0.8, is 0,559e and 0,618e respectively. The velocity of the ions in oscillatory motion has sinusoidal character: the maximum in the equilibrium position, the minimum on peripheral points. For this reason at any distance trajectory of ions Na^+ is an arc with varying curvature and every next arc moves from the previous one within a certain circle, determined by the amplitude of the thermal vibrations that can be seen in figure 3.

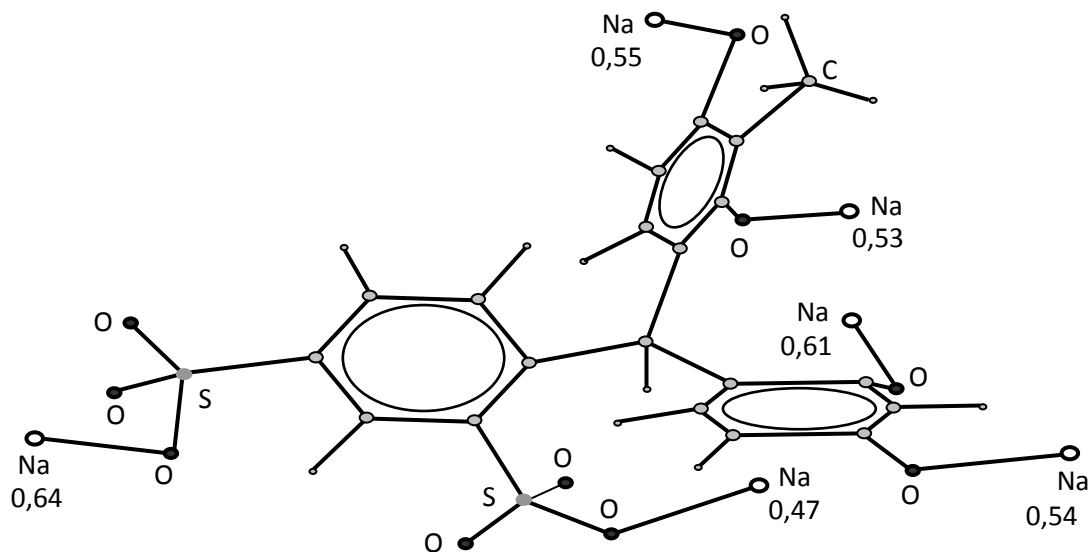

Fig. 2. Graphical structure of exchanging resin monomer KU-2

After a number of oscillations position of the arc path in space repeats because the sodium ion has consistently bypassed the point of the circle described by the ion trajectory without a magnetic field.

Because of increasing of effective interaction square and low speed of ion motion in solution the probability of exchanging is increased.

Effective square of ion exchanging in magnetic field is changed to $\sigma_{\text{эфф}}$.

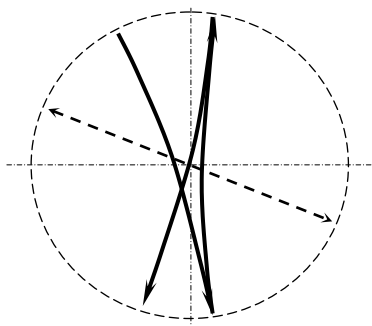

Fig. 3. Trajectory of ion oscillation of active groups within external magnetic field (solid), without it (dotted line)

Let us estimate the effect of the magnetic field on the system of ion exchange resin - solution. Without magnetic

field the Na^+ ion ranges linear path, hence the value of the site covered in a plane perpendicular to the field $\sigma_{\text{эфф}} = 2 \cdot d \cdot A \approx 4,237 \cdot 10^{-19} \text{ m}^2$, where d is effective diameter of Na^+ . Within the magnetic field a part of the ions Na^+ , moving perpendicular to the field begin to move in an arc, the radius of which is continuously changed due to the dependence of the forward velocity of the deviation from the equilibrium position. The rest of the Na^+ ions in the resin have less effect from the magnetic field due to the deviation from the perpendicular angle between the field intensity and speed.

If the ion in solution does not intersect the path of the thermal vibrations of Na^+ ion, then the exchange probability is negligible. In a magnetic field due to the continuous motion of the thermal vibrations of the position trajectory there is a nonzero probability of exchange within the circle described by the trajectory without a magnetic field, because of it the magnetic field increases ion exchange probability. In a magnetic field at low salt concentration, the total absorption of ions occurs at a smaller distance than without the field, so the appearance of the first ions at the end of the column takes a longer period of time. Increasing the concentration of salt increases the distance at which the total absorption of ions takes place. Therefore, the efficiency of the magnetic field decreases slightly.

CONCLUSION: The effect of increasing time of protective effect of ion-exchange columns in an external constant magnetic field is experimentally observed. It is shown that the effect is present is due to increasing of the effective areas and due to the Lorentz force, which occurs within the ion exchange.

REFERENCES

1. Mosin O.// Equipment for magnetic water treatment [electronic source]. URL: http://www.aqua-therm.ru/articles/articles_266.html.
2. Myshkin V.F., Han V.A., Vlasov V.A. etc. Analysis of processes responsible for the magnetic field effect on the structure and properties of water // Science journal KybSAU [electronic source]. - Krasnodar: KybSAU, 2012. - №07(81). – Regime of entering: <http://ej.kubagro.ru/2012/07/pdf/48.pdf>.
3. Myshkin V.F., Han V.A., Vlasov V.A. etc. Study the effects of electromagnetic fields on the structure and properties of water // Science journal KybSAU [electronic source]. – Krasnodar: KybSAU, 2012. – №07(81). – Regime of entering: <http://ej.kubagro.ru/2012/07/pdf/49.pdf>.
4. Klassen V.I. Magnetization of water systems, M.: Chemistry. - 1978. – 45 p.
5. Belinskya F.A., Materova E.A., Stefanova E.A. Fundamentals of ion exchange // translate from germany // Foreign Literature Publishing House – 1962. – 490 p.

METHODS OF DETERMINING THE CONTENT OF POLLUTANTS IN THE COMBUSTION PRODUCTS OF PLASMA WATER AND ORGANIC COMPOSITIONS OF THE REACTOR PORTABLE GAS ANALYZER «QUINTOX» KM9106

E.A. Tyudelekov

Scientific Supervisor: PhD, Associate professor A.G. Karegin

Language Advisor: Teacher A.V Tsepilova

Tomsk Polytechnic University, 634050, Lenin Av. 30 Tomsk, Russia.

E-mail: Tyudelekov_evgenii@mail.ru

Abstract

In this work a scheme of plasma stand "Plasma module based on high-frequency generator VCHG8-60/13-01" with a gas analyzer «Quintox» KM9106 is considered. The measurements of harmful substances (CO, NO, NO₂) in the exhaust gases of the plasma operating module are made.

Keywords: plasma stand, gas analyzer, plasma operating module, high-frequency generator.

INTRODUCTION

Gas analyzer is an instrument for measuring qualitative and quantitative composition of gas mixtures.

There are manual and automatic analyzers. Among the first are the most common absorption analyzers, in which the components of the gas mixture are successively absorbed by various reagents. Automatic analyzers continuously measure physical and chemical characteristics of the gas mixture and its individual components.

The main goal of the research is to provide a gas analyzer «Quintox» KM9106 and to analyze the composition of the gas mixture.

EXPERIMENTAL

The figure shows the scheme and the photo of a laboratory plasma stand "Plasma module based on high-frequency generator VCHG8-60/13-01", intended for studying plasma burning of different fuel compositions in terms of air plasma VCHF(high-frequency jet) discharge.

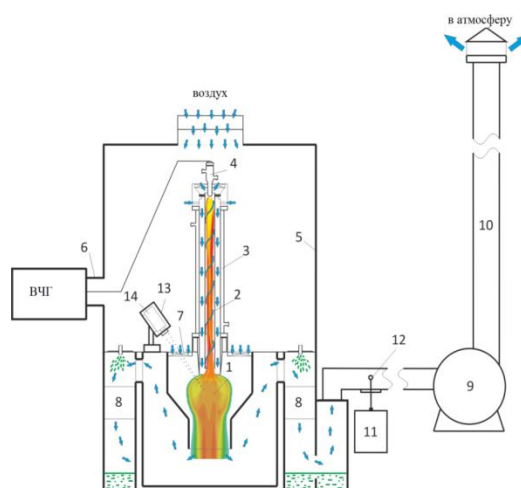

Fig.1 The scheme of a laboratory plasma stand "Plasma module based on high-frequency generator VCHG8-60/13-01."

1 is dispersant, 2 is VCHF-discharge, 3 is VCHF plasmatron, 4 is copper electrode, 5 is housing module, 6 is

coaxial output, 7 is impeller reactor, 8 is the node of "wet" cleaning exhaust gases, 9 is exhaust fan (PL 12-26, № 4), 10 is duct, 11 is analyzer «Quintox» CM 9106, 12 is sampler, 13 is protective cover pyrometer, 14 is pyrometer IPE 140/45, ICH - HF generator VCHG8-60/13-01



Fig.2 The photo of a laboratory plasma stand "Plasma module based on high-frequency generator VCHG8-60/13-01" with installed gas analyzer «Quintox» KM9106

Plasma stand includes a high frequency generator VCHG8-60/13-01 (vibrational power up to 60 kW , operating frequency $(13,56 \pm 0,13)$ MHz) , from which the coaxial output 6 RF energy is supplied to the water-cooled copper electrode 4. High-frequency jet plasmatron 3 is designed to generate air streams with average mass plasma temperature up to 4000 K. Extractor fan 9 provides a constant flow of air through VCHF plasmatron 3 and impeller 7 into the reactor.

The analyzer 11 is to determine the content in the flue gases from the reactor pollutants (CO, NO, NO₂, SO₂, C_xH_y), and controlling the CO₂ content in the plasma of combustion products (not less than 10 %) required in the reactor to ensure sufficient penetration depth of the laser beam pyrometer (not more than 0.5 m).

Pyrometer 14 is designed for non-contact measurement of plasma burning temperature in a reactor of dispersed combustible compositions along CO₂ absorption line.

Table 1 shows typical results of measurements of harmful substances in the exhaust gases during operation of VCHF plasmatron (3) in different modes ($I_a = 0 \dots 3.0$ A) , with a working unit of "wet" cleaning (WCU) and without WCU ($Q_{VV} \approx 3000$ m³ / h).

Table 1 The content of harmful substances in the exhaust gases

№p / p	Ia, A	NO, mg/m ³	NO ₂ , mg/m ³	Note
1	0	0	0	without VCHFR and UMO
1	2,6	70	2	without UMO
2	2,6	72	4	with UMO
3	2,6	71	4	with UMO
4	2,6	62	4	without UMO
5	2,8	78	2	without UMO
6	2,8	87	4	with UMO
7	2,8	75	4	with UMO
8	2,8	86	4	without UMO
9	3,0	91	4	without UMO
11	3,0	96	4	with UMO
12	3,0	84	2	with UMO
13	3,0	90	6	without UMO
14	0	0	0	without VCHFR and UMO

CONCLUSION

In the research work plasma stand "Plasma module based on the high-frequency generator VCHG8-60/13-01" with a gas analyzer «Quintox» KM9106 has been studied. The measurements of harmful substances (CO, NO, NO₂) in the exhaust gases of the plasma operating module have been made.

REFERENCES

1. V.A. Vlasov, A.G. Karengin, A.A. Karengin, N.V. Korepanova "plasma and magnetic separation DISPOSAL OF WASTE IRON AFTER WATER" // Math. universities. Physics. - 2012. - T. 55. - № 11/2. - S. 338-342.
2. "Portable analyzers« Quintox manual "" // "ENERGO TEST": 115280, Moscow

DEVELOPMENT OF ENERGY-EFFICIENT TECHNOLOGIES

V.C. Zaytsev

Linguistic Advisor: Teacher O.I. Shaykina

Tomsk Polytechnic University, Russia, Tomsk, Lenin str., 30, 634050

E-mail: vit2@sibmail.com

This article shows what methods are implemented in energy efficient technologies. To date, invented many new technologies that save energy. And several examples are given in this article.

Efficient use of energy and its development remains today one of the main objectives of public policy to enhance the economic potential of the country. Improving energy efficiency and reducing energy consumption in all areas, from production to delivery of public services is becoming a major issue in all relevant countries.

Energy-efficient equipment, materials and technologies have not yet received widespread in Russia. Only those that allow the minimum regulatory requirements for energy efficiency in buildings are widely used. The general picture of the head section Energy Expert Council under the State Duma committee on housing policy and housing, a member of the General Council of "Business Russia" Leonid Juravel [1].

One of their main instruments to stimulate the development of energy efficient technologies in modern Russia became the Presidential Decree of June 4, 2008 889 "On measures to improve the energy and environmental performance of the Russian economy." Measures set out in the decree provided for a reduction of energy consumption by 2020 gross domestic product of Russia no less than 40 percent, compared with baseline. Decree of the Federal Act is supplemented by November 23, 2009 261 -FZ "On energy saving and energy efficiency" , the Federal Law of December 30, 2009 384 -FZ "Technical Regulations on safety of buildings and structures" , the Government of Russian Federation January 25, 2011 18 On approval of rules establishing energy efficiency requirements for buildings and requirements to determine the rules of energy efficiency class apartment buildings containing the requirements of energy efficiency of buildings and should include reduction performance at least one time in five years, from January 2011 at least than 15% relative to baseline , with 1 January 2016 - 30 per cent and from 1 January 2020 - 40 per cent [2].

In different countries, almost every day new developments are announced in the field of energy and energy efficiency technologies. Here are the most extended.

Columbia, MD – January 4, 2011 – New Energy Technologies, Inc. (OTCBB: NENE) it is announced that scientists developing the Company's novel SolarWindow technology are capable of generating electricity on see-thru glass windows and they have achieved an important research breakthrough which could result in the replacement of materials prone to breakdown and degradation. Successful integration of the Company's new discovered compounds could lead to improved efficiency, lower production costs and enhance future commercial manufacturability of SolarWindow [3].

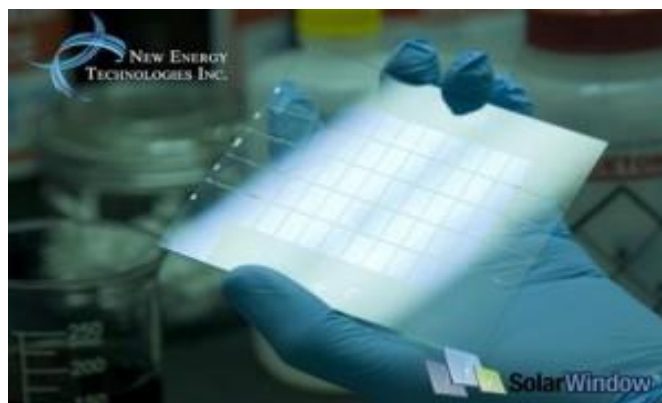

Pic. 1, Researcher prepares New Energy’s SolarWindow model in lab at University of South Florida.

“Mr. John A. Conklin explained that he had focused on developing electricity-generating coatings which remain transparent and can be applied onto glass surfaces at room-temperature. These goals were successfully achieved by our researchers and publicly was demonstrated last year,” explained Mr. John A. Conklin, President and CEO of New Energy Technologies, Inc. “This year, our sights are set on commercial product development targets, such as power output, efficiency, durability, reliability, cost, and manufacturability” [3].

Researchers are also working towards the replacement of brittle and expensive materials commonly used for generating electricity on SolarWindow with easier to handle, low-cost liquid compounds [3].

New Energy’s replacement compounds support one of the most important functions for generating electricity on glass surfaces of SolarWindow, namely, the movement of electrons. This ‘flow’ of electrons (negatively charged particles) is fundamental to generating electric ‘current’, necessary for powering appliances and fixtures.

During ongoing development testing, these new compounds have been shown to successfully ‘mobilize’ the electrons necessary for generating electricity on SolarWindow prototypes. Notably, scientists have produced these solution-based compounds without the use of expensive starting materials, and have discovered methods which allow for high reproducibility [3].

Unlike conventional materials used for generating electricity on organic solar cells, New Energy’s liquid compounds, currently under development a scientists, remain see-thru, are easy to handle, and can be applied at room temperature and without the use of high-vacuum. So all important attributes support commercial manufacturing [3].

“Nowadays the announced marks are an important achievement. We accomplish each new milestone during research and development, and prototype fabrication, brings us one step closer to commercialization of our SolarWindow technology,” Mr. Conklin concluded [3].

New Energy’s SolarWindow technology — capable of generating electricity on see-thru glass windows — is currently under development for potential application in the estimated 5 million commercial buildings in America (Energy Information Administration) and more than 80 million single detached homes [3].

To date, energy-efficient technologies are used for the construction of modern houses. Although their value can only be a dream ... Also these buildings increase the economic potential of the country.

Solar House is a construction built on the principles of "solar construction" (solar architecture), namely , the maximum possible use of solar energy to meet the needs of the house. More than 500 constructions of this type are built in Germany [4].



Pic. 2, Solar House.

By definition Institute , sunny home must meet the following conditions:

- 1) Good insulation.
- 2) Providing hot water and heating by solar energy at least 50%.
- 3) Additional heating (if necessary) only from renewable sources (wood).
- 4) Extremely low consumption of "primary" energy for heating - no more than 15 kWh / m² a.

The high degree of coating heating needs the sun's energy and is achieved by a large area of solar collectors and storage tank significant amount [4].

Solar Home Heating commonly used "warm floors" or wall heating. In a sunny house, preferably the device and partition walls of the massive heat capacity of materials. Currently, the Institute built not only individual houses and apartment buildings [4].



Pic. 3, Solar House. Apartment buildings.

In Russian experience the technology of solar construction can be used primarily in the southern regions,

as well, with some reservations, in areas with high levels of insolation, for example, Primorsky Region [4].

Many people often use use rainwater for watering their green area. But if we apply the energy-efficient technologies, the rainwater can be used in the household.

In modern energy efficient construction employs many solutions to conserve natural resources. One of these solutions is the use of rainwater, not only for watering the vegetable garden, but also for domestic use [5].

Note that from a purely economic point of view the use of such systems in Russia is hardly justified - water prices for households are low. If in Europe , on the one hand, the payback time systems using rainwater is 10-15 years (water prices over the last twenty years there have grown by more than hydrocarbon fuels), and, on the other hand, environmentally conscious citizens is high, the Russia, the situation differs strongly enough. Therefore, the use of rainwater in the home until we designed more for enthusiasts. In some quite rare, however, cases of use of rainwater can replace traditional systems of water. For example, if there is no water, and the use of traditional methods of autonomous water supply (well, well) is difficult for one reason or another. The disadvantage of the use and the risk of rain water in this case is obvious - instability and poor predictability of rainfall, respectively, the volumes of water that can be used [5].

Rainwater utilization system is quite simple. Water is collected from the roof and goes through the pre-filter in a special container, which is typically the amount of 2000 - 3000 liters. These storage tanks are made of composite materials or concrete. Fully stocked tank volume of 3000 liters can provide a family of four for 18 days (with a daily consumption of 160 liters).



Pic. 4, House using rainwater.

The tank for the accumulation of rainwater can be mounted inside the perimeter of the house (say, in new construction), or outside. It is desirable to design a system prior to construction - in this case, pre- built into the project entry point communications, allow to carry out installation more correctly and without prejudice to the building's energy efficiency. However, the system using the rainwater can be successfully mounted and if already constructed house. From the tank water is directed into the supply network at home using a submersible electric pump - rainwater utilization in everyday life. Here it is necessary to consider the following important conditions [5].

Theoretically, rainwater can be directed to the water supply network at home through a purification

system.

Of course, if you are not connected to the central water. If the water in your home is autonomous, and if you do not drink the tap water (use of rainwater for drinking and cooking is not recommended) to this there are no obstacles [5].

Traditional European solution is to install a separate (parallel) pipeline network, when rainwater is directed for specific purposes of consumption: a toilet, washing machine, washing machines ... [5]

The world is changing, and we change with them! Development of energy-efficient technologies has already received widespread acceptance and adoption in the developed world and is now becoming a hot topic in Russia. Increasing consumer awareness of modern energy solutions - one of the priorities of YIT in Russia. In residential construction under the Energy Efficiency understand complex economically sound measures aimed at reducing energy consumption buildings [6].

The use of energy efficient technologies in the global attitude to provide not only allows saving of resources and their rational use, but also a positive influence on the ecology of the environment [6].

Thus energy-efficient technologies do not only improve the lives of people, but also contribute to the country's economic potential. To date, there are no obstacles that could hamper the development of energy efficient technologies. Many commercial projects are announced nowadays that can help the development of our country!

REFERENCES

1. Link to the electronic resource: <http://expert.ru/ural/2014/13/effekt-platsebo>
2. Link to the electronic resource: <http://www.myshared.ru/slide/354610/>
3. Link to the electronic resource: <http://www.newenergytechnologiesinc.com/new-energy/new-energy-researchers-develop-technology-targeting-improved-efficiency-and-lower-production-costs-of-solarwindow>
4. Link to the electronic resource: <http://www.e-institut.ru/solnechnyj-dom>
5. Link to the electronic resource: <http://www.e-institut.ru/inzhenernye-sistemy-tehnika/2-uncategorised/79-ispolzovanie-dozhdevoj-vody>
6. Link to the electronic resource: http://www.yit-moscow.ru/yit_moscow/energoeffektivnost

СЕМНАР
***INTEGRITY OF TRADITIONS AND INNOVATIONS AS THE BASIS FOR THE
DEVELOPMENT OF MODERN ENGINEERING SCIENCE***

METHODOLOGY OF IDENTIFYING CRITICAL OBJECTS OF INFRASTRUCTURE

S.D. Babkin, V.V. Kiriyyenko

Scientific Supervisor: Senior teacher A.V. Godovyh

Language Advisor: Senior teacher N.V. Daneykina

Tomsk Polytechnic University, Russia, Tomsk, Lenin str., 30, 634050

E-mail: BabkinSergey38@mail.ru

Annotation. This work is aimed at creating of methodology of identifying critical objects of infrastructure.

Various infrastructure - a guarantee a successful existence of any state. The main vulnerability of infrastructures - are critical elements within their structure. Failure of critical element leads to a significant drop in efficiency of functioning of infrastructure. Therefore, security of critical infrastructure elements is the basis for the security of infrastructure.

Infrastructure have been considered as non-deterministic complex systems that enter interaction with their environment and consist of a large number of objects and relations between them.

Methods of system analysis and system engineering were the main instruments of research infrastructures in this paper.

The developed methodology involves three major stages: decomposition, analysis and synthesis. All necessary information about the infrastructure will be obtained by performing these stages. Methodology allows us to study any infrastructure from side of its functions and from side of its structure.

The result of research of infrastructure by this method should be full infrastructure model that accurately represents structure and functioning of infrastructure. This model is sufficiently complete for using by specialists in the development of recommendations for improvements in the safety of critical objects of infrastructure.

The methodology is simple and not labor that allows verifying vulnerability of infrastructure in the shortest time.

Keywords: Infrastructure, object, relation, structure, methodology, security, environment, system analysis, system engineering, model.

Introduction

Currently, governments of many countries are paying special attention to the security of critical infrastructure. Disruption of the functioning of critical infrastructure can cause great harm to national security, the economy and the citizens of the state.

Infrastructure - a complex system of objects and relations between them, which provides performance of any human activity [1].

The list of critical infrastructures include:

- Power equipment and networks, for example, Electric Distribution Networks, gas pipelines, oil pipelines, fuel collectors, etc.;

- Communications and information technology, for example, telecommunications, radio and television broadcasters and networks, the Internet and other information networks, etc.;
- The financial system, for example, banking, the capital markets, the investment etc.;
- Health care, especially hospitals, blood supplies, laboratories, a sanitary and rescue services;
- Products, for example, food industry, agriculture, trade, a supply of food;
- Water, especially dams, hydro resources and water supply,
- Transport, especially aviation, highway, railway, combined communication nodes and transport management system;
- Production, storage and transportation of dangerous goods, especially chemical, biological, radiological, nuclear materials;
- Governance, especially the critical services and equipment, information networks, important economic objects, strategic objects and cultural monuments [2].

Each critical infrastructure is a complex system of various objects. Some of these objects have great importance for the functioning of critical infrastructure. These objects are called critical objects (CO). Disruption of the functioning of such objects can cause serious decline in efficiency of the functioning of critical infrastructure, until complete failure. Therefore the problem of identifying critical objects and ensuring their safety have particular importance.

In general, the security of critical infrastructure is the result of an analytical process, which comprises the following steps:

- Identification of CO of critical infrastructure at the national, regional and local level;
- Identification of relevant risks to CO;
- Vulnerability analysis of single CO of the critical infrastructure;
- Risk assessment of CO violation or destruction;
- Taking appropriate safety measures, i.e. creation of a protection system of critical infrastructure.

The goal of this work is the creation of methodology for identifying critical objects of infrastructure.

The main objectives of this work are:

- collection of information on the subject;
- selection tools of system analysis and system engineering required to implement a methodology;
- creation of a common concept of the methodology.

Methodology of identifying of critical objects of infrastructure

Any infrastructure that performs some activity can be represented as an organized system of smaller objects, interconnected and exercising some functional subtasks. However, some objects are more important for the functioning of the infrastructure, while others - are less important.

Objects that are most important for the functioning of infrastructure, called the critical objects. Failure of the critical object necessarily result in malfunction or total failure of infrastructure.

Therefore, the establishment of effective security system of infrastructure requires the identification of all critical objects, as well as the creation of a set of measures aimed at protecting such objects against threats arising in relation to them.

Identification of critical objects of infrastructure can be achieved by applying of methods of System Analysis and systems engineering [3].

Three main stages were identified in the methodology for the identification of critical objects in the framework of this paper:

- decomposition;
- analysis;
- synthesis.

Systems engineering terminology used in this paper, therefore, the term "system" will be used instead of the term "infrastructure".

Stage of decomposition

Overall representation of the system is produced on the decomposition stage. This stage includes:

1. Identifying and decomposition of the objective function of the system. Decomposition is realized by constructing tree of objectives and wood features.
2. Separation of system from environment (division into system / "no system").
3. Identification of factors influencing the system. These factors may include:
 - Technogenic situation;
 - Factor of natural disasters;
 - Social situation;
 - Political situation;
 - The crime situation;
 - Climate;
 - Fauna & Flora.and other factors
4. Description of the development trends of the system.
5. Functional and structural decomposition of system.

Functional decomposition. This type of decomposition is based on the analysis of system functions. However, the technology of functioning is not investigated. Base of decomposition into functional subsystems is common functions performed by the groups of system elements.

Structural decomposition. The result of this type of decomposition is a hierarchical model of a system structure, which can be displayed as a graph. This model shows the subsystem, communication between them and their properties [4].

Stage of analysis

Stage of analysis produces a detailed representation about system. This stage includes:

1. Functional-structural analysis of the system. It allows to formulate the requirements for the system. It includes a refinement of the structure, laws of functioning of elements, algorithms of functioning and mutual influence of subsystems, analysis of the integrity of the system.
2. Morphological analysis - analysis of the relationships of components and relationships between system and environment [5].

Stage of synthesis

Synthesis stage is the last stage in the methodology of the identification of critical objects. Engineer has full detailed representation of the investigated infrastructure at this stage and he can identify critical objects using their knowledge about the system. He can use the theory of reliability of complex technical systems for this.

Identified critical object will be characterized by three attributes:

- Critical capabilities are capabilities of object, which makes it crucial in the context of a specific scenario, situation or problem.
- Critical needs are conditions, resources, methods, or mode of acting that allow the object to achieve the critical capabilities.
- Critical vulnerability is the most vulnerable need or component, disablement of that does not allow objects to achieve the critical capabilities or complete the task [6].

Engineer can make any complex of measures for improve the safety of critical objects after their full description. It can significantly improve the security of the infrastructure.

General view of methodology of the identification of critical objects is shown in figure 1.

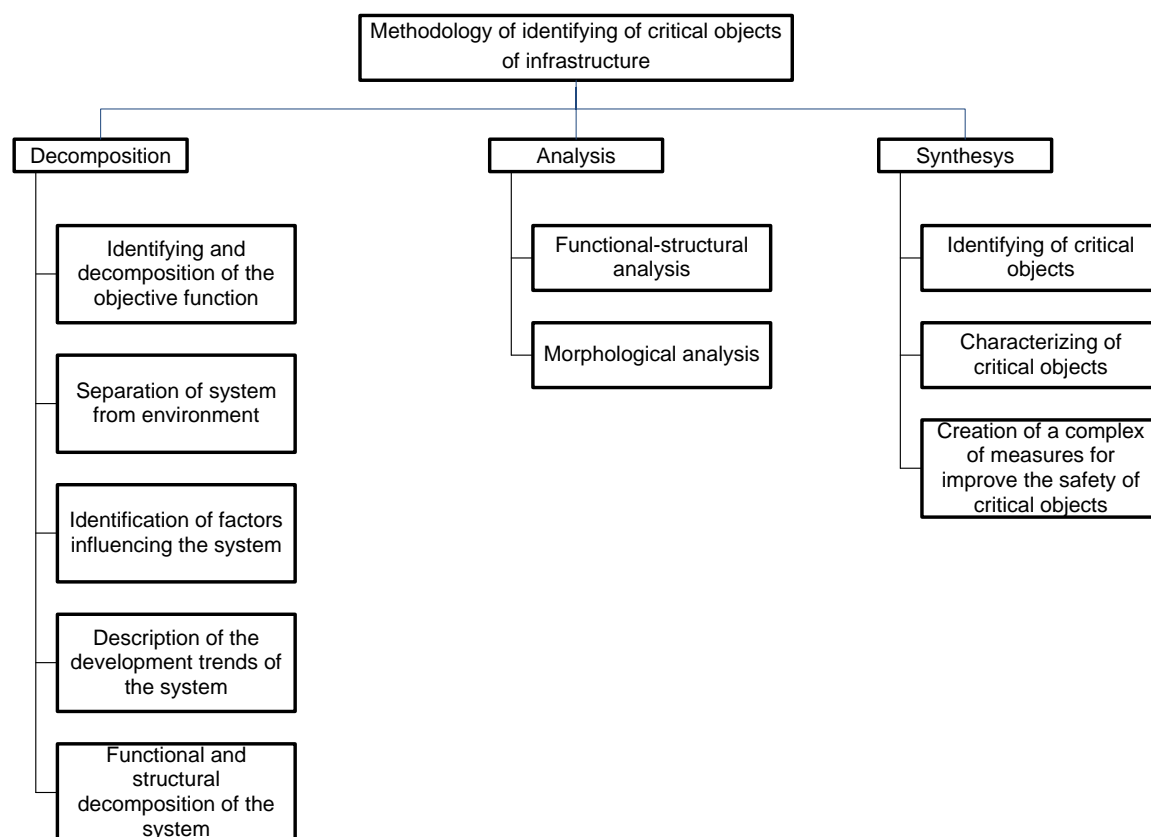

Figure 1. General view of methodology of identifying critical objects of infrastructure.

Conclusion

Critical infrastructure - infrastructure, disruption, failure or destruction of which could have a major impact on public health, social and political affairs, the environment, security and socio-economic wellbeing.

Any infrastructure is a complex system of different objects and relationships between them.

Objects, safety and stable functioning of which is crucial for the functioning of infrastructure, called the

critical objects. Security of critical objects is a priority in ensuring security of infrastructure. The main problem is to identify the critical objects.

This work aims to create a methodology for the identifying of critical objects using methods of systems engineering and systematic approach to the study of the infrastructure. Development of a methodology to identifying critical objects continues at present.

This paper contains a description of obtained results.

References

- 1) Lewis T. G. Critical infrastructure protection in homeland security: defending a networked nation. – John Wiley & Sons, 2006.
- 2) Postanovleniye Pravitel'stva Rossiyskoy Federatsii ot 23 marta 2006 g. № 411 «Ob utverzhdenii perechnya kriticheski vazhnykh i opasnykh ob"yektov Rossiyskoy Federatsii» / Russian Federation Government Resolution of 23 March 2006 № 411 "On approval of the list of critical and dangerous objects of the Russian Federation".
- 3) Hokstad P., Utne I. B., Vatn J. (ed.). Risk and Interdependencies in Critical Infrastructures: A Guideline for Analysis. – Springer, 2012.
- 4) Blanchard B. S., Fabrycky W. J., Fabrycky W. J. Systems engineering and analysis. – Englewood Cliffs, New Jersey : Prentice Hall, 1990. – Т. 4.
- 5) Hall A. D. A methodology for systems engineering. – 1962.
- 6) Utne I. B., Hokstad P., Vatn J. A method for risk modeling of interdependencies in critical infrastructures //Reliability Engineering & System Safety. – 2011. – Т. 96. – №. 6. – С. 671-678.

GRAVITATIONAL FUSION REACTOR. CONCEPT AND PERSPECTIVE

A.Y. Borodaj, R.V. Gizbreht

Linguistic Advisor: Y.V. Ermakova

Tomsk Polytechnic University, Russia, Tomsk, Lenin str., 30, 634050

Introduction

For the existence of mankind requires energy. With the development of scientific and technological progress of mankind population growing energy needs are growing even faster.

The main source of electricity humanity is a hydrocarbon fuel. But the reserves of this fuel on the planet is rapidly disappearing, and it requires the same in the chemical industry. Getting the same energy from hydrocarbons is almost always accompanied by the release of large amounts of waste, which spoil the ecology of the planet.

Nuclear power tamed by mankind relatively recently. This is a very promising source of electricity. Stockpiles of nuclear fuel from the point of view of the maximum possible energy extracted from them many times the reserves of hydrocarbons. But the nuclear fuel cycle can afford not every state, because nuclear industry requires a large initial investment, a large number of well-educated professionals and sophisticated technology. Especially difficult is dealing with spent nuclear fuel, which must somehow take AESi to bury, without killing the local ecology. In addition, stocks of nuclear fuel is also not infinite. Hydropower is cheap, not very difficult technically realizable, but not all have enough rivers. So that this source is not unlimited.

Other sources of energy can not even consider - their physical and economic efficiency are good only for interesting articles in journals and not for the industry for all of humanity.

For fusion energy are suitable for almost all light nuclei, so the fusion fuel reserves are virtually limitless. Specific energy of thermonuclear fuel higher than nuclear fuel, specific energy which is millions of times greater than that of the hydrocarbon.

Based on the experience of nuclear energy can be assumed that the development of a fundamentally new high-energy industry can be associated with serious accidents. Because in the 21st century, from the time when the first moon landing took place about 55 years, and landing on Mars has been more than 45 years, we can conduct large-scale experiments on the domestication of new energy sources outside of the planet on which we live.

The aim of this work - to describe one of the possible forms of development of fusion energy

The objectives of this work is the description of a possible fusion reactor and justification of reality and the prospects of the project.

The main part. Concept

For realization of fusion needs enormous temperature of about 100 million degrees Kelvin. For realization of fusion efficiency requires positive, the criterion Lawson ($n\tau > 10^{14}$ s/cm³, where n - density of the high-temperature plasma, τ - time keeping it in the system). Thus, the main task in the domestication of fusion is to keep the fusion fuel in the reaction. To do this, mankind has invented to use a magnetic field.

However, if you put the fusion fuel in the center of a massive space object, then hold except the magnetic field will also participate gravity object. This will significantly reduce energy costs on hold thermonuclear reaction, and hence the reaction will maintain a relatively long period of time. This will undoubtedly have a huge contribution to the research and development of fusion technology.

The main part. Choice of fuel

There are many possible thermonuclear reactions. Most of them viewed the following:

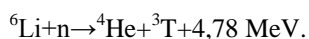
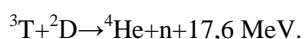
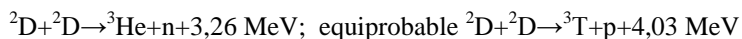

Tritium is radioactive, neutrons of these reactions also pose a serious radiation hazard. Because most radiation-reaction can be considered pure reaction ${}^2\text{D}+{}^3\text{He}$. Of course, in such fuels will inevitably ${}^2\text{D}+{}^2\text{D}$ reaction, and are respectively ${}^3\text{T}+{}^2\text{D}$. But it is important that such fuels can be reduced up to 50 times the output of radiation-hazardous products. As a result, biological hazards fusion reactor can be reduced by four to five orders of magnitude as compared to nuclear fission reactors, eliminating the need of industrial processing of radioactive materials and transporting them qualitatively simplifies disposal of radioactive waste, if any, will be.

However, for the implementation of the clean reaction temperature needed is 5 times larger than for the D-T reaction, that is easiest to initiate (500 million degrees to 100 million degrees), but it's not too serious problem.

Deuterium contained in the water, the technology of its receipt the spent long.

${}^3\text{He}$ is gradually accumulated in the regolith over billions of years of exposure the solar wind, a ton of lunar soil contains 0.01 g of ${}^3\text{He}$ and ${}^4\text{He}$ 28 g, this isotopic ratios (~ 0.04%) is significantly higher than in the Earth's atmosphere. Thus, ${}^3\text{He}$ can easily find any type of satellite moon and the moon itself, and hence it is possible to obtain it.

The main part. Selecting an object

As a prospect for the implementation of suitable satellite of Mars, Deimos.

Moon is not suitable because has a core of liquid molten metal. Even if you get an incredible, and it will cool the core, it will inevitably lead to a change in the magnetic field of the Moon. And that could lead to disaster in the world.

Phobos and Deimos are not liquid core, both have a low density. Because these objects are relatively similar to Earth's moon, then we can safely assume that they are sufficiently ${}^3\text{He}$. But Phobos is inside the Roche limit, so that the satellite can easily collapse when trying to create the mine to the center of the satellite and the cavity inside.

Because Deimos has no hot core and, in principle, "cold", has a low density, the drilling should not cause serious problems.

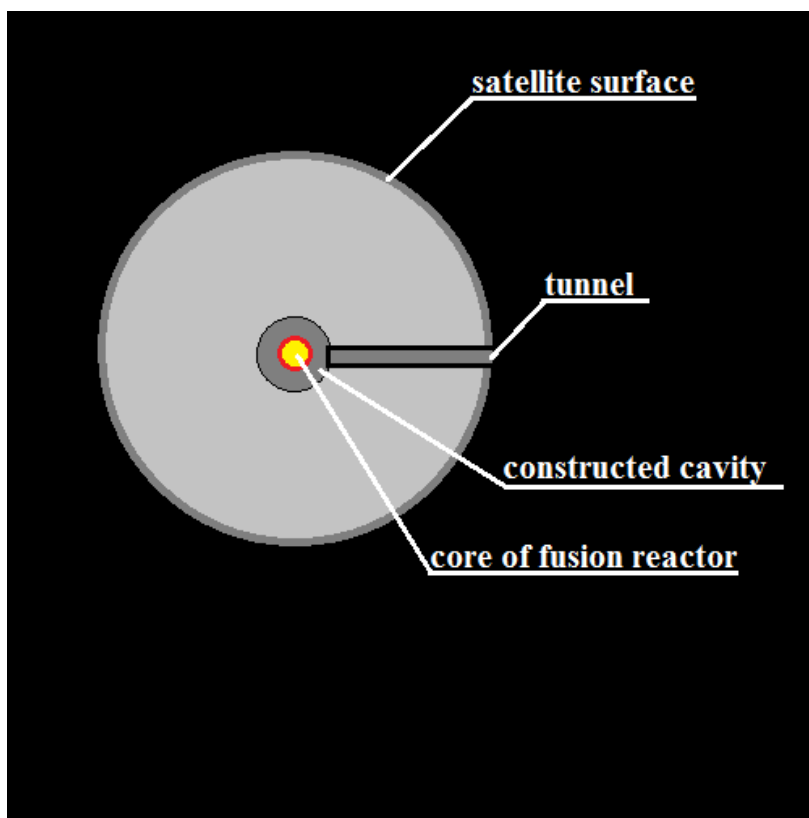

Results

As a result of research it can be concluded that the most promising is the creation of a fusion reactor in the gravitational center of Deimos. The fuel can be used a mixture of ^3He and D. Helium can get satellite, deuterium can be brought from Earth.

The creation of this reactor will not only help the development of terrestrial technology in fusion, but also be able to help in the exploration of Mars, as will be the first and at the same time very powerful power plant in orbit around Mars.

Conclusion

In conclusion, it should be noted that this technology almost sounds fantastic. But at the same time, humanity, in general, that has absolutely everything to try to implement this project.

Project start-up loop Lofstroma can provide cheap space launch the necessary equipment. Flying in space and landing on various space objects mastered half a century ago. Drilling in extreme conditions mastered Kola borehole.

Major powers can afford to spend more than \$ 500 billion a year on the military (USA) . Or build a road 48 miles per \$ 9 billion (Russia) , which is more expensive programs flight to Mars (USA). But here is to spend \$ 10-20 billion on International Thermonuclear Experimental Reactor can not even the whole world.

The Cold War ended, scientific and technical progress in the field of energy and space exploration moves only by inertia. And soon he will get up and go back, because any system or developing or degraded. And because this project is likely fantastic. It can be realized. But almost nobody wants. Modern people do not think about the development and the future, but about greed and present.

References

1. E. R. Dobbs — «Helium Three.», Oxford University press, 2000. ISBN 0-19-850640-6
2. G. Audi, A.H. Wapstra, and C. Thibault — «The AME2003 atomic mass evaluation (II). Tables, graphs, and references.», Nuclear Physics A , 2003
3. M.M. Basko — «Physical basis of inertial confinement fusion. Tutorial», 2009
4. I.N. Bekman — «Physical basics of nuclear fusion», 2009.
5. www.nasa.gov

DETERMINATION OF NUCLEAR MATERIALS' ELEMENTAL COMPOSITION FOR THE NEEDS OF NUCLEAR FORENSICS

D.O. Dolmatov

Scientific Supervisor: Ph.D. Demyanyuk D.G.

Tomsk Polytechnic University, Russia, Tomsk, Lenin str., 30, 634050

E-mail: dolmatovdo@tpu.ru

Annotation

According to International Atomic Energy Agency there were 419 incidents of illicit trafficking of nuclear and other radioactive materials in 1993-2012. The problem of illicit trafficking of nuclear materials concerns international community due to the increasing of risks which are connected with proliferation of nuclear weapons and nuclear terrorism. IAEA adopted a plan of activities to fight against illicit trafficking of nuclear and other radioactive materials. Nuclear forensics is included to this plan. Nuclear forensics is analysis of illicit nuclear materials to determine their origin, place of production and routes of transportation. One of the parts of this investigation is elemental analysis. Elemental analysis is important due to the fact that presence or absence of some elements in nuclear material may indicate about origin or some features of nuclear materials. In this article the most useful methods for elemental analysis are reviewed.

Introduction

The problem of illicit trafficking of nuclear and radioactive materials became important in the early 1990's. According to the International Atomic Energy Agency 419 incidents of illicit trafficking of nuclear and other radioactive material were registered. Sixteen of these incidents were connected with high enriched uranium and plutonium.

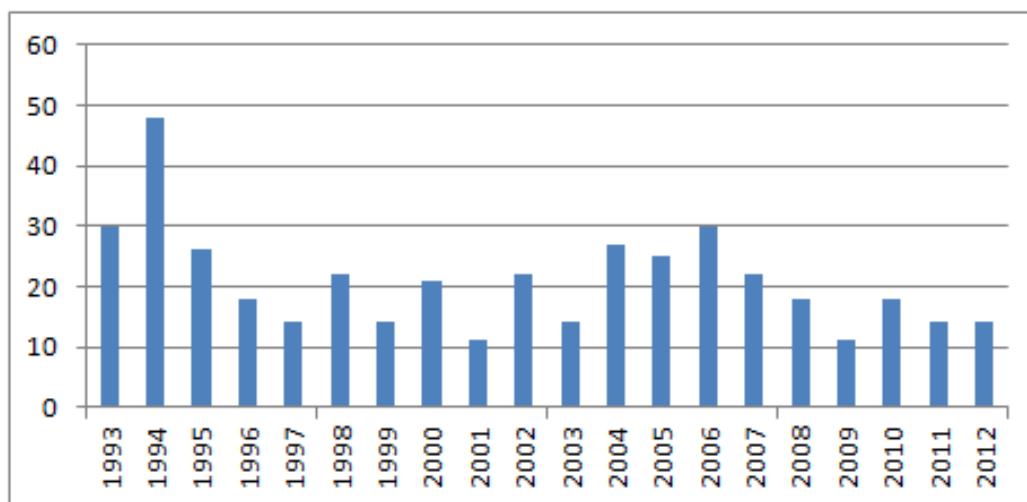

Picture 1. Illicit trafficking of nuclear and other radioactive material in 1993-2012

After the acts of terrorism in USA in 2001 international community started to pay closer attention to the problem of illicit trafficking of nuclear and other radioactive materials. It was connected with the risk of nuclear

and radioactive terrorism. In 2002 IAEA adopted plan of activities to resist the possibility of nuclear materials' possession by terrorist organization. Nuclear forensics is a part of this plan. The main purpose of this activity is to determine origin of nuclear material, feature during its production and routes of its transportation. For purposes of nuclear forensics mainly destructive methods of analyses are used due to the need of precise measurements. In this case right set of methods of analysis is a vital factor for the specialists to achieve the goals of nuclear forensics.

Stages of nuclear forensics

The process of nuclear forensics can be divided into three stages. On the first stage elemental and isotopic compositions of nuclear material are determined. Also particle analyses and phase analysis of nuclear material are important parts on this stage which is called characterization. On the next stage information which was received during characterization is matched with known information about features of nuclear materials' origin and production. In other words, specialists interpret results of characterization. On the last stage experts come to a conclusion about origin, features of production and route of transportation of nuclear material. This stage is called attribution. Nuclear forensics is an iterative process. During interpretation a set of hypotheses are built. These hypotheses are verified by additional study of nuclear material which allows to exclude wrong hypotheses.

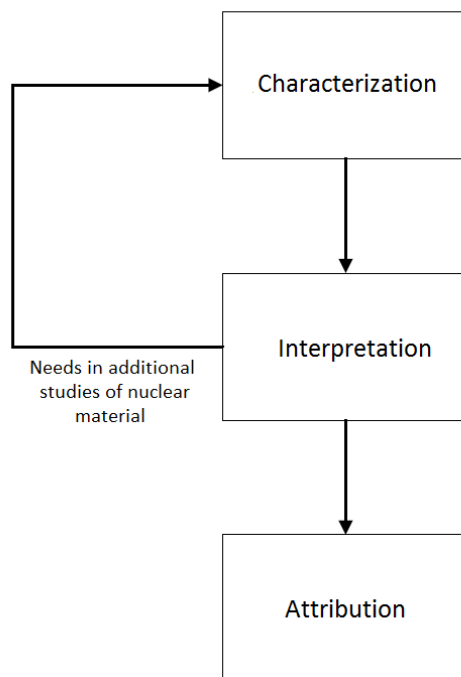

Picture 2. Stages of nuclear forensics

Methods of determination nuclear materials' elemental composition

Determination of nuclear materials' elemental composition is important part of characterization due to the fact that presence or absence of some elements in sample may be connected with origin of nuclear material or some features of its production. For example, rare-earth elements can remain in nuclear material during its

reprocessing. Amount of these elements in nuclear material can be measured and this information can help specialists to determine the origin of nuclear material.

For determination of nuclear material's elemental structure spectral methods and mass-spectrometry are used. The main advantage of these methods is possibility to conduct multielement analysis with high precision and sensitivity. Nowadays X-ray fluorescence analysis (XRF), atomic emission spectroscopy with inductively coupled plasma (ICP-AES) and mass spectrometry with inductively coupled plasma (ICP-MS) are the most widely used methods of elemental analysis.

Description of methods

X-ray fluorescence analysis is based on the phenomenon of X-ray fluorescence which is emitted after interaction between Roentgen rays and atom. X-ray knocks out electron from the inner orbital. After that electrons from higher orbital move to the lower orbital and fill the vacancy. As the result characteristic X-ray is emitted. Frequency of secondary X-ray emission depends on atomic number of atom. This relationship was discovered by Henry Mosley in 1912.

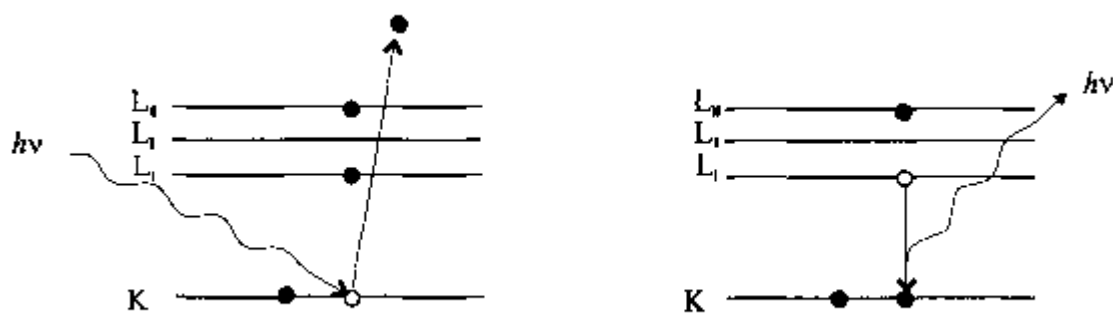

Picture 3. Phenomenon of X-ray fluorescence

Mass-spectrometry is a method of sample analysis which is based on determination of abundance between charge and mass of ions which are produced by ionization. For this purpose laws of ions' movement in electrical or magnetic field are used.

Atomic emission spectroscopy based on analysis of emission spectrums of excited atoms which are unique for every element. This uniqueness is used for qualitative analysis. During quantitative analysis intensive of elements' lines are analyzed.

For the purposes of mass-spectrometry and atom emission spectroscopy analyzed sample should be atomized. In other words it means destruction of material's molecular structure. For the purposes of mass spectrometry atoms must be ionized whereas for purposes of atomic emission spectroscopy atoms must become excited. Inductively coupled plasma can provide all conditions which were described above. Inductively coupled plasma is a type of plasma which is generated by the fluent magnetic field which is created by induction coil. The main advantage of this type of sample atomization, ionization and excitation is high concentration of sample's atoms. Also temperature inside ICP burner reaches the amount of more than 6000 degrees. This fact means the full atomization of analyzed sample. The main disadvantage of using ICP is its dependence on argon. Argon is used to create ICP, to transport sample through the tube to the torch, and to cool the burner.

Comparison of methods

Methods which can be used for purposes of nuclear forensics must meet some requirements. The first requirement is possibility to conduct multielement analysis. It is necessary due to the fact that large set of elements must be determined during analysis for the needs of nuclear forensics. The second requirement is time of analysis. This factor significantly affect on the time of nuclear forensics analysis at all. Third requirement is high sensitivity of methods. In some cases very little amount of elements is important factor which allow building hypothesis about origin and features of production of nuclear material. XRF, ICP-MS, ICP-AES spectrometers meet these demands. So, they can be used for determination of materials' elemental composition for the needs of nuclear forensics.

One of the biggest advantages of the XRF analysis is the possibility to conduct it nondestructively. In addition to this merit there are portable models of XRF spectrometers which allow making on-site nondestructive inspection of material. Generally XRF is used for solid materials analysis. Materials in powder are pressed into the tablets with the cellulose. Metallic materials can be analyzed without any preliminary actions. The main disadvantage of XRF analysis is significant influence of matrix effects to the result of analysis. Matrix effects include x-ray fluorescence's absorption in sample, secondary Roentgen fluorescence and Auger electron's emission spectrums. Matrix effects affects strongly on quantitative analysis's precision. Typical detection limit for elements is 10 particles per million. Method allows analyzing elements from sodium to uranium.

The main advantage of mass spectrometry with inductively coupled plasma is its precision. Typical detection limit for elements in this method vary from nanograms to pictograms per liter of sample. Another advantage is that mass spectrometers can be used for determination isotopic and elemental structure of material. It means that this method is rather versatile .Only liquid samples can be analyzed by using this method. In this case solid samples must be dissolved firstly for the analysis. Mass spectrometers can't be made portable due to the size of spectrometers and their dependence on large amount of argon. Method allows analyzing elements from lithium to plutonium.

Atomic emission spectroscopy with inductively coupled plasma is a rather precision method. This method's typical detection limit varies from nanograms to micrograms. This method is less sensitive than the ICP-MS. ICP-AES can't be used for determination of isotopic composition. Only liquid materials can be analyzed. Also ICP-AES spectrometers cannot be made portable due to the reasons which were described for ICP-MS. Method allows analyzing elements from lithium to uranium.

Conclusion

Methods which were described above have their own merits and demerits and all of them are suitable for the needs of nuclear forensics. However there are some features of these methods' application in elemental analysis

The main advantage of XRF analysis is its possibility of analyzing solid materials. Also XRF spectrometers can be made portable. These facts make XRF portable spectrometers very are available. But low sensitivity with big affection of matrix effects on this method makes it useless for precise analysis of material's

element composition.

For the precocious analysis ICP-MS and ICP-AES can be used. In this case mass spectrometry is more useful method. It has higher sensitivity. Another advantage of ICP-MC is its possibility to determine isotopic and elemental composition of material. Advantage of using ICP-AES spectrometers are connected with their lower salary than ICP-MS spectrometers.

REFERENCES

1. Nuclear Forensic Support. (2006) International Atomic Energy Agency
2. Kenton J. Moody, Ian D. Hutcheon, Patrick M. Grant. Nuclear Forensics Analysis. Taylor & Francis group, 2005
3. M. Otto. (2003) Modern methods in analytical chemistry
4. Application of Nuclear Forensics in Combating Illicit Trafficking of Nuclear and Other Radioactive Material. (2014) International Atomic Energy Agency

METHODS OF MECHANICAL GRINDING AND DISPERSION ANALYSIS OF SOLIDS

S.V. Inozemtsev, A.A. Malik

Scientific Supervisor: Senior teacher M.S. Kuznetsov

Linguistic Advisor: Teacher Y.V. Ermakova

Tomsk Polytechnic University, Russia, Tomsk, Lenin str., 30, 634050

Introduction

Dispersion of solids - their grinding to particles with smaller sizes. It is carried out to increase the speed of heterogeneous processes. In most practical cases, the use of solid materials in the solid phase and heterogeneous reactions without prior grinding is impossible. As almost all commercially used materials are normally in solid state, grinding is one of the basic operations of their reprocessing. There are various methods of obtaining solids in a dispersed state, of which the most simple, economical and, therefore, the most common is mechanical grinding.

Currently, the world production of powders reaches a billion tons per year. Approximately 10% of generated electricity is spent on this. Several million tons of steel is annually spent on manufacturing grinding solids. Grinding is used in such tonnage industries like mining, cement, glass, food, and in the production of sintered metal, ferrite products, solid fuels for jet engines, explosives, nuclear fuel elements, medicinal powders, poisons, etc.

Depending on the nature of the material and the nature of its use there are different requirements to grinding which are more often quite specific i.e. dispersion, purity, safety, etc. In most cases, the task of obtaining possibly finer powders is set, however, under the conditions of limitation of energy consumption and time. All this led to the need to study the laws of the grinding process and the properties of the powders, and necessitated the development of methods of dispersion analysis. The purpose of scientific papers in the field of grinding solids is to determine the conditions and the development of methods for their most rational use and dispersion.

Along with dispersing and aggregation during grinding, as in any other kind of mechanical treatment, change of crystal structure and energy state of the surface layers of particles occurs. Their study is of interest for physics of surface phenomena and is very important for understanding the mechanism of grinding. Condition of the surface layers significantly affects the interaction between the particles and the medium, and, thus, on dispersion of powders. Knowledge of chemical and physical properties of surfaces in a number of cases is necessary to determine the conditions of practical use of grinded materials.

Basic Methods of Mechanical Grinding and Dispersion Analysis of Solids

Features of a chemical reaction in the solid state under the influence of mechanical energy is generally regarded as the realization of the process in time of thermal rupture under the influence of voltage fluctuation of chemical bonds.

Two questions arise here: a) what chemical processes are initiated and thus occur in the future and b) how the preliminary mechanical treatment can alter the reactivity of solids. In a first possible case, from the analysis of the physical processes that take place during the mechanical destruction of solid substances was

found that chemical changes result in the destruction of crystals and the friction due to the formation of cracks. The model is presented in which in the point of contact with friction there are conditions conducive to impulse excitation of nonequilibrium states. Such states are most often localized on microdefects and characterized with strains many times exceeding the average value of the failure stress. Upon reaching a value corresponding to tensile strength of this compound the process of the formation and propagation of cracks is initiated.

Further course of the process of destruction of the particle kinetic regime is supported by mechanical action due to continuous updating of the contact surface. The second of these questions comes down to the main factors affecting the reactivity of the solid, i.e.: a) dispersion, b) defect formation and c) the formation of mechanolysis products in solid substance. Dispersing - fine grinding of solids and liquids in the environment, leading to the formation of homogeneous dispersion systems: powders, suspensions, emulsions, etc.

Formation of defects can be represented as the process by which matured portion of the atoms or ions leave the regular positions in the lattice and move in an intermediate position - internodes. For elementary crystal vacancy concentration is expressed by the type of state of solids characterized by the presence of non-equilibrium defects called active as opposed to the normal state, which is determined by the equilibrium disorder of the lattice. Measure of activity is a measure of the excess free energy of one mole of substance in a given state as compared to normal. This energy is equal to the affinity of the process: the active substance – thermodynamically stable substance.

Thus, when the mechanical treatment of substance as a result of mechanical influence in the contact region of a solid body, stress field is created and its subsequent relaxation occurs, which is the main ways of heat, crystal defects, the formation of new surface excitation of the chemical reaction. These processes occur in the complex, but preferred direction of relaxation depends on the properties of substance and loading conditions. Presumably, with increasing power of mechanical action there is a gradual transition from the thermal relaxation channel to the channels associated with the accumulation of lattice defects, destruction and interaction. Part of the energy remains in a solid form in excess free energy. It is associated with morphological and electronic defects and maintained for a long time, especially at low temperatures. Such "activated" state leads to the increase in the chemical reactivity of the material. The main reason for the mechanical activation is to increase the enthalpy of the solid as a result of accumulation of crystal defects - vacancies, interstitials, dislocations, grain boundaries and subgrains, as well as increasing of the surface area and degree of disorder. Increasing the number of point, one-dimensional and two-dimensional crystal defects are major contributors to the increase in enthalpy. Come to the surface, line and point defects lead to changes in the energy state of the surface layers. Atoms in the field of elastic distortions around the dislocations become active centers and have a significant impact on the chemisorption and catalysis. As noted above, when the mechanical treatment of solid bodies, the work is mainly spent not so much on a new surface or structural defects as the creation of high-energy, active short-lived excited states [2]. The occurrence of such conditions and the accumulation of power is about 10-15% of the work strain. Multiple plastic deformation of the individual particles results in a significant increase in the contact surface between the reactants. In conjunction with the presence of the particles of the areas on the surface containing microdistortions of crystal lattice and characterized by high values of density of dislocations and free energy, may be sufficient for mixing substances at the molecular level and intensification of the diffusion-

controlled reactions during mechanical treatment. Conditions to facilitate this process, are special deformation mechanism and higher temperature. In places of contacts of grinding solids significant local pressure (up to $15,000 \text{ kg/cm}^2$) and elevated temperatures are developed (up to $1000 \text{ }^\circ \text{C}$), the existence of such high temperatures with area 10^{-3} - 10^{-5} cm^2 is 10^{-4} . As a result, leakage of solid state reactions with the formation of intermediate, metastable compounds is possible in microvolumes.

In reality, a reflection of the complex physical and chemical processes occurring during the machining process, is the change of morphology and particle size of the processed composition. In general, their formation is described by the following scheme. When handling the powder mixtures in mechanoreaktor, processes of destruction and formation of particles by welding granular composition flow simultaneously.

At different processing stages, only one of the them prevails. In general, when plastic deformation, density of crystal defects continuously grows. When a critical value as a result of the interaction of force fields of dislocations in local volumes of crystals is achieved, submicron fractures, in which destruction of particles occurs, appears. In parallel with the destruction of the particles, resulting in adhesion processes, agglomeration and granulation occur. Adhesion of the particles is mainly due to van der Waals and electrostatic forces and receives its development, primarily in the areas of contact with fresh surfaces [3]. On impact of the grinding solids in these places agglomerated composition cold welding occurs, accompanied by diffusion processes. In practice, by means of the stage of mechanical treatment of solids, the possibility of obtaining homogeneous, finely divided, highly powder particles is realized, thereby reducing the time and temperature of the synthesis / sintering and formation of qualitative microstructure of the article and ultimately improving the structure-sensitive properties of the material as a whole.

REFERENCES

1. Fizika izmel'chenija, Hodakov G. S., 2005 g., Har'kov.
2. Mehanohimija i mehanicheskaja aktivacija tverdyh veshhestv, Boldyrev V. V., 2006 g., Novosibirsk.
3. Fiziko-himicheskie osnovy izmel'chenija/peremeshivaniya oksidnyh materialov i metody kontrolja kachestva poluchaemyh poroshkov, metodicheskie ukazanija, 2008 g., Minsk.

NUCLEAR ROCKET ENGINE

A.D. Isakov, A.A. Prozorov, E.P. Shutova

Scientific Supervisor: PhD, Associate professor Mark E. Totmeninov

Linguistic Advisor: Senior Teacher O.P. Kabrysheva

Tomsk Polytechnic University, Russia, Tomsk, Lenin str., 30, 634050

E-mail: rhawww@gmail.com

Abstract

This article describes a solution to the problem of insufficient capacity of existing rocket engines for interplanetary missions. Development in the sphere was analyzed by comparing the examples of the rockets of 1970 and present time. Further development of the nuclear engine is discussed.

Keywords: *liquid rocket engine, nuclear rocket engine, nuclear lift, interplanetary flights, Z-pinch effect.*

INTRODUCTION

Classic liquid rocket engines opened the way to space for mankind but now they are absolutely unpromising. They can be used only to launch a satellite or to fly to the Moon. These engines are useless for long flights: its exhaust velocity does not exceed 4.5 km/s, instead of the required dozens of kilometers per second. In addition, there is an impact of economic factors: according to the Tsiolkovsky equation, to reach the final velocity greater than the flow rate of the exhaust, the expendable mass should be significantly more than remaining. However, in the scale of interplanetary flights, the total cost of fuel is enormous.

The formula of thrust includes the average velocity of gas molecules emitted from the nozzle of the rocket engine. It can be increased in two ways: by increasing the temperature in the combustion chamber or lowering the molecular mass of the exhaust. However, the mass reduction does not lead to a substantial gain in speed because even if we are using the best oxidant (O₂) and fuel (H₂) the maximum increase in the velocity is only half of it, which is insufficient for long-range flights. So modern engine constructors are increasingly re-considering the first way – to heat exhaust up to a high temperature. Still, how to implement it? The answer to the question seems obvious now - nuclear energy. According to the calculations it turned out that it would be twice as efficient as oxygen–hydrogen fluid rocket engine (FRE). [1]

NUCLEAR ROCKET ENGINE

Nuclear rocket engine (NRE) is a kind of a rocket engine which uses the energy of nuclear fission or fusion to create jet thrust. NRE was developed in the USSR (RD-0410) and the USA (NERVA) in the mid-1950s. The research is continued at the moment. There are two types of NRE: pulse-explosive and liquid.

PULSE-EXPLOSIVE NRE

This type of engine was developed in the U.S. and the USSR during the 1950-70's. The most famous project of PENRE was the American ship "Orion". The spacecraft ejects a small nuclear charge that explodes within a short distance from the spaceship (up to 100 m) in the opposite direction of the flight. The charge is designed the way that most of the products of the explosion in the form of expanding plasma front is sent to the tail of the spacecraft where the massive reflecting plate accepts pulse and transmits it to the ship through the shock absorbers. Additional thrust is created by the ablation (evaporation) of the plate surface under the influence of gamma and X-rays. Reflecting plate is coated with graphite grease which protects it from the damage from

gamma radiation and high-temperature plasma. When the height and the speed have been increased, the frequency of the explosions can be decreased. The ship is predesigned to fly vertically during the takeoff to minimize the area of radioactive contamination of atmosphere. According to calculations, nuclear pulse spaceship would reach Alpha Centauri in 130 years, reaching the speed of 10 000 km/s. However, further funding of the project was denied.

In the USSR, a similar project contained additional chemical thrusters that lifted it 30-40 km above the Earth, and then the basic nuclear pulse motor was activated.

The main problem of these projects was the strength of the screen-pusher which didn't stand against enormous heat loads from nearby nuclear explosions and radioactive waste pollution. None of these projects had been completed by the end of 1960. USSR and the USA stopped funding. The actual testing of pulse NRE with detonating a nuclear device was not conducted. [2]

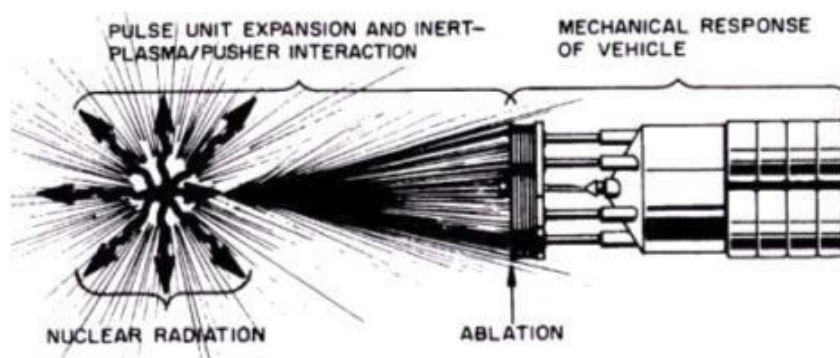

Picture 1: structure of pulse-explosive NRE

NUCLEAR JET ENGINE

The principle of operation of NJE is a high temperature heat-exchanger into which a working fluid (liquid hydrogen) is introduced under high pressure and then heated to a high temperature (3000° C) and ejected through a cooling nozzle. Heat recovery in the nozzle is very beneficial as it allows to heat up hydrogen much faster and by utilizing a significant amount of heat, increase the specific impulse up to 1000 seconds (9100 - 9800 m/s). [3]

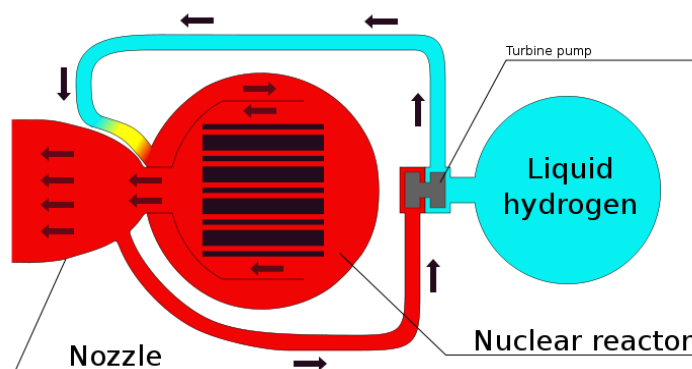

Figure 2: structure of nuclear jet engine

RANGE were positioned as engines of ships for travelling to Mars and were developed in the USSR (RD-0410) and the U.S. (NERVA). Despite the fact that both projects stood a full course of tests and proved to be

successful, no NRE has been run for the lack of funding, which was caused by the prolonged space race. [4]

Table 1: The results obtained at the reactor IVG-1 and program development in the U.S. NRE

	USSR	USA	
Period of research activity	1961-1989	1959-1972	
Money spent, billion \$	~ 0,3	~2,0	
Number of reactor units manufactured	5	20	
Fuel composition	solid solution UC-ZrC, UC-ZrC-NbC	UC2 in graphite matrix	
Calorific core, average / maximum, MW / l	15 / 33	2,3 / 5,1	
The maximum temperature, K	3100	2550	2200
Specific impulse, sec	~ 940	~ 850	
Resource at the maximum temperature of the working fluid, sec	4000	50	2400

NUCLEAR LIFT (RUSSIA)

NRE shows its best performance at high payload mass, so its most rational use is the implementation in the transport and energy module (TEM) which can provide a 30 times increase in energy level of a spacecraft and a ten times increase in the fuel efficiency of the propulsion system .

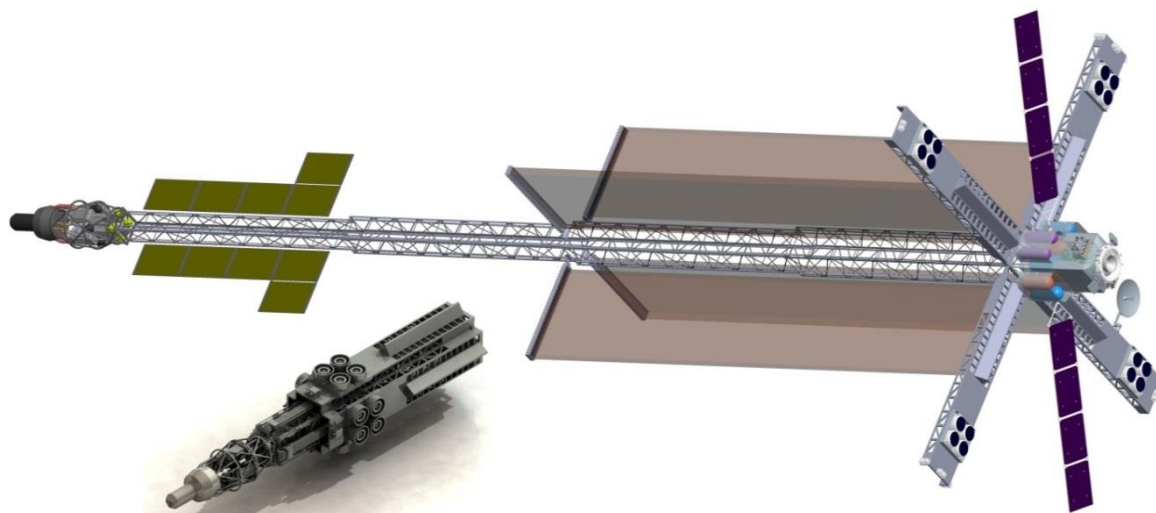

Figure 3: structure of nuclear lift

Taking into account the problems of NRE of previous generations, Russian scientists proposed the scheme of a hybrid engine in which the reactor did not heat the jet ejected from it, but produced electricity. Hot gas from the reactor spins the turbine; the turbine spins the generator and compressor that provides circulation of the working fluid in a closed loop. The generator produces electricity for the plasma thruster with a specific thrust which is

20 times greater than that of chemical analogs.

The main improvement is that exhaust from the new engine will not be radioactive, since a completely different working fluid contained in a closed circuit passes through the reactor. Also, in this scheme it is unnecessary to heat hydrogen up to extremely high temperature, as the inert working fluid circulating in the reactor is heated up to 1500 degrees. [5]

A ground prototype reactor plant is planned to be created by 2015, and by 2018 the reactor facility is to be constructed and its test is to be started in Sosnoviy Bor. The first flight test of TEM may be conducted in 2020. The major organization responsible for developing the nuclear reactor itself is the Scientific Research and Design Institute for Energy Technology (NIKIET), a member of Rosatom. [6]

Table 2: Specifications of nuclear lift [7]

Weight, kg	20290
Dimensions (position), m	53,4 × 21,6 × 21,6
Electric power unit, MW	1,0
Specific impulse electric propulsion, km / s	min 70,0
Power electric propulsion, MW	max 0,94
Overall thrust propulsion electric propulsion, H	min 18,0
Resource, years	10
Launch vehicle	RN "Angara-A5"

THE ENGINE ON THE Z-PINCH EFFECT (USA)

The pinch effect is the compression of plasma as the result of the interaction between the discharge current and the magnetic field. If the current flows along the axis of the cylindrical plasma column, it is called a Z- pinch. Z- pinch can be observed, for example, when lightning strikes a lightning rod in the tube. This effect is used to stabilize plasma in fusion reactors, and NASA has great expectations for it.

The economic aspect is always slowing the development of classic rocket engines: it is necessary to burn thousands of tons of fuel to transport only dozens of tons of payload. NASA sees a solution to this problem in the use of fusion engines as, besides their relatively low fuel consumption, they provide multiple capacity increase. The basic idea of this engine is following: in a parabolic combustion chamber the two components of fuel (deuterium and Li₆) are mixed; and a powerful electric pulse from capacitor turns them into plasma. The magnetic field of a large magnitude compresses the plasma and fusion reaction is ignited. The result is expanding plasma, which has a total weight of 0.02 kg, but its initial kinetic energy reaches 1 GJ. Then it is compressed by Z-pinch effect and ejected from the magnetic nozzle, creating reactive thrust.

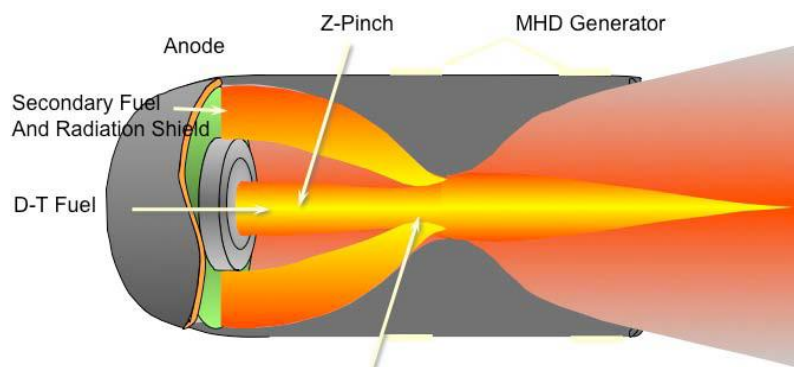

Figure 4: The engine on the Z-pinch effect

The main function of Z-pinch effect is to protect the engine from damage and to send a very large current through the dense plasma in a very short time (about 6.10 seconds).

The output is the reactive thrust of 3812 newton - seconds per pulse at the frequency of 10 pulses per second and the specific impulse of 19,436 seconds.

The engine is cooled with the liquid of fluorine - lithium- beryllium (FLiBe), which is also able to absorb gamma rays and neutrons. [8]

CONCLUSION

This article contains a review of the solution to the problem of inefficiency of liquid rocket engines for interplanetary missions. The use of atomic installations as engines for spacecraft was found as the most appropriate solution. The article gives a comparative analysis of the most interesting developments in this sphere under the authorship of scientists from the two major space powers - Russia and the United States. Two stages of formation of the NRE are considered. On the basis of the material studied it may be concluded that the interest in the NRE is increasing due to its perspective technologies in terms of capacity and efficiency. But it is necessary to mention the factors affecting adversely its development. First of all, it is the fear of radiation threat to the society: there are international rules prohibiting the use of the NRE at the altitudes less than 800 m above the surface of the Earth. Secondly, it is the fact that most NRE developments are only under conceptual design and scientists have to solve many problems before creating a real model of this engine.

REFERNCES

1. Andrey Suvorov (January 2007). TO MARS ON REACTOR: EXPLOSIVE POWER. Retrieved March 23, 2014, from <http://www.popmech.ru/article/1141-k-marsu-na-reaktore/>
2. A. Horoshih (24.03.2007). Project «Orion». Retrieved March 23, 2014, from <http://imperus.clan.su/publ/2-1-0-7>
3. Solid-phase nuclear jet. Retrieved March 23, 2014, from http://traditio-ru.org/wiki/Твёрдофазный_ядерный_реактивный_двигатель
4. Construction of nuclear energy and power and propulsion for space purposes. Retrieved March 23, 2014, from http://www.nikiet.ru/index.php?option=com_content&view=article&id=245%3Aspace-creation&catid=3&Itemid=50
5. Aleksander Emelianenko (03.10.2012) Tugboat in weightlessness. Retrieved March 23, 2014, from <http://www.rg.ru/2012/10/03/raketa.html>

6. I. Afanasyev (6.12.2012) Development of nuclear tug continues. Retrieved March 23, 2014, from <http://novosti-kosmonavтики.ru/mag/2013/1099/14567/>
7. Annual Report "ROCKET AND SPACE CORPORATION« ENERGIA » (2012)
8. J. Miernik, G. Statham, ERC Inc; L. Fabisinski, ISS Inc; C. D. Maples. FUSION PROPULSION Z-PINCH ENGINE CONCEPT

POLARIZING RADIATION FROM TARGETS WITH FINITE SIZES

D.B. Kalitvintsev

Scientific Supervisor: Post-graduate student A.S. Konkov

Language advisor: Teacher Ya.V. Ermakova

Tomsk Polytechnic University, Russia, Tomsk, Lenin str., 30, 634050

E-mail: Solieri@Sibmail.com

In the present report models of generation of the diffractive and Cherenkov radiation under a overflight of a charged particle around a rectangular shield and a triangular prism with arbitrary conductivity are submitted. In the process of researching different types of relations of geometric and macroscopic features of target and polarizing radiation were identified – such as dependents of intensity of radiation from depth of the shield, from value of dielectric permeability, from the value of impact-parameter, etc. The method of surface currents was used to make a mathematical model of the process of generation of the polarizing radiation.

Key words: polarizing radiation, Vavilov-Cherenkov radiation, diffraction radiation.

Research field: classical electrodynamics.

Related sciences: nuclear physics, physics of elementary particles.

INTRODUCTION

Nowadays theory of the emission of charged particles is not only dynamically developing field of the theoretical physics, but also it has multiple practical applications in the accelerator physics, plasma physics, the ultra-high frequency electronics. For example, since the 90s of the last century interest to transition radiation (TR) and diffraction radiation (DR) has grown significantly, because this radiation can be used in methods of weak-perturbing diagnostics of low-emittance beams in accelerators. This interest is primarily conditioned by the fact, that losses of energy of a particle with TR and DR are negligibly small versus the full energy of the particle [1]. In fact, these types of radiation represent different forms of polarizing radiation (PR), which have physical reason in dynamic polarization of atoms of the media by charged particle. In this case it is usually talked about the radiation of uniformly and rectilinearly moving charge (as well as in case of Vavilov-Cherenkov radiation), and both particle and excited atoms of the media can be called as source of radiation, since either of components is necessary for emergence of the radiation.

Polarizing radiation is a name for radiation that appears when moving charged particles interact with a condensed surroundings. Every charged particle creates around itself a spherically symmetric electric field. When it moves with a relativistic velocity, field will be deformed by the reason of the Lorenz-effect (reduction of a length in the direction of movement and enlargement a length in other directions) [2]. Flying near any atomic structure, particle will interact with electrons from outer energy levels by its field. As a result of this interplay, displacement of orbits of electrons occurs. Atom becomes polarized. Electronic shell will try to back in the normal condition and start to hover. These oscillations are cause for emission of polarizing radiation.

There are some types of PR: Vavilov-Cherenkov radiation (ChR), transition radiation, diffraction radiation and Smith-Purcell radiation (SPR).

The aim of this work is to research the properties of the polarizing radiation, which is generated by a charged particle provided flight near the rectangular screen or triangle prism with finite sizes, depending on geometric and macroscopic parameters of the target.

Objectives: look for theoretical approach of polarizing radiation, learn about the method of surface currents, build a mathematical model of process of polarizing radiation, test it for some special cases.

METHODOLOGY [6]

For mathematical modeling of process of the PR method of surface currents were used.

The surface current method is known in the theory of electromagnetic waves diffraction and it has been generalized to be applied to the problems of diffraction radiation generated by a charged particle moving nearby a screen in vacuum.

The exact macroscopic theory of plane waves diffraction is based on the use of the well-known integral equation for the surface current density induced by an incident field. In the last case the incident field satisfies the inhomogeneous Maxwell's equations. This rather unexpected fact may be explained taking into account the derivation of the integral equation using the so-called double-current layer formulation. On the other hand, this formulation allows finding the new integral equations determining a surface current density in the case when the incident field is not a plane wave. Solutions of these generalized equations allow to find the surface current density, and therefore to find an exact solution of a problem.

Physically, when a field (no matter what its nature) falls on a screen with unit normal \mathbf{n} it induces a dipole moment resulting in appearance of an additional field. In other words, the scattered wave may be represented as a field of the surface current formed by the dipoles distributed on a screen. Such representation corresponds to the ordinary dipole approximation in the microscopic theory of polarizing radiation. The surface distribution of electric dipole moment is known as a double sheet (layer), which is a surface where the density of surface charges $\rho_e \propto \mathbf{n} \cdot \mathbf{E}$ changes its sign but preserves its absolute value. The corresponding Maxwell's equations for the double surface current density may be written as:

$$\mathbf{E}(\mathbf{r}, \omega) = \frac{ic}{\omega} (\text{grad}(\text{div} + \frac{\omega^2}{c^2}))\mathbf{A}, \quad \mathbf{H}(\mathbf{r}, \omega) = \text{rot}\mathbf{A},$$

$$\mathbf{A} = \frac{1}{c} \int \mathbf{j}_s^e(\mathbf{r}', \omega) \frac{e^{i\omega|\mathbf{r}-\mathbf{r}'|/c}}{|\mathbf{r}-\mathbf{r}'|} dS', \quad \mathbf{j}_s^e = \frac{c}{2\pi} \mathbf{n} \times \mathbf{H},$$

where the dependence of current in the right-hand side upon the field in the left-hand side makes them integral equations for fields.

There also another method may be used, where a sign of the surface electric charges does not change when crossing the screen, but a sign of magnetic charges $\rho_m \propto \mathbf{n} \cdot \mathbf{H}$ changes. This representation leads to the dual Maxwell's equations for the double magnetic surface current density:

$$\mathbf{H}(\mathbf{r}, \omega) = \frac{ic}{\omega} (\text{grad}(\text{div} + \frac{\omega^2}{c^2}))\tilde{\mathbf{A}}, \quad \mathbf{E}(\mathbf{r}, \omega) = -\text{rot}\tilde{\mathbf{A}},$$

$$\tilde{\mathbf{A}} = \frac{1}{c} \int \mathbf{j}_s^m(\mathbf{r}', \omega) \frac{e^{i\omega|\mathbf{r}-\mathbf{r}'|/c}}{|\mathbf{r}-\mathbf{r}'|} dS', \quad \mathbf{j}_s^m = -\frac{c}{2\pi} \mathbf{n} \times \mathbf{E},$$

and corresponds to a double magnetic sheet, where the “current density” (axial vector) \mathbf{j}_s^m is formed by magnetic dipoles. The problem of a plane wave diffraction on a screen with permittivity $\varepsilon = \infty$ is known to be equivalent to the problem of diffraction on a complementary screen with $\mu = \infty$.

The fields in the right-hand sides of the last equals consist of the incident fields \mathbf{H}_i , \mathbf{E}_i and the scattered ones \mathbf{H}_s , \mathbf{E}_s , while the fields in the left-hand side are commonly observed at the far distances where only the scattered field has place (wave zone). Substituting the expression for magnetic field in the surface current, it is possible to write down the ordinary Fock’s integral equation for the current density:

$$\mathbf{j}_s^e(\mathbf{r}', \omega) = \frac{c}{2\pi} \mathbf{n} \times \mathbf{H}_i - \frac{1}{2\pi} \mathbf{n} \times \int \mathbf{j}_s^e(\mathbf{r}'', \omega) \times \text{grad} \frac{e^{i\omega|\mathbf{r}-\mathbf{r}''|/c}}{|\mathbf{r}-\mathbf{r}''|} dS''.$$

DEVELOPMENT

Schemes of generation PR in the case of screen (Fig. 2) and prism (Fig. 3) are shown.

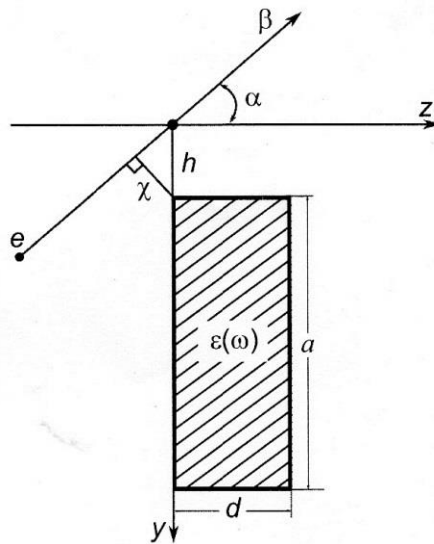

Fig. 2. Scheme of generation of PR from the screen

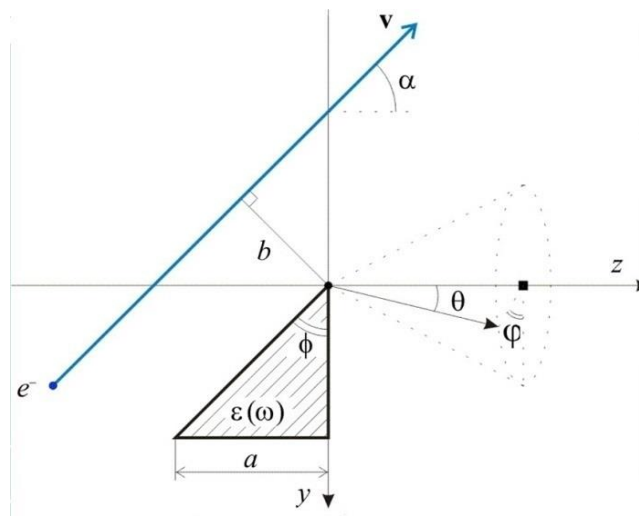
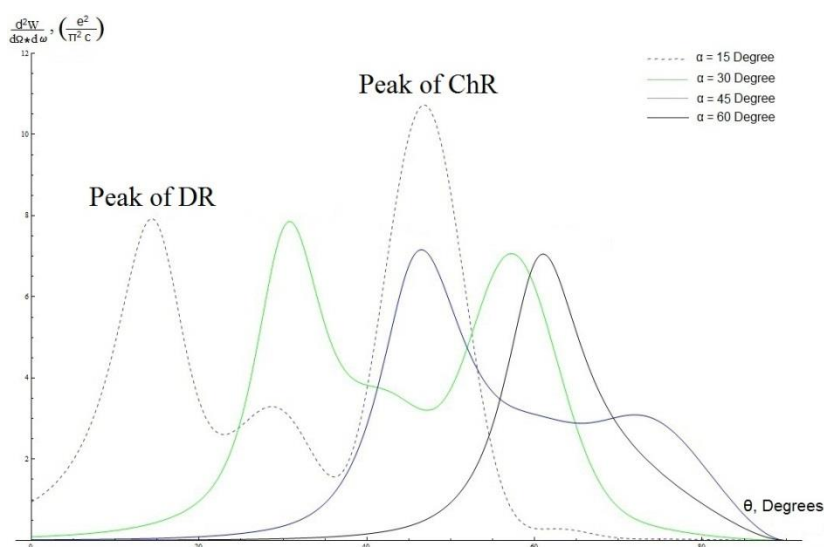

Fig. 3. Scheme of generation of PR from the prism

Where χ (or b) – impact-parameter (the shortest distance between the edge of the target and trajectory of the particle); h – distance from the origin to the target; γ – Lorenz-factor; v – velocity of the particle; c – speed of light in vacuum; β – relative velocity of particle; d – depth of the target; a – length of the target; θ – polar angle, α – angle of flight of the particle; φ – azimuth angle; $\varepsilon = \varepsilon' + i\varepsilon''$ – permittivity of the media (target); ω – frequency of the polarizing radiation, λ – wavelenght of the polarizing radiation, ϕ – angle of disclosure of the prism.

As example, the dependence between spectral-angular density of PR from the polar angle over the different angles of flying is descried.



Parameters: $c = 3 \cdot 10^8 \text{ mps}$; $\gamma = 10$; $\varepsilon = 1.5 + 0 \cdot i$; $\chi = 10^{-3} \text{ m}$; $d = 10^{-2} \text{ m}$; $a = 0.005 \text{ m}$; $\phi = 180^\circ$; $\lambda = 0.001 \text{ m}$.

Fig. 4. Dependence between spectral-angular density of PR from the polar angle over the different angles of flying

As we can see, under the low angles of fall intensity of DR is small, ChR makes primary contribution. When the angle α grows, peak of the ChR replaces in the side of bigger polar angles and, at the same time, its intensity descends, and, when $\alpha = 60^\circ$, only DR makes the principal contribution.

The peak of DR behaves similar way, i.e. it moves in the region of bigger polar angles θ , but decrease of intensity of this radiation goes more smoothly.

RESULTS

In the present paper models of generation of the TR and DR are presented in the case of flying of charged particle near the rectangular screen and triangular prism with an arbitrary conductivity. These models can be used for the solution of problems of generation THz-radiation with short relativistic electron clots and for elaboration of the new methods of diagnostic of charged particle beams by the modern accelerators.

In the process of researching some dependences has been found, that correspond to the relations between

characteristics of DR, which is excited by relativistic particle over the flying near screen and prism, and thickness of the screen, the dielectric permittivity, the impact-parameter. In the case of zero width of the slot results fully coincide with the respective results from the theory of TR for plate with arbitrary values of permittivity and angle of the fall were obtained. Obtained equations for the spectral-angular density of radiation in the backwards direction explain not only mechanism of DR, but also Vavilov-Cherenkov radiation.

Thus, dependencies of the main properties of different types of polarizing radiation (DR, TR, ChR, other) from geometric, macroscopic characteristics of the target, from the parameters of the particles, that cause present radiation, has been determined.

CONCLUSION

It is clear, therefore, that area of application of polarizing radiation significantly has enlarged nowadays. Theories about fundamental structure and variable effect of emitting are successfully constructed, technological progress opens new horizons for researching and using polarizing radiation.

The most popular direction in the modern physics is elementary particles. They are analyzed and dissected in the colliders, and the DR helps to diagnose beams of particles and make courageous experiments possible. Transition radiation is used in such important method of science as microscopy.

REFERENCES

1. Тыапкин, А.А. (2001) Microscopic nature underlying Vavilov-Cherenkov effect. *Physics of atomic nucleus and elementary particles*, 32 (4), 946 – 963.
2. Landau, L.D., Lifshitz, E.M. *Theoretical physics, vol. 8: Electrodynamics of Continuous Media: Handbook* (Nauka, Moscow, 1982), p.211.
3. Jelly, J.V. (1956) Cherenkov Radiation. *UFN*, 58 (2), 232 – 283.
4. Bolotovskiy, B.M., Galstyan, E.A. (2000) Diffraction and diffraction radiation. *UFN*, 170 (8), 809 – 830.
5. Karlovets, D.V., Potylitsyn, A.P. (2008) On the theory of diffraction radiation. *JETP*, 134 (5), 887 – 901.
6. Karlovets, D.V., Potylitsyn, A.P. (2009) Generalized surface current method in the macroscopic theory of diffraction radiation. *Physics Letters A*, 373, 1988-1996.
7. Jackson, J.D. *Classical electrodynamics: Handbook* (John Wiley & Sons, Inc., New York – London, 1962), p.130.

FUNDAMENTALS AND APPLICATION OF MICROTOMOGRAPHY

C.V. Keltcieva

Scientific Supervisor: Research I.E. Fotina

Linguistic Advisor: Teacher Y.V. Yermakova

Tomsk Polytechnic University, Russia, Tomsk, Lenin str., 30, 634050

E-mail: christi46@yandex.ru

Abstract

The word «tomography» can be translated from the Greek as «slice of image». This means that the appointment of tomography is obtaining cross-sectional images of the internal structure of the object of the study.

Attenuation - reduction in the intensity of X-rays passing through matter, the degree of attenuation is expressed quantitatively by the linear attenuation coefficient;

Detector – tomography component measuring the intensity of the incident X-rays. Usually scanners equipped with solid-state detectors or ionization chambers, effectively absorbing X-rays;

Geometry scanner - layout of X-ray tube and the detector relative to the axis of rotation;

Linear attenuation coefficient - x-ray attenuation coefficient;

Pixel – picture element;

Projection angle - the angle at which resides Source X-ray attenuation in the measurement of the profile;

Reconstruction image - calculation of image projection data;

X-ray tube - X-ray source used almost in all scanners. Consists of an anode and a cathode, placed in a vacuum chamber. The spectrum of the intensity of the generated radiation depends on the applied voltage and current to anode and to cathode, which is generated due to the fact that the electrodes leave the cathode and fall to the surface of the anode.

Introduction

Types of tomography:

1. Anatomical imaging , breaking tomography - is based on the physical implementation of sections of the test organism with subsequent fixation by chemicals , with further recording them on film . Classic examples are the Pirogov anatomical imaging slices and images of histological preparations. To maintain the shape of the body when the slicing, body is fixed, for example, by freezing.

2. Reconstructive tomography, noninvasive imaging - getting one way or another about the distribution parameter of interest in higher-dimensional object from its projections of lower dimension without destroying the object; antonym of anatomical imaging. In the scope of the concept includes computing and analog reconstructive tomography.

3. Analog reconstructive tomography - reconstructive tomography, which uses analog computing devices to restore the distribution parameter object.[2]

Computed tomography (CT) is a non-destructive technique that provides three-dimensional images of the internal structure of an object. The basic idea of this imaging technique goes back to J. Radon, who proved in 1917 that an n-dimensional object can be reconstructed from its (n-1)-dimensional projections. The possibility of

non-invasively imaging three-dimensional sections of a human body was of such importance that Cormack and Hounsfield were awarded with the Nobel Prize for Medicine in 1979.[3]

Micro computed tomography is X-ray imaging in 3D, by the same method used in hospital CT scans, but on a small scale with massively increased resolution. It really represents 3D microscopy, where very fine scale internal structure of objects is imaged non-destructively.

Classification of tomography:

From the viewpoint of relative position of the probe radiation source, object and detector, tomographic techniques may be divided into the following groups:

- Transmission - recorded probing external radiation passing through the passive (nonradiative) to partially weakening (the shadow of the object);
- emission - recorded radiation from active (radiative) object with a certain spatial distribution of radiation sources ;
- combined transmission-emission - recorded from secondary radiation sources distributed over the volume of the object and excited by external radiation ;
- ehoprobing - probing external radiation is recorded, which is reflected from the internal structures of the passive object.

Dimensions of the objects:

- Micro level (microtomography) - objects the size of a single cell is studied.
- Object level commensurate with the human body (as a separate body or laboratory mouse to the aircraft).
- Macro level - atmospheric phenomena, planets, stars.[2]

The MicroCT Technique

The basic physical principal of computed tomography is the interaction of ionizing radiation, such as X-ray with matter, where, in the energy range typically used for CT imaging, the so-called photo-effect builds the main interaction mechanism. The photo-effect attenuates the photons proportional to the third power of the order number of the elements and inverse proportional to the third power of the photon energy. Thus, the actual attenuation not only depends on the material but also on the energy spectrum of the X-ray source. As an X-ray beam penetrates an object, it is exponentially attenuated according to the material along its path. The energy-dependent material constant appearing in the exponent of this attenuation formula is called the linear attenuation coefficient. It expresses the amount of radiation that is attenuated on an infinitely small distance, in which the final attenuation reflects the sum of all these local linear attenuations along the X-ray beam. Therefore, an X-ray projection (or X-ray image) represents an image of the sum of all local attenuations along the X-ray beam.

To produce a three-dimensional CT image, a whole set of such two-dimensional projections need to be acquired. In microCT, these projections are usually taken in a setup in which the source and detector are at a fixed position and the object is rotated around its long axis (Figure 1). The source is mostly either a microfocus X-ray tube or an insertion device of a synchrotron radiation facility and the detector is normally based on a CCD camera with a phosphor layer to convert X-ray to visible light. Since CCD cameras have a limited number of pixels, the projections are recorded in discrete points with a so-called sampling distance (distance between

neighboring pixels) and a maximal number of samples (which may correspond to the number of pixels on the CCD). It can be shown that the number of projections taken over 180 degrees should be about twice the number of samples per projection to avoid aliasing artifacts. The two-dimensional projections can then be used to reconstruct a three-dimensional image. In this sense, CT images can be seen as images that represent linear attenuation coefficients.[3]

CT provides high contrast because each pixel is assigned the value of the attenuation coefficient corresponding to one volume element, the image contrast is defined as the difference between the attenuation coefficients of two adjacent elements or areas of the image.

According to the Radon theory to obtain acceptable image quality, it is necessary to measure a sufficiently large number of integrated attenuation values (projections). These measurements must be made in all directions at least to the range angular from 0^0 to 180^0 , where in each projection is necessary to obtain a plurality of data points with a short interval.[4]

For a more detailed consideration of options computed tomography is a block of cedar wood, which is seen in the 3D image (figure 2) and cross-sectional image (figure 3).

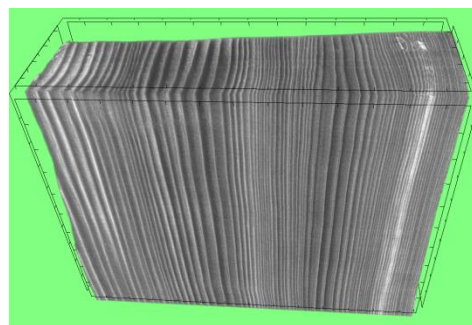
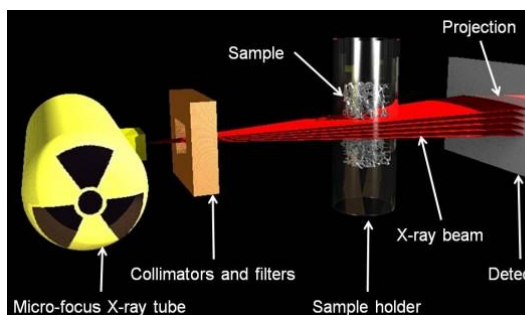

Figure 1: Main components and working principle of a microCT scanner. A micro-focus X-ray tube emits X-ray, which is collimated and filtered to narrow the energy spectrum. The X-ray passes then the object and is recorded by a two-dimensional CCD array. A full scan involves a set of projections under different rotations of the object.

Figure 2: A block of wood in 3D image.

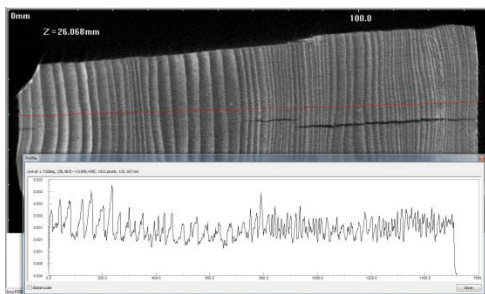

Figure 3: Wooden block sectional, plot of the intensity of the length of the bar on the red line.

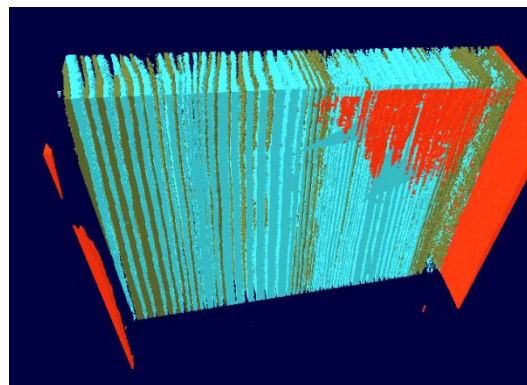

Figure 4: Wooden bar, which by means of the color gamut is distributed on different density equal. Red highlighted the minimum density that this case indicates air in green denotes the average density, blue - high density material.

Algorithms for Reconstruction with Nondiffracting Sources

A line integral, as the name implies, represents the integral of some parameter of the object along a line. There is a typical example is the attenuation of x-rays as they propagate through biological tissue. In this case the object is modeled as a two-dimensional (or three-dimensional) distribution of the x-ray attenuation constant and a line integral represents the total attenuation suffered by a beam of x-rays as it travels in a straight line through the object.

We will use the coordinate system defined in Fig. 3.1 to describe line integrals and projections. In this example the object is represented by a 2D function $f(x, y)$ and each line integral by the (θ, t) parameters.

The equation of line AB in Fig. 5 is

$$x \cdot \cos\theta + y \cdot \sin\theta = t \quad (1)$$

and we will use this relationship to define line integral $P_\theta(t)$ as

$$P_\theta(t) = \int_{(\theta,t)line} f(x, y) ds \quad (2)$$

Using a delta function, this can be rewritten as

$$P_\theta(t) = \int_{-\infty}^{\infty} \int_{-\infty}^{\infty} f(x, y) \delta(x \cdot \cos\theta + y \cdot \sin\theta - t) dx dy \quad (3)$$

The function $P_\theta(t)$ is known as the Radon transform of the function $f(x, y)$.

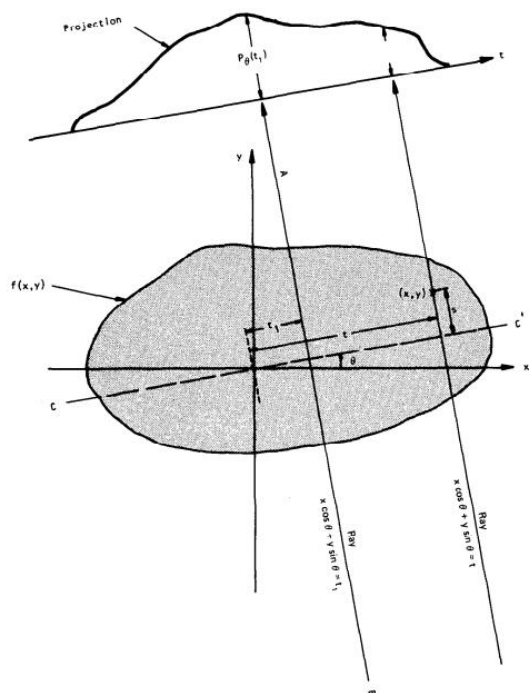

Figure 5: An object, $f(x,y)$, and its projection, $P_{\theta}(t_1)$, are shown for an angle of θ .

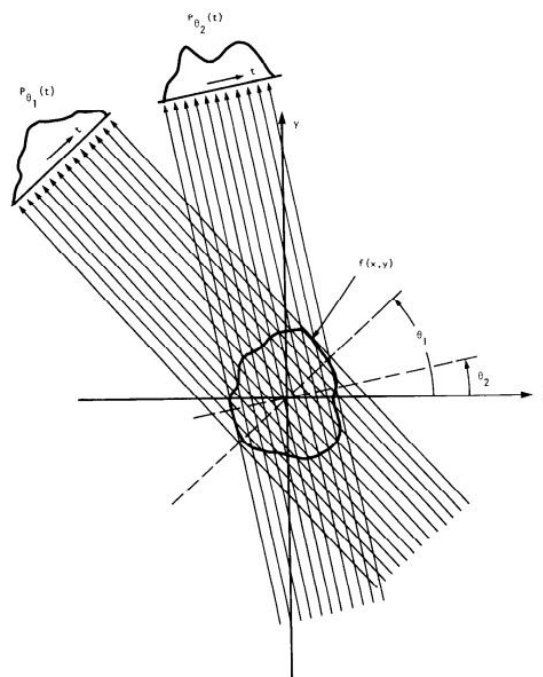

Figure 6: Parallel projections are taken by measuring a set of parallel rays for a number of different angles.

A projection is formed by combining a set of line integrals. The simplest projection is a collection of parallel ray integrals as is given by $PO(t)$ for a constant θ . This is known as a parallel projection and is shown in Fig. 3.2. It could be measured, for example, by moving an x-ray source and detector along parallel lines on opposite sides of an object. [5]

Typical use

- Biomedical
- Electronics
- Microdevices
- Composite materials and metallic foams
- Polymers, plastics
- Diamonds
- Food and seeds
- 3-D imaging of foods using X-ray microtomography
- Wood and paper
- Building materials
- Geology
- porosity and flow studies
- Microfossils
- Space
- Stereo images

Conclusion

As a non-invasive method and by allowing to obtain data with a resolution of tens of nanometers to millimeters, microtomography becomes a breakthrough method for studying the structure and can significantly extend existing views and research in many fields of science and industry. The results of the study of various objects and materials as may be additional data to existing laboratory, and supplier of modern, not previously available information.[6]

References

1. Рентгеновская трубка from http://www.medical-enc.ru/16/x-ray_tube.shtml
2. Левин Г.Г. Курс компьютерной томографии from <http://bourabai.kz/cm/tomography.htm>
3. Micro-Computed Tomography from http://www.b-cube.ch/index.php?option=com_content&view=article&id=21&Itemid=19
4. Календер, В. (2006) Компьютерная томография. Основы, техника, качество изображений и области клинического использования. Москва: Техносфера, 2006.-334с. ISBN
5. A. C. Kak and Malcolm Slaney, *Principles of Computerized Tomographic Imaging*, Society of Industrial and Applied Mathematics, 2001 from <http://www.slaney.org/pct/pct-toc.html>
6. Практическая микротомография from <http://www.agora.guru.ru/display.php?conf=microCT>

STUDY OF THE DEFECT STRUCTURE'S EVOLUTION OF THE TITANIUM ALLOY VT1-0 AFTER THERMOHYDROGEN CYCLING BY POSITRON ANNIHILATION SPECTROSCOPY

O.V. Khusaeva, U.S. Bordulev, V.N. Kudiyarov

Scientific Supervisor: Assistant R.S. Laptev

Linguistic advisor: Senior teacher N.V. Demyanenko

Tomsk Polytechnic University, Russia, Tomsk, Lenin str., 30, 634050

E-mail: Khusaeva852@mail.ru

Changes of the defect structure in titanium alloy after thermohydrogen cycling were studied by means of positron lifetime spectrometry and Doppler broadening spectrometry.

Titanium and its alloys having properties such as light weight, high specific strength, fracture toughness, corrosion resistance, have been widely used as a structural material. Using of materials in the chemical, nuclear, oil and gas industry, as well as the aviation industry is accompanied by interaction of materials with hydrogen. Under the influence of hydrogen take place the significant changes of the physical and mechanical properties of the metal and its alloys, which lead them to embrittlement and destruction [1,2].

The high-temperature annealing in a vacuum is the most reliable method for the extraction of hydrogen from the metal but the impact of this treatment (accumulation of hydrogen - thermal annealing) on the defect structure of titanium alloys is still open.

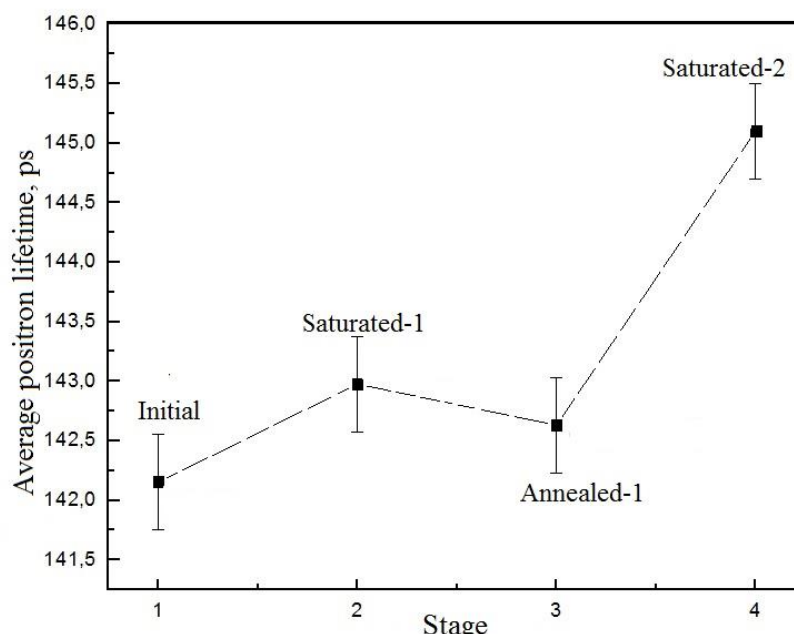

– the result obtained with [18]) Fig. 2. The spatial distribution of energy release power density across the focused ion beam (10 keV Ar⁺ ion beam with the diameter of 50 nm is incident on Al-target) Figure 1.-

The purpose of this work is the studying of Defect structure's evolution of the titanium alloy VT1-0 after thermohydrogen cycling. As the methods of research we used methods of electron-positron annihilation (EPA), which have high sensitivity to determine the concentration and type of defects. Also the positron is the unique

probe to study the behavior of the proton in hydrogen-absorbing matters, for both particles has the same positive elementary charge. In perfect crystals, positrons delocalize in interstitial sites and annihilate with electrons there, since positrons are strongly repelled by ion cores due to Coulomb repulsion, as well as protons. Then, positron annihilation characteristics are determined by the local electronic structure at the interstitial sites, where protons also stay stable [3].

For research we used rectangular flat samples of titanium alloy VT1- 0 with dimensions of $20 \times 20 \times 1$ mm. Samples were mechanically ground, polished and annealed at 750°C for 60 minutes followed by slow cooling to room temperature in vacuum. The hydrogen saturation was conducted by the method of Siverst to 0.05 wt. % at 500°C at a pressure of 0.66 atm. Annealing and hydrogenation were carried out on the installation Gas Reaction Controller [4]. After every processing stage the samples were measured for positron lifetime and the Doppler shift of the annihilation line. [5]

The positron lifetime was measured with a spectrometer, described in detail in [5]. The essence of the method is shown in Fig. 3 and is based on measuring time interval between two events: birth and annihilation of the positron. For measurement of positron lifetime usually used the β^+ -source which also radiate secondary γ -quantum simultaneously with positron. This γ -quantum is a start signal on the timeline and it witnesses the birth of the positron. Stop signal is one of the two annihilation γ -quanta with energies of 511 keV. Relatively low activity sources of positrons allows to distinguish the Start and Stop pulses corresponding to one positron, because it is assumed that at each time point in the material is no more than one positrons.

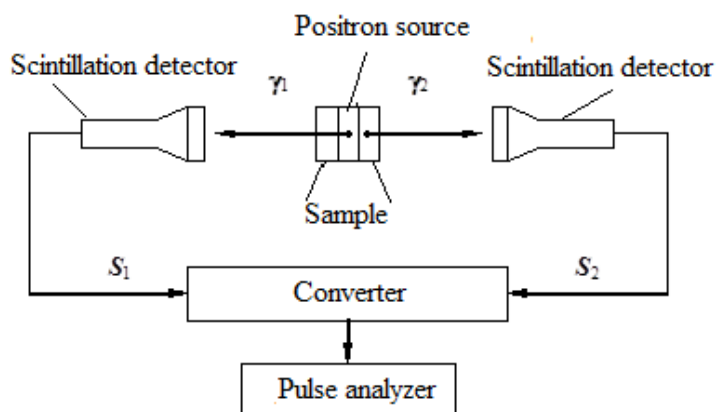

Figure 3.- The measuring principle of the positron lifetime in the material.

Fig. 1 shows the dependence of the average lifetime of positrons from processing stage. The graph shows that the value of the average lifetime of positrons is practically unchanged after first hydrogenation and subsequent annealing. However, a sharp increase in the value of the average lifetime of positrons to $145,5 \pm 0,4$ ps is observed after re-hydrogenation. Average positron lifetime characterizes the cumulative impact of different types of defects on the electronic density of the material. More information about the defects after every processing stage gives multicomponent decomposition of the time spectrum.

Table 1.

Values of the two-component decomposition of time distribution

Processing stages			Positron lifetime components, ps		Intensity of components, %
			τ_1	τ_2	I_2
Initial			142,2	–	–
Saturated-1			142,8	301,8	0,10
Annealed-1			142,6	–	–
Saturated-2	144,4	656,6	0,16		

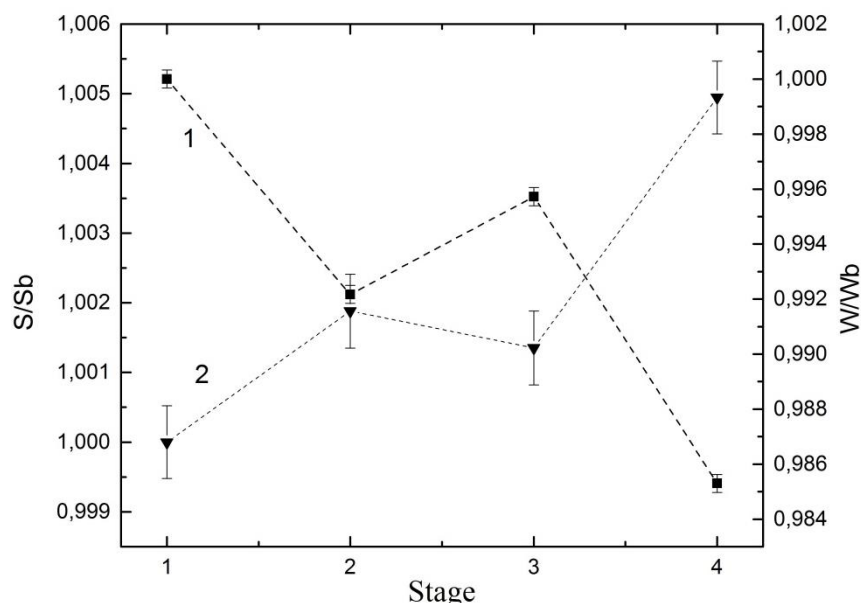

Figure 2. - Dependence S/Sb and W/Wb DUAL shape parameters from the processing stages. 1 - relative parameter S/Sb ; 2 relative parameter W/Wb .

The components and their intensities allow obtaining the qualitative and quantitative information about the type of defects and their concentration. For analyses we used two time components: short-lived component τ_1 and the long-lived component τ_2 and the corresponding intensities I_1 and I_2 . Component τ_1 is associated with the annihilation of positrons from the delocalized state in the lattice of the metal, and long-lived component τ_2 corresponds to the annihilation of positrons from a localized state in the vicinity of defects metal. Table 1 shows the results of the time spectra's processing. Hydrogenation leads to the appearance in the time spectra of long-lived component with a lifetime 301.8 ps, this value is much greater than the value of the positron lifetime in a single vacancy $\tau_{vac} = 220$ ps and corresponds to the annihilation of positrons trapped vacancy clusters consisting of four single vacancies [6]. After the second cycle of hydrogenation observed a significant increase of long-lived component, its value reaches 656.6 ps, which is probably due to the formation of micropores. Compared to the first cycle of hydrogenation the intensity of the component does not increase significantly.

Conservation of momentum during the annihilation process is the reason for the fact that the annihilation radiation contains information on the electron momentum distribution at the annihilation site. This can be used for the study of the electron structure in solids and for the investigation of defects.

In the analysis of Doppler broadening spectra of annihilation line the shape parameters S and W are used. S

parameter is defined in the low-energy and characterizes the probability of positron annihilation with the valence electrons. W parameter is defined in the field of high energy and characterizes the probability of positron annihilation with the core electrons [7]. For analysis S and W are commonly normalized to the values for a defect-free material S_b and W_b respectively. This approach allows more contrastly compare test samples with respect to the initial (zero-defect) sample.

Fig. 2 shows the dependence of relative parameters S/S_b and W/W_b of processing steps, and where S_b and W_b parameters of the original sample. The graph shows that when the sample is saturated with hydrogen the parameter S/S_b increases and W/W_b decreases. These changes of the annihilation characteristics are due to the formation of vacancy clusters. After annealing, one observed a decrease of the S_b parameter and an increase of the W parameter, which indicates the reduction of the number of defects in the sample. At this stage, it is seen that the defective structure of sample does not return to the initial state. Re-saturation causes a significant rise of the S parameter and drop of W parameter that corresponds to a sharp increase of number and sizes of defects in the sample. These results are in good agreement with the results of analysis by spectrometry average positron lifetime.

In the course of this work there was a study of the defect structure changes of titanium alloy VT1-0 for thermohydrogen cycling by EPA methods. The results analysis over spectrometry of positrons of average lifetime and Doppler broadening of the annihilation line showed that at saturation of titanium with hydrogen to 0.05 wt.%, the defects appear in the sample: after the first of hydrogenation the vacancy clusters are formed, which consist of four single vacancies, after the second cycle the micropores appear.

REFERENCES

1. Chernov I.P. Methods of study metal-hydrogen systems. - Tomsk; Energoatomizdat 2004. – 269.
2. Mukhashev, BA Tronin . Defects origin hydrogen in alloys of refractory metals and annihilation of positrons / / Proceedings of the universities . Physics. - 2012 - № 1/3 - p.119 -125.
3. Y. Shirai, H. Araki, T. Mori, W. Nakamura, K. Sakaki. Positron annihilation study of lattice defects induced by hydrogen absorption in some hydrogen storage materials. Journal of Alloys and Compounds 330–332 (2002) 125–131.
- 4 .Kudiyarov VN Leader AM Study of the processes of adsorption and desorption of hydrogen by means of automated complex gas reaction controller LP // Fundamental research. - 2013 - №. 10-15. - C. 3466-3471
- 5 . Bordulev S. Laptev RS positron lifetime spectrometer // Modern equipment and technology: Proceedings of the XIX International Scientific and Practical Conference of Students and Young Scientists: 3 tons, Tomsk , 15-19 April 2013 . - Tomsk Polytechnic University, 2013 - Volume 1 - C. 131-132.
- 6 . J. Čížek, O. Melikhova, Z. Barnovská, I. Procházka and RK Islamgaliev. Vacancy clusters in ultra fine grained metals prepared by severe plastic deformation // J. Phys. Conf. Ser. 443 0120088 (2013)
7. R. Krause-Rehberg, and HS Leipner, Positron Annihilation in Semiconductors: Defect Studies, Springer, Berlin Heidelberg New York, 2003, Vol. 127.

MULTIGROUP METHOD FOR CALCULATING THE SPECTRUM OF THE NEUTRON FLUX DENSITY OF RBMK-1000

I.N. Kryvtsov, A.M. Mochalov

Scientific Supervisor: PhD, Associate professor V.N.Nesterov

Linguistic Advisor: Teacher Y.V. Ermakova

Tomsk Polytechnic University, Russia, Tomsk, Lenin str., 10

E-mail: kryptsov.ivan@gmail.com

The article describes a method for calculating the spectrum of the multigroup neutron flux. The paper shows the basic rules and principles of multigroup calculation, presented the basic formulas. Just article shows the calculated neutron spectrum RBMK-1000 using multigroup method. The calculation is performed within the job of teaching and research students TPU.

Multigroup diffusion equations system for critical nuclear reactor (stationary problem) has the following form [1, 2]:

$$D^{(i)} \Delta \Phi^{(i)} - \Sigma_a^{(i)} \Phi^{(i)} - \sum_{k=i+1}^{26} \Sigma_R^{i \rightarrow k} \Phi^{(i)} + \sum_{k=1}^{i-1} \Sigma_R^{k \rightarrow i} \Phi^{(k)} + \varepsilon^{(i)} \sum_{k=1}^{26} \nu_f^{(k)} \Sigma_f^{(k)} \Phi^{(k)} = 0 \quad (1)$$

where i - number of the group for which the equation is written; k - group number; $D^{(i)}$ - neutron diffusion coefficient of i -th group; $\Phi^{(i)}, \Phi^{(k)}$ - neutron flux density in the respective groups; $\Sigma_a^{(i)}$ - macroscopic neutron absorption cross section of i -th group; $\Sigma_R^{i \rightarrow k}, \Sigma_R^{k \rightarrow i}$ - macroscopic neutron cross section transition of the i -th in the lying below k -th (from lying above k -th in the considered i -th) group, respectively; $\varepsilon^{(i)}$ - the probability for fission neutron to have a direct access to the i -th group; $\nu_f^{(k)}$ - the average number of neutrons per fission; $\Sigma_f^{(k)}$ - macroscopic fission cross section for neutrons of k -th group.

According to the equation of the critical reactor in the diffusion-age approximation, the first term in the equation (1), which describes the neutron leakage from the core, will be determined by the relation:

$$D^{(i)} \Delta \Phi^{(i)} = -D^{(i)} B^2 \Phi^{(i)} \quad (2)$$

where B^2 - geometrical parameter.

To organize the iterative process when solving the system of equations in the problem a system of equations for determining the neutron flux density of the following form should be set up:

$$\Phi_j^{(i)} = f(\Phi_{j-1}^{(1)}, \Phi_{j-1}^{(2)}, \dots, \Phi_{j-1}^{(k)}, \dots, \Phi_{j-1}^{(26)}), \quad k \neq i$$

where j - number of iterations, starting with the first.

To this end, a system of multigroup diffusion equations using the relation (2) should be brought to the form:

$$-D^{(i)}B^2\Phi^{(i)} - \sum_a^{(i)}\Phi^{(i)} - \sum_{k=i+1}^{26}\Sigma_R^{i\rightarrow k}\Phi^{(i)} + \sum_{k=1}^{i-1}\Sigma_R^{k\rightarrow i}\Phi^{(k)} + \varepsilon^{(i)}\sum_{\substack{k=1 \\ k\neq i}}^{26}v_f^{(k)}\Sigma_f^{(k)}\Phi^{(k)} + \varepsilon^{(i)}v_f^{(i)}\Sigma_f^{(i)}\Phi^{(i)} = 0 \quad (3)$$

Expressing the flux density in the i-th group from (3) we obtain:

$$\Phi_j^{(i)} = \frac{\varepsilon^{(i)}\sum_{\substack{k=1 \\ k\neq i}}^{26}v_f^{(k)}\Sigma_f^{(k)}\Phi_{j-1}^{(k)} + \sum_{k=1}^{i-1}\Sigma_R^{k\rightarrow i}\Phi_j^{(k)}}{D^{(i)}B^2 + \Sigma_a^{(i)} + \sum_{k=i+1}^{26}\Sigma_R^{i\rightarrow k} - \varepsilon^{(i)}v_f^{(i)}\Sigma_f^{(i)}} \quad (4)$$

The system of equations is transformed to:

$$\left\{ \begin{array}{l} \Phi_j^{(1)} = \frac{\varepsilon^{(1)}\sum_{\substack{k=1 \\ k\neq i}}^{26}v_f^{(k)}\Sigma_f^{(k)}\Phi_{j-1}^{(k)}}{D^{(1)}B^2 + \Sigma_a^{(1)} + \sum_{k=2}^{26}\Sigma_R^{1\rightarrow k} - \varepsilon^{(1)}v_f^{(1)}\Sigma_f^{(1)}}; \\ \Phi_j^{(2)} = \frac{\varepsilon^{(2)}\sum_{\substack{k=1 \\ k\neq i}}^{26}v_f^{(k)}\Sigma_f^{(k)}\Phi_{j-1}^{(k)} + \Sigma_R^{1\rightarrow 2}\Phi_j^{(1)}}{D^{(2)}B^2 + \Sigma_a^{(2)} + \sum_{k=3}^{26}\Sigma_R^{2\rightarrow k} - \varepsilon^{(2)}v_f^{(2)}\Sigma_f^{(2)}}; \\ \Phi_j^{(3)} = \frac{\varepsilon^{(3)}\sum_{\substack{k=1 \\ k\neq i}}^{26}v_f^{(k)}\Sigma_f^{(k)}\Phi_{j-1}^{(k)} + \Sigma_R^{1\rightarrow 3}\Phi_j^{(1)} + \Sigma_R^{2\rightarrow 3}\Phi_j^{(2)}}{D^{(3)}B^2 + \Sigma_a^{(3)} + \sum_{k=4}^{26}\Sigma_R^{3\rightarrow k} - \varepsilon^{(3)}v_f^{(3)}\Sigma_f^{(3)}}; \\ \dots \\ \Phi_j^{(25)} = \frac{\sum_{k=1}^{24}\Sigma_R^{k\rightarrow 25}\Phi_j^{(k)}}{D^{(25)}B^2 + \Sigma_a^{(25)} + \Sigma_R^{25\rightarrow 26}}; \\ \Phi_j^{(26)} = \frac{\sum_{k=1}^{25}\Sigma_R^{k\rightarrow 26}\Phi_j^{(k)}}{D^{(26)}B^2 + \Sigma_a^{(26)}}. \end{array} \right.$$

In the present system of equations all options except the flux densities at the previous iteration $\Phi_{j-1}^{(k)}$ are known

and, consequently, $\sum_{\substack{k=1 \\ k\neq i}}^{26}v_f^{(k)}\Sigma_f^{(k)}\Phi_{j-1}^{(k)}$. This amount determines the number of neutrons produced in the second

generation during nuclear fission by all neutrons of the first-generation, except neutrons of the i-th group.

To start the iterative process at zero iteration neutron flux density in the i-th group was determined from the relation (1) with (2) using the following relationship:

$$\Phi_0^{(i)} = \frac{\varepsilon^{(i)} \sum_{k=1}^{26} \nu_f^{(k)} \Sigma_f^{(k)} \Phi^{(k)} + \sum_{k=1}^{i-1} \Sigma_R^{k \rightarrow i} \Phi_0^{(k)}}{D^{(i)} B^2 + \Sigma_a^{(i)} + \sum_{k=i+1}^{26} \Sigma_R^{i \rightarrow k}}$$

where the number of neutrons produced in the second generation during nuclear fission by all neutrons of the

first generation, was set equally to unity ($\sum_{k=1}^{26} \nu_f^{(k)} \Sigma_f^{(k)} \Phi^{(k)} = 1$).

Having determined the spectrum of the neutron flux at zero iteration, an iterative process using (4) was organized. The results of the 26-group calculation of the neutron spectrum in the RBMK-1000 reactor are shown in Figure 1.

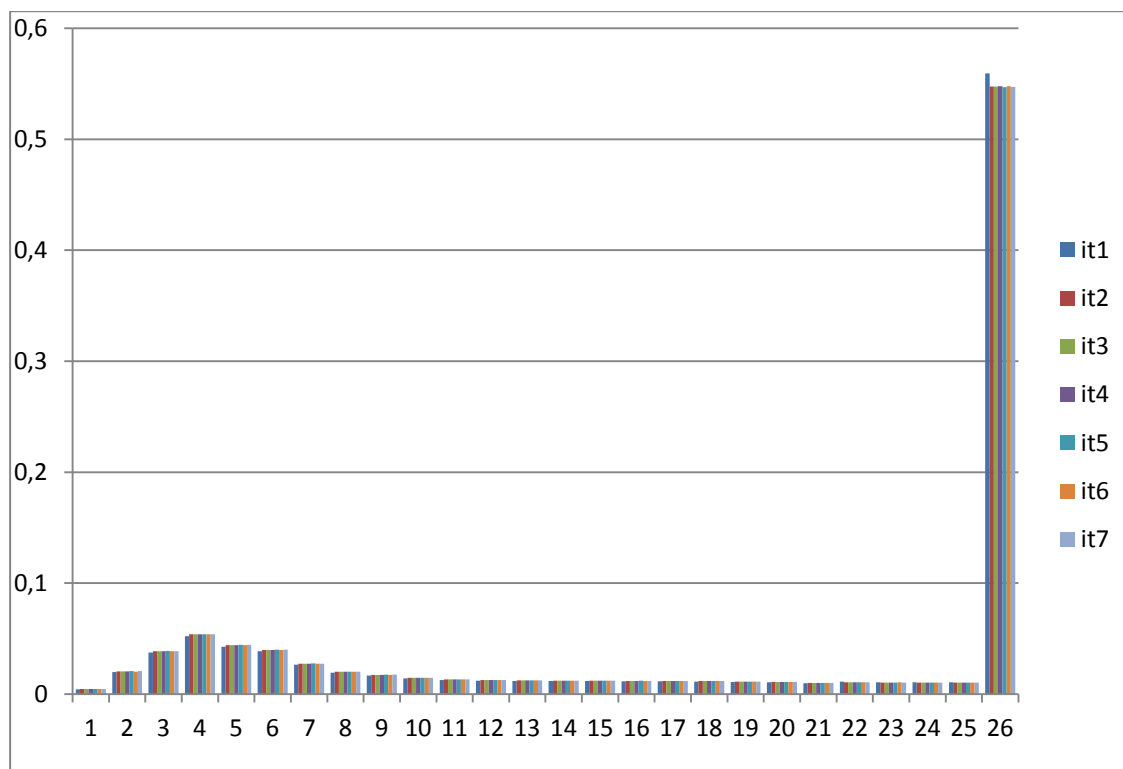

Figure 1. Range of 26 neutron groups in 7 iterations

REFERENCES

1. Golovatskiy A.V., Nesterov V.N., Shamanin I.V., Organization in iterative process of numerical reconstruction neutron spectrum in the multiplying system graphite-moderated. Journal of higher education institutions. Physics. 2004.
2. Kryvtsov I.N., Mochalov A.M., Multigroup method for calculating the spectrum of the neutron flux density of RBMK-1000. Educational and research work. 2013.

DEVELOPMENT OF PULSE OXIMETRY FOR APPLICATION IN MEDICINE

N.I. Martemyanova

Scientific Supervisor: PhD A.N. Aleinik

Linguistic Advisor: Senior teacher N.V. Demyanenko

TPU, Lenina, 30

raindrops-on-the-river@yandex.ru

Patients suffering heart failure need examination of the cardiovascular system, the blood and heart function. To improve the quality of life of these patients, control devices must be mobile and autonomous. Direct human condition is usually estimated as following vital parameters: the pulse, blood pressure, respiratory rate, temperature and oxygen saturation. are characteristics of heart and lung function. Pulse frequency can be obtained in several ways: by measuring blood pressure and oxygen saturation. Pulse oximetry was chosen for developing device based on noninvasive spectrophotometric method for measuring oxygen saturation in arterial blood with light and shock pulse.[1-2]

At the Applied Physics department of TPU layout of reflectance pulse oximeter was designed. The device consists of an optical transmitter and the receiving part of the system data acquisition and processing.



Figure 1 - Appearance of the optical sensor

The principle of saturation measurements is measuring reflected light emission signals with two wavelengths of light (red and infrared). This signal will represent the pulse signal because the blood moves within the artery with pulses, increasing the diameter of the artery and thereby increasing absorption. Oxygen saturation is determined by the functional dependence of the signals between the two wavelengths [3-4] .

The ratio between the normalized transmission coefficient for red (r) light $T_{N,r}$ and infrared (ir) light $T_{N,ir}$, varies only as a function of absorbers in the arterial blood (component AC) that is independent from the optical path length. As a result we have

$$R_{OS} = \frac{\ln T_{N,SYS,r}}{\ln T_{N,SYS,ir}} = \frac{A_r}{A_{ir}}$$

for arterial blood, where A_r - absorption of red light;

Air - absorption of infrared light variable component of AC [5-7].

Verification of the device was performed as follows. The device was attached to the forehead of a volunteer using elastic band. Then oxygen saturation was measured during normal breathing and apnea followed within 30s. The measurement results are given in Figure 1: the single breath decreases blood oxygen saturation , which leads to a decrease in the readings .

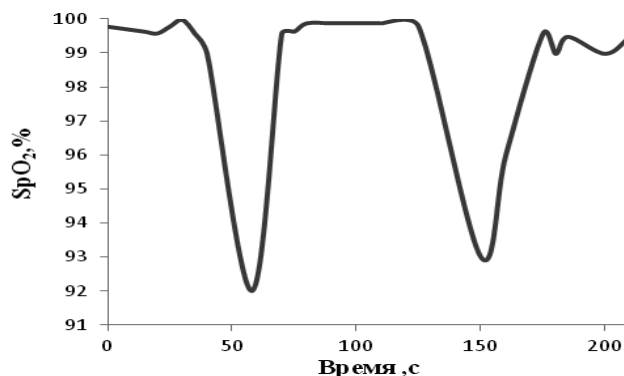

Figure 2 - Typical view of the presence of hypoxia

REFERENCES

1. University of San Diego Char Lie Goldberg. A practical guide to clinical medicine, <http://medicine.ucsd.edu/clinicaimed/vital.htm>.
2. John TB Moyle, Pulse Oximetry. BMJ Books, 2 edition, 2002.
3. J.G.Webster. Design of Pulse Oximeters. Institute of Physics Publishing, 1997.
- 4.Kettler T. Doppler-echokardiographische Messung von Schlagvolumen und Herzzeitvolumen im linksventrikulären Ausflusstrakt und an der Aortenklappe. Med. Diss. Münster. 2008. S. 1.
- 5.Schöller B. Pulsoximetrie-Fibel. Theorie zur Pulsoximetrie. Kalibrierung und Meßstabilität von Pulsoximetern. 2. Auflage. MCC GmbH, Karlsruhe. 2000. S. 13.
- 6.Cooke JE. When Pulse Oximeters Fail: Motion and Low Perfusion. San Francisco. ASA 2000.
- 7.Jurban A. Pluse Oximetry. Tobin MJ (Hrgb). Principles and Practice of Intensive Care Monitoring. Mc Graw-Hill Inc. New York. 1998. S. 269-276.

APPLICATION OF CONFLICTOLOGY METHODS FOR EVALUATING PHYSICAL PROTECTION SYSTEMS EFFECTIVENESS

M.S. Parepko, A.V. Godovykh, B.P. Stepanov

Scientific Supervisor: PhD, Associate Professor B.P. Stepanov

Linguistic Advisor: Senior teacher N.V. Daneikina

Tomsk Polytechnic University, Russia, Tomsk, Lenin str., 30, 634050

E-mail: m sparepko@gmail.com

At present, physical protection of nuclear material and nuclear facilities is actual. For the implementation of physical protection, Physical Protection System (PPS) is created at nuclear facilities. We all know that the most important characteristic is effectiveness of physical protection systems. PPS effectiveness value is determined by the probability that reaction forces can stop and intercept the intruder. There are many methods to assess the effectiveness of PPS. However, not all methods can provide an accurate quantitative assessment of the effectiveness of security systems. This work presents an approach for assessing the resistance of PPS to emerging threat (that is, the intruder to act against items of physical protection). Based on the fact that different processes are subject to universal physical laws and principles of development, a parallel between the concepts of Conflictology field was established to describe the interaction in the system «intruder against PPS».

Keywords: physical protection system, the effectiveness of the physical protection system, intruder, threat, conflict, Conflictology.

Introduction

Currently there are many methods of analysis and safety assessment of the physical object, along with the methods for assessing the effectiveness of physical protection systems. In this paper concepts of Conflictology, which studies the laws of the origin, development, conflict settings, where the conflict means the most acute way of resolving contradictions were used for evaluating the effectiveness of the physical protection. As the object of conflict resolution conflict «man – system» will be used, where a person will act as offender, and under the system we mean a system of physical protection. Based on the availability of explicit confrontation of the offender and the protection system this method of assessment was chosen.

Goal of this paper is introduction to the basic concepts of conflictology and application of acquired knowledge to assess the effectiveness of physical protection systems.

Objectives are:

- estimation of methods and approaches to evaluation of safety in terms of Conflictology;
- using Conflictology methods for assessment actions of intruder and security system;
- analyzing the role of a person in the PPS;
- studying personal and behavioral parameters of the person in terms of Conflictology;
- exploring ways to control and training of these parameters.

Development and methodology

The basis of the approach is the use of the concepts of conflictology. It is a science which deals with the study of the laws of appearance, development and completion of the conflict. In this case, the conflict is a confrontation between the intruder and the physical protection system. Basic concepts of conflictology,

dynamics of the conflict and its major components, such as subject and object were the part of this work. Also it is devoted to the development of conflict in some temporal boundaries. Each of the selected stages of the conflict has individual characteristics, which allowed binding all of the interactions in the "offender against PPS" system to a particular stage of the conflict.

This connection was the basis for creating a mathematical model to estimate the rate of increase of the unauthorized act commission threat at a nuclear facility. In addition, this model allows identifying areas where PPS operates less efficiently and allows acting appropriately to improve it in the future.

In addition to the mathematical model this work deals with the human impact on system performance. In this situation, the increase of the effectiveness of security systems with the influence of human factor is a priority. Currently PPS at nuclear facilities are automated control systems. Central control operator is primarily responsible for their proper functioning. This person (operator) has a certain type of personality and character traits, individual manners of behavior and psychological state. In this case allocation of such basic characteristics as its readiness to work in-house, as well as in emergencies, stressful situations is necessary. It becomes important that employees have the necessary psychological and physiological characteristics that are favorable to effective and efficient work in emergencies. After all, on the reaction rate, the ability to adequately assess the situation and emotional stability of the operator's physical protection system depends on the speed of processing and transmission of alarm response forces. This significantly reduces the time to respond to emerging unauthorized actions on the nuclear facility and allows acting more quickly and effectively in cases of interception so that to neutralize the intruder. These actions eventually determine the effectiveness of PPS as a whole. To resolve identified issues some ways can be suggested to improve and develop the necessary positive qualities through training personnel with different characteristics and trends.

Now we are working on the formation of some effectiveness indicators and indices of physical protection systems. Under the indicators characteristics of the component parts of the physical protection system are understood, and under performance - characteristics of the offender, which includes not only a model offender, equipment and tactics actions, but also his actions in the process of committing unauthorized actions, which can help to successfully overcome the physical protection system and to achieve the goal. This system of criteria (indicators and indices) and their interaction will be the basis for further creation of a software product designed to simulate theft and sabotage at a nuclear facility. Through this modeling, the effectiveness of the physical protection system will be assessed.

Conclusion

The result of this work is a graph, which shows the relationship between risk and offender's actions, which were classified by using the concepts of Conflictology on temporary stages. Thus, the direct link has been established between the actual potential conflict of "man - the system" and the concepts of Conflictology. With this dependence the rate of rise and the threat changes can be estimated thereto from the slope of the theoretical curve; and as a result, we can evaluate the effectiveness of the physical protection system, not only in general, but also at each stage. We can also identify weaknesses and take the necessary measures to improve performance. In addition, the result of this work is a model of conflict analysis, which can be used to analyze the dynamics of theft and sabotage at a nuclear facility. Evaluating method development of PPS effectiveness based

on an assessment of personal and behavioral qualities operator PPS was initiated.

REFERENCES

1. Ancupov A.Ya., Baklanovskij S.V. Konfliktologiya v sxemax i kommentariyax: Uchebnoe posobie, Conflictology in diagrams and comments: Textbook (Konfliktologiya, St. Petersburg, 2009), p.304.
2. Emelyanov S.M. Praktikum po konfliktologii: Uchebnoe posobie, Conflictology workshop: Textbook (Konfliktologiya, St. Petersburg, 2001).
3. Semenov V.A. Konfliktologiya: istoriya, teoriya, metodologiya: Uchebnoe posobie, Conflictology: history, theory, methodology: Textbook (Konfliktologiya, St. Petersburg., 2008).
4. Schwartz G. Conflict management: diagnosis, analysis and resolution of conflicts (St. Petersburg., 2007), p.296.
5. Materials of lecture «IAEA REGIONAL TRAINING COURSE Physical Protection of Nuclear Research Reactor».
6. Materials of lecture «Mitigation the Insider Threat Using Behavioral Science».

PARAMETERIZATION OF THE TURBULENT DIFFUSION COEFFICIENT OF INDUSTRIAL EMISSIONS

E.A. Pokrovskaya, V.O. Babicheva

Scientific Supervisor: PhD Associate Professor N.K. Ryzhakova

Linguistic Advisor: Senior teacher N.V. Demjanenko

Tomsk Polytechnic University, 634050, Tomsk, Russia, Lenin Avenue, 30

E-mail: nkryzh@tpu.ru

Annotation

*Turbulent diffusion of industrial emissions is one of the main transport mechanisms that determine the spatial distribution of pollutants in the atmospheric boundary layer. One of the famous ways to study the basic laws of the spatial distribution of the contaminant is a mathematical modeling of the transport of particles in the air. A diffusive-convective transport model had got wide recognition. A parameter of the diffusive-convective transport model is a vertical eddy diffusion coefficient k_z . In the simulation of vertical transport impurities the parameterization of turbulent diffusion coefficient is often used in the form: $k_z = k_{pr} * z$. A parameter k_{pr} essentially depends on roughness and temperature heterogeneity of the underlying surface, convective flow and disperse composition impurities. Due to the complexity of the turbulence diffusion processes, adequate description of the vertical transporting is not possible without the involvement of the models, based on experimental materials. In this paper we propose the parameter describing the turbulent diffusion of industrial emissions determinate like solving an inverse problem on the distribution of the contaminant measured along a certain direction from a point source. The content of harmful substances in the air is relatively small, especially at a considerable distance from the source. Therefore, to measure the distribution of the contaminant it is advisable to use the method of moss-biomonitoring, exposure time of which is determined by the length growth of moss and it is a year or more. The method is widely used to study air pollution by heavy metals (HM) [1-4].*

Modeling of spatial distribution of contaminant concentrations in the surface layer of the atmosphere

Modeling of the spatial distribution of HM, containing in industrial emissions, is based on the diffusion-convection transport equation, which has the form [5]:

$$u \frac{\partial q}{\partial x} + V_g \frac{\partial q}{\partial z} = \frac{\partial}{\partial z} k_z \frac{\partial q}{\partial z},$$

for the average values of impurity concentrations q excluding turbulent diffusion in the horizontal plane of the surface atmosphere. Where u - wind speed in the x -direction; V_g - gravitational settling velocity of impurity particles.

An analytical solution of this equation as a power approximation of the wind speed and the vertical turbulent diffusion coefficient for a point source, taking into account background concentrations q_f , is taken the following form [5,6]:

$$q(x) = \theta_1 x^{\theta_2} \exp\left(-\frac{\theta_3}{x}\right) + q_f$$

In accordance with previous work [5] the distribution parameter θ_3 can be written as follows:

$$\theta_3 = \frac{u_1 H^{1+n}}{(1+n)^2 k_{np}}$$

where n - is a parameter characterizing the change in wind speed with height, H - is a height of the pollution source pipe; u_1 - is a wind speed at a height of 1 m.

Numerical value of θ_3 parameter can be found using the method of least squares (MLS) by function of the form (2) for the approximation of the measured distribution. Then the expression (3) can be used to determine k_{pr} by substituting wind speed value averaged in the selected direction during the exposure time.

Experiment

The study used a three-year growth of epiphytic moss *Pylaisia polyantha* (Hedw.) BSG, which were taken in the area of influence of CHP-5 in Novosibirsk (Russia). Sampling was carried out in a northeasterly direction from the CHP-5 from the bark of birch and poplar trees at a height of 1.5-2 meters from the ground at distances from one to five kilometers. Background samples were taken on a site remote from the main population centers and businesses over a distance of 200 km. Background samples were taken on a site remote from the main population centers and businesses over a distance of 200 km.

Determination of chemical elements in the moss samples was produced by neutron activation method at the research reactor IRT-T of National Research Tomsk Polytechnic University (Russia). In the study, 38 samples of moss were prepared and measured, which determined the content of the following elements: Ba, Hf, Eu, Fe, Yb, Co, La, Lu, As, Nd, Rb, Sm, Sc, Sr, Sb, Cr, Cs, Ce, Zn; sample preparation was performed according to procedure [4]. As an example, Pic.1 shows the concentration distribution of Co and Sr given the level of background, the solid line shows the results of the approximation of the measured values by the function (2) by MLS.

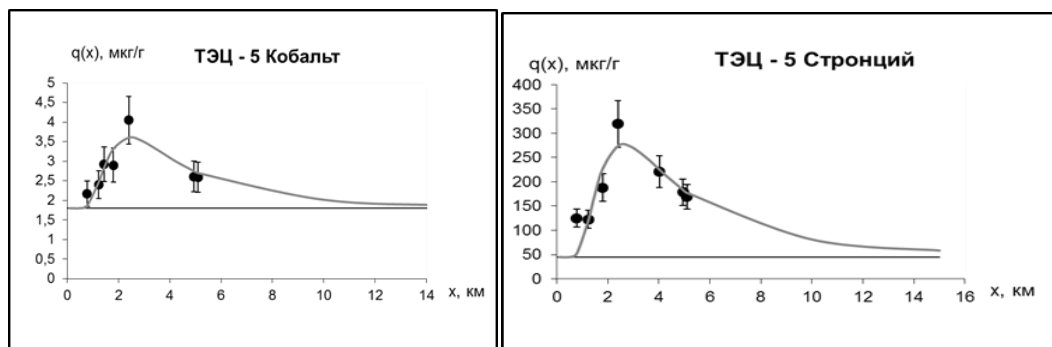

Pic.1 Distribution of Co and Sr concentrations depending on the distance: solid curve – is the result of the approximation function (2), the horizontal line – is background concentrations.

Table 1 shows k_{pr} and vertical eddy diffusivity k_z on different heights with $n = 0,2$ and the average wind speed $u_1 = 3,7$ m / s, the values of the parameter θ_3 , defined by OLS.

Table 1 The value of parameters θ_3 , k_{pr} and vertical diffusion coefficient k_z at different heights ($n = 0,2$; $u_1 = 3,7$ m / sec.)

Element	θ_3	$k_{пр}$, m/s	$k_{з\phi}$, m^2/s			
			z=100 m	z=150 m	z=200 m	z=250 m
Ba	8	0,08	7,6	11,5	15,3	19,1
Hf	6	0,1	10,4	15,6	20,8	26
Eu	5	0,12	12,3	18,4	24,5	30,6
Fe	10	0,06	5,9	8,8	11,8	14,7
Yb	8	0,08	7,6	11,5	15,3	19,1
Co	8	0,08	7,6	11,5	15,3	19,1
La	8	0,08	7,6	11,5	15,3	19,1
Lu	8	0,08	7,6	11,5	15,3	19,1
As	8	0,08	7,6	11,5	15,3	19,1
Nd	8	0,08	7,7	11,5	15,3	19,1
Rb	7	0,09	9,3	14	18,6	23,3
Sm	8	0,08	7,7	11,5	15,3	19,1
Sc	9	0,07	6,6	9,9	13,3	16,6
Sr	8	0,08	7,7	11,5	15,3	19,1
Sb	8	0,08	7,7	11,5	15,3	19,1
Cr	8	0,08	7,7	11,5	15,3	19,1
Cs	8	0,08	7,7	11,5	15,3	19,1
Ce	7	0,09	9,4	14,1	18,8	23,6
Zn	8	0,08	7,7	11,5	15,3	19,1

The values of K_{pr} parameter are in the range of 0.07 ... 0.12 m / s, the average value at significance level of 0.05 and confidence interval $\pm 0,003$ m / s for this sample is $k_{pr} = 0.082$ m / s. It was found by the distributions of 19 chemical elements. The k_{pr} parameter is the result of averaging over all states of the atmosphere at a particular location during the exposure time (in our case over 3 years). According to [5] for the convective transport model k_{pr} is in the range 0.1 ... 0.2 m / s, and at a temperature inversion the k_{pr} coefficient is significantly lower. Comparison of these data with the results obtained in the study shows that in the area adjacent to the CHP-5 Novosibirsk, a convective conditions of transfer are more likely.

Found via moss biomonitoring values of vertical turbulent diffusion coefficient can be used during the annual estimates of levels of contamination of the surface layer of the atmosphere by HM. Also it can be used to predict the spatial distribution of the contaminant in the atmospheric boundary layer for the sources of pollution that located on the study area. Modeling the spatial distribution of the contaminant using the parameter values k_{pr} also allows determining the zone of influence of factories and deposition of HM region.

References

1. Harmens H., David N. and participants of the moss survey. (2008): Spatial and Temporal Trends in Heavy Metal Accumulation in Europe (1990-2005). Bangor. Wales. Programme Coordination Centre for the ICP

Vegetation. Centre for Ecology and Hydrology Centre for Ecology and Hydrology.

2. Coskun M., Cayir A., Coskun M., Kilic O. (2011): Heavy metal deposition in moss samples from east and south Marmara region, Turkey. *Environmental Monitoring and Assessment*, 174 (1-4): 219-227.
3. Shotbolt L., Bükер P., Ashmore M. (2007): Reconstructing temporal trends in heavy metal deposition: Assessing the value of herbarium moss samples. *Environmental Pollution*, 147 (1-3): 120-130.
4. Рыжакова Н. К., Борисенко А. Л., Меркулов В. Г., Рогова Н. С. Контроль состояния атмосферы с помощью мхов-биоиндикаторов // *Оптика атмос-феры и океана*, 2009 – т. 22, – №1. с. 101 – 104.
5. Берлянд М.Е. Прогноз и регулирование загрязнения атмосферы. – Л.: Гидрометеиздат, 1985. - 272 с.
6. Гусев Н. Г., Беляев В. А. Радиоактивные выбросы в биосфере: справочник - 2-е изд., перераб. и доп. - М.: Энергоатомиздат, 1991. - 256 с.
7. Н.К. Рыжакова, В.Ф. Рапуга, Н.С. Рогова, А.Л. Борисенко, Е.А. Покровская. Пространственное распределение химических элементов атмосферных выбросов угольной ТЭЦ// *Экология и промышленность России*.- 2013-№. 1. – С. 52-55.

NONLOCAL ONE-DIMENSIONAL FISHER–KOLMOGOROV–PETROVSKII–PISKUNOV EQUATION WITH ABNORMAL DIFFUSION

A.A. Prozorov, A.D. Isakov

Scientific Supervisor: Dr., Prof. A.Yu. Trifonov

Linguistic Advisor: O.P. Kabrysheva

Tomsk Polytechnic University, Russia, Tomsk, Lenin str., 30, 634050

E-mail: prozorov_a_a@mail.ru

Abstract. Analytical solutions are constructed for the nonlocal space fractional Fisher–Kolmogorov–Petrovskii–Piskunov equation with abnormal diffusion. Such solutions allow us to describe quasi-steady state patterns. Special attention is given to the role of fractional derivative. Fractional diffusion equations are useful for applications in which a cloud of particles spreads faster than predicted by the classical equation. The resulting solutions spread faster than the classical solutions and may exhibit asymmetry, depending on the fractional derivative used. Results of numerical simulations and properties of analytical solutions are presented. Influence of the fractional derivative on patterns ordered in space and time is discussed.

Keywords: Fractional reaction–diffusion, pattern formation, nonlocal population dynamics, Fisher–Kolmogorov–Petrovskii–Piskunov equation, semiclassical approximation.

INTRODUCTION

Reaction–diffusion equations are useful in many areas of science and engineering [1]. In applications to population biology, the reaction term models growth, and the diffusion term accounts for migration. The classical diffusion term originates from a model in physics. Recent research indicates that the classical diffusion equation is inadequate to model many real situations, where a particle plume spreads faster than that predicted by the classical model, and may exhibit significant asymmetry. These situations are called anomalous diffusion [2]. One popular model for anomalous diffusion is the fractional diffusion equation, where the usual second derivative in space is replaced by a fractional derivative of order $0 < \alpha < 2$. Solutions to the fractional diffusion equation spread at a faster rate than the classical diffusion equation, and may exhibit asymmetry. However, the fundamental solutions of these equations still exhibit useful scaling properties that make them attractive for applications.

Nonlocal reaction-diffusion (RD) models are generally used to describe structures ordered in space and time. Structures of this type, formed by self-organization mechanisms, are involved in many important phenomena in biology, medicine, epidemiology, and ecology, such as the pattern formation in population dynamics, cancer treatment, evolution of infectious diseases, etc. (see, e.g., the review papers [3, 4], and references therein). The evolution of one-species microbial populations with long-range interactions between individuals is modeled by a nonlocal generalization of the classical Fisher–Kolmogorov–Petrovskii–Piskunov (FKPP) equation [3, 4] for population density $u(x, t)$:

$$u_t(x, t) = D\Delta u(x, t) + au(x, t) - bu^2(x, t). \quad (1)$$

Equation (1) contains terms that describe a diffusion process with coefficient D , population growth with rate a , and the local competition between individuals with rate b .

Nonlocal effects arise in competitive interactions of microbial populations due to the diffusion of nutrients,

the release of toxic substances, chemo taxis, and molecular interactions between individuals.

In generalized FKPP equation local quadratic losses $bu^2(x,t)$ are replaced by an integral expression $u(x,t)\int b_\gamma(x,y)u(y,t)dy$, which takes into account nonlocal interactions in the population through the influence function $b_\gamma(x,y)$. Parameter γ describes the effective area of interaction between individuals in population. So, when $\gamma \rightarrow 0$ it's fair $b_\gamma(x,y) \rightarrow b\delta(x-y)$, and nonlocal losses go to local $bu^2(x,t)$ FKPP equation considering nonlocal quadratic losses in the interval $[-l,l]$ will be

$$u_t(x,t) = Du_{xx}(x,t) + au(x,t) - \chi u(x,t) \int_{-l}^l b_\gamma(x,y)u(y,t)dy. \quad (2)$$

Spatio- time structures (patterns) are not formed in the course of evolution , described by the classical FKPP equation (1). Nonlocal FKPP equation allows to describe the formation of structures that arise due to the loss of competitive and non-local diffusion with an appropriate choice of parameters of the equation.

Note that the main method of examination of structure formation in above works is numerical simulation . The paper is focused on the analytical method. One-dimensional model is chosen for mathematical simplicity .

DEFINITION OF FRACTIONAL DERIVATIVES

There are several different approaches to the definition of fractional order derivative, reflecting the peculiarities of fractional calculus. The most widely and frequently used definition is made by Riemann-Liouville, based on the generalization of the Abel equation [5]

$$D_-^\alpha f(x) = \frac{1}{\Gamma(n-\alpha)} \frac{d^n}{dx^n} \int_{-\infty}^x \frac{f(t)dt}{(x-t)^{\alpha+1-n}}, \quad (n-1 < \text{Re}(\alpha) \leq n, n \in N)$$

Here the standard notation is used for the differentiation operator and Γ -functions.

Simplification of this definition is the definition made by Caputo, which is applicable for sufficiently smooth functions where the operation of differentiation may be included under the integral sign:

$$D_-^\alpha f(x) = \frac{1}{\Gamma(n-\alpha)} \int_{-\infty}^x \frac{f^{(n)}(t)dt}{(x-t)^{\alpha+1-n}}, \quad (n-1 < \text{Re}(\alpha) \leq n, n \in N)$$

A.Grunvald and independently Letnikov introduced the concept of fractional derivative as the limit of difference relations:

$$f^{(\alpha)}(x) = \lim_{h \rightarrow 0} \frac{1}{h^\alpha} \sum_{k=0}^{\infty} (-1)^k C_n^k f(x + (n-k)h)$$

If $f(x)$ is continuous and $df(x)/dx$ is integrable in the interval $[a,x]$, then the derivatives of the Riemann-Liouville and Caputo and Grunvald-Letnikov exist and coincide.

ONE-DIMENSIONAL NONLOCAL FKPP EQUATION

Let's consider the equation (2) with a difference kernel $b_\gamma(x,y) = b_\gamma(x-y)$, $b_\gamma(x)$ is assumed to be even:

$$u_t(x,t) = Du_\alpha(x,t) + au(x,t) - \chi u(x,t) \int_{-l}^l b_\gamma(x-y)u(y,t)dy, \quad (3)$$

where α – is an order of fractional derivative. The functions $b_\gamma(x)$ and $u(x,t)$ are expanded in a Fourier series:

$$b_\gamma(x-y) = \sum_{m=-\infty}^{\infty} b_m e^{i\pi m(x-y)/l}, \quad b_m = \frac{1}{2l} \int_{-l}^l b(\tau) e^{-i\pi m\tau/l} d\tau.$$

$$u(x,t) = \sum_{k=-\infty}^{\infty} \beta_k(t) e^{i\pi kx/l}, \quad \beta_k(t) = \frac{1}{2l} \int_{-l}^l u(z,t) e^{-i\pi kz/l} dz. \quad (4)$$

Then (4) $u_\alpha(x,t)$, according to [5], will be defined as

$$u_\alpha(x,t) = \sum_{k=-\infty}^{\infty} \left(\frac{ik\pi}{l} \right)^\alpha \beta_k(t) e^{i\pi kx/l}, \quad i^\alpha = e^{i\pi\alpha/2}.$$

The derivative of the exponent is e^{ax} with order $0 < \alpha < 1$ by definition of fractional derivative of Caputo

$$D_-^\alpha e^{ax} = \frac{1}{\Gamma(1-\alpha)} \int_{-\infty}^x \frac{e^{at} dt}{(x-t)^\alpha} = \left| x-t = \tau \right| = \frac{e^{ax}}{\Gamma(1-\alpha)} \int_0^\infty \frac{e^{-a\tau} dt}{\tau^\alpha} =$$

$$= \left| a\tau = t \right| = \frac{a^\alpha e^{ax}}{\Gamma(1-\alpha)} \int_0^\infty e^{-t} t^{(1-\alpha)-1} dt = a^\alpha e^{ax}$$

And by definition of Grynvald-Letnikov

$$(e^{ax})^{(\alpha)} = \lim_{h \rightarrow 0} \frac{1}{h^\alpha} \sum_{k=0}^{\infty} (-1)^k C_\alpha^k e^{ax+a(\alpha-k)h} =$$

$$= e^{ax} \lim_{h \rightarrow 0} \frac{1}{h^\alpha} \sum_{k=0}^{\infty} (-1)^k C_\alpha^k e^{ah(\alpha-k)} = e^{ax} \lim_{h \rightarrow 0} \frac{1}{h^\alpha} (e^{ah} - 1)^\alpha = a^\alpha e^{ax}$$

The differentiation with respect to time ratio (4), expressing the function $u_\alpha(x,t)$ presented in (3), shows:

$$\dot{\beta}_k(t) = \frac{1}{2l} \int_{-l}^l e^{-i\pi kz} u_t(z,t) dz = \frac{1}{2l} \int_{-l}^l dz \left(Du_\alpha(z,t) + au(z,t) - \chi u \sum_{n=-\infty}^{\infty} b_n e^{\frac{i\pi n z}{l}} \beta_n(t) \right) e^{-i\pi kz} =$$

$$= \frac{1}{2l} \sum_{j=-\infty}^{\infty} \beta_j(t) \int_{-l}^l dz \left(D \left(\frac{ij\pi}{l} \right)^\alpha + a - \chi \sum_{n=-\infty}^{\infty} b_n e^{\frac{i\pi n z}{l}} \beta_n(t) \right) e^{\frac{i\pi z(j-k)}{l}} =$$

$$= \sum_{j=-\infty}^{\infty} \beta_j(t) \left[\frac{1}{2l} \left(D \left(\frac{ij\pi}{l} \right)^\alpha + a \right) \int_{-l}^l e^{\frac{i\pi z(j-k)}{l}} dz - \frac{\chi}{2l} \sum_{n=-\infty}^{\infty} \beta_n(t) b_n \int_{-l}^l e^{\frac{i\pi z(n-(k-j))}{l}} dz \right] =$$

$$= \sum_{j=-\infty}^{\infty} \beta_j(t) \left[\left(D \left(\frac{ij\pi}{l} \right)^\alpha + a \right) \delta_{j,k} - \chi \sum_{n=-\infty}^{\infty} \beta_n(t) b_n \delta_{n,k-j} \right].$$

$$\dot{\beta}_k = \beta_k \left(D \left(\frac{ik\pi}{l} \right)^\alpha + a \right) - \chi \sum_{j=-\infty}^{\infty} \beta_{k-j} b_{k-j} \beta_j, \quad k = \overline{-\infty, \infty}. \quad (5)$$

We will seek the coefficients β_j in the form $\beta_j(t) = \beta_0(t) \delta_{j0}$.

$$\dot{\beta}_0(t) = \beta_0(t) a - \chi \beta_0^2(t) b_0. \quad (6)$$

Equation (6), with the initial conditions $\beta_j|_{t=0} = \beta_{00} \delta_{j0}$, is

$$\beta_0(t) = \frac{\beta_{00} e^{at}}{1 + \frac{\chi b_0 \beta_{00}}{a} (e^{at} - 1)}. \quad (7)$$

Now let's look for solutions of the equation (5) β_j in the form

$$\beta_j(\theta, \tau, T) = \beta_j^{(0)}(\theta, \tau) + \frac{1}{T} \beta_j^{(1)}(\theta, \tau) + \dots, \quad \theta = \phi(\tau)T, \quad (8)$$

where $\beta_j^{(0)}$ is defined by (7). Expansion (8) with (4) induces expansion

$$u(x, t) = u^{(0)}(x, t) + \frac{1}{T} u^{(1)}(x, t), \quad (9)$$

Taking into the account the rules of differentiation of composite functions we get

$$\frac{d}{dt} = \frac{\partial \theta}{\partial t} \frac{\partial}{\partial \theta} + \frac{\partial \tau}{\partial t} \frac{\partial}{\partial \tau} = \varphi_\tau \frac{\partial}{\partial \theta} + \frac{1}{T} \frac{\partial}{\partial \tau}.$$

As a result, the system (5) takes the form

$$\left[\varphi_\tau \frac{\partial}{\partial \theta} + \frac{1}{T} \frac{\partial}{\partial \tau} \right] \left(\beta_j^{(0)} + \frac{1}{T} \beta_j^{(1)} + \dots \right) = \bar{a}_j \left(\beta_j^{(0)} + \frac{1}{T} \beta_j^{(1)} + \dots \right) - \chi \sum_{p=-\infty}^{\infty} b_p \left(\beta_{j-p}^{(0)} + \frac{1}{T} \beta_{j-p}^{(1)} + \dots \right) \left(\beta_p^{(0)} + \frac{1}{T} \beta_p^{(1)} + \dots \right),$$

where

$$\bar{a}_j = \left(D \left(\frac{ij\pi}{l} \right)^\alpha + a \right).$$

Equating terms of the same power $1/T$, we obtain

$$\varphi_\tau \frac{\partial}{\partial \theta} \beta_j^{(0)} = \bar{a}_j \beta_j^{(0)} - \chi \sum_{p=-\infty}^{\infty} b_p \beta_{j-p}^{(0)} \beta_p^{(0)}, \quad \text{и} \quad \varphi_\tau \frac{\partial}{\partial \theta} \beta_j^{(1)} = \bar{a}_j \beta_j^{(1)} - \chi \sum_{p=-\infty}^{\infty} b_p (\beta_{j-p}^{(1)} \beta_p^{(0)} + \beta_{j-p}^{(0)} \beta_p^{(1)}) - \frac{\partial}{\partial \tau} \beta_j^{(0)}, \dots \quad (10)$$

Let's $\varphi(\tau) = a\tau$. Then from (10) it follows that

$$\frac{\partial}{\partial \theta} \beta_0^{(1)} = \beta_0^{(1)} - \frac{2\chi b_0}{a} \beta_0^{(0)} \beta_0^{(1)}, \quad \frac{\partial}{\partial \theta} \beta_j^{(1)} = \frac{\bar{a}_j}{a} \beta_j^{(1)} - \frac{\chi}{a} \beta_0^{(0)} (b_0 \beta_j^{(1)} + b_j \beta_j^{(1)}). \quad (11)$$

Solving the system (10) and (11), considering that $\frac{\partial}{\partial \tau} \beta_j^{(0)} = 0$, we will find the coefficients $\beta_j^{(0)}$ and $\beta_j^{(1)}$. For the case of symmetric initial distribution up to $O(1/T^2)$ we obtain

$$u(x, t) = \frac{\beta_{00} e^{at}}{1 + \frac{\chi b_0 \beta_{00}}{a} (e^{at} - 1)} + \frac{1}{T} \sum_{j=-\infty}^{\infty} \frac{\beta_{1j} e^{\bar{a}_j t} e^{ij\pi x/l}}{\left[1 + \frac{\chi \lambda_0 \beta_{00}}{a} (e^{at} - 1) \right]^{(b_j + b_0)/b_0}}.$$

$$\text{Im} \left(u^{(1)}(x, t) \right) = \sum_{j=-\infty}^{\infty} \frac{e^{(D | \frac{j\pi}{l} |^\alpha \cos(\frac{\pi}{2} \alpha) + a)t} \sin \left[D \left| \frac{j\pi}{l} \right|^\alpha \sin \left(\frac{\pi}{2} \alpha \text{sgn} j \right) t + \frac{j\pi x}{l} \right]}{\left(1 + \frac{\chi \lambda_0 \beta_{00}}{a} (e^{at} - 1) \right)^{(b_j + b_0)/b_0}}.$$

You may notice that $\text{Im}(u^{(1)}(x, t)) = 0$. Let's choose $b_j = b_0 \exp\{-(x-y)^2/\gamma^2\}$.

Now let's consider how the population density depends on the degree of diffusion.

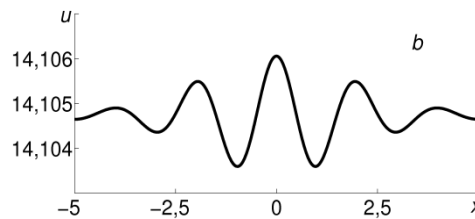
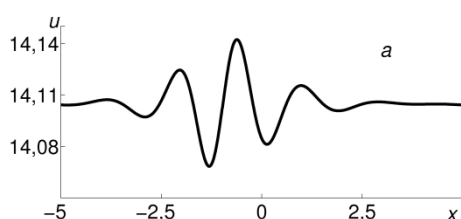

Fig. 1. Graph of function $u(x,t)$ for $t = 50$ and $\alpha = 1.5$ (a), 2 (b), $a = 0.5$, $b_0 = \gamma = 1$, $\chi = 0.2$, $D = 0.01$, $l = 5$, $T = 10$

The first and second moments $u(x,t)$ for $\alpha = 1.5$, respectively calculated by the formulas (fig. 2):

$$M(t) = \int_{-l}^l xu(x,t)dx, \quad D(t) = \int_{-l}^l (x - M(t))^2 u(x,t)dx.$$

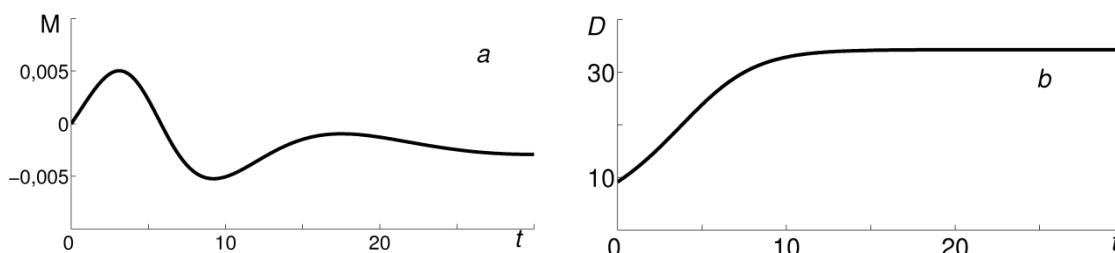

Fig. 2. Graph of the first initial moment $M(t)$ (a) and second central moment $D(t)$ (b).

As can be seen from the graphs (fig. 1), the lower the order of the fractional derivative, the greater the displacement of the center and stronger the deviation from the steady state.

CONCLUSION

The phenomenon of pattern formation in one-species populations was studied using a number of models based on generalized Fisher–Kolmogorov–Petrovskii–Piskunov (FKPP) equations taking into account nonlocal interaction effects. The paper has been focused on a special type of pattern formation with abnormal diffusion. The lower the order of the fractional derivative, the greater the displacement of the center and stronger the deviation from the steady state.

This solution is spatially homogeneous and monotonically depending on time. By analogy with previous studies, it was assumed that the patterns above can be described as large time perturbations of this exact solution. The large time asymptotics are constructed explicitly, to within $O(1/T^2)$, in the class of functions which tend to the above exact solution as $T \rightarrow \infty$. Thereby, the exact solution can be regarded as an attractor of the constructed class of asymptotic solutions and, hence, of the corresponding concentrated patterns. As the patterns evolve monotonically without qualitative changes to some steady-state, it's concluded asymptotic solutions describe approximately the quasi-steady-state patterns. The contribution of diffusion to the pattern formation has been investigated.

The approach used allows one, on the one hand, to gain information on the most essential characteristics of patterns and, on the other hand, to apply the methods developed for 1D problems to multidimensional problems.

The formalism proposed can be generalized to concentration manifolds of more general topological structure, such as multiply connected manifolds, and to curved manifolds describing the growth of microbial populations on complex structure objects.

The work is supported by the Russian Foundation of Science.

REFERENCES

1. N.F. Britton. Reaction–Diffusion Equations and Their Applications to Biology. Academic Press Inc. [Harcourt Brace Jovanovich Publishers], London (1986)
2. R. Metzler, J. Klafter. The random walk’s guide to anomalous diffusion: A fractional dynamics approach. Phys. Rep., 339 (2000)
3. Samko, S.; Kilbas, A.A.; and Marichev Fractional Integrals and Derivatives: Theory and Applications, Gordon and Breach Science, 1993.
4. Fisher R. A. The wave of advance of advantageous genes // Annual Eugenics. V. 7. P. 255 (1937)
5. A. N. Kolmogorov, I. G. Petrovskii and N. S. Piskunov, A study of the diffusion equation with increase in the quantity of matter, and its application to a biological problem, Bull. Moscow Univ. Math. ser. A1, 1-25 (1937).
6. Fuentes M.A., Kuperman M.N., Kenkre V.M. Nonlocal interaction effects on pattern formation in population dynamics // Phys. Rev. Lett. 2003. V. 91. P. 158104.
7. Murray J.D. Mathematical Biology. I. An Introduction. Third edition. N. Y., Berlin, Heidelberg: Springer-Verlag, 2001.
8. Levchenko E. A., Shapovalov A. V., Trifonov A. Yu. Pattern formation in terms of semiclassically limited distribution on lower dimensional manifolds for the nonlocal Fisher–Kolmogorov–Petrovskii–Piskunov equation. J. Phys. A: Math. Theor. 47 (2014) 000000 (20pp), TB, MD, US, JPhysA/478013, 2/12/2013

SOLAR ENERGY

M.P. Pustovalova

Scientific Supervisor: S.N. Chegrincev,

Linguistic Advisor: PhD, Associate professor T.G.Petrashova

Tomsk Polytechnic University, Russia, Tomsk, Lenin str., 30, 634050

E-mail: pustovalova_madina@mail.ru

Annotation

This article is about the development of renewable sources in the form of solar energy. It features comprehensive discussions of many aspects of solar energy development in Russia and around the world. The purpose this article is to tell about advantages of solar energy.

Key words: Solar radiation, crystalline silicon, renewable, Rusnano, development, Ben Peters, power stations, potential.

Solar energy is energy derived from the Sun's radiation. The Sun is an powerful source of energy and provides the Earth with as much energy every hour as we collectively use in a year worldwide. It is important that we continue to harness and increase our use of solar energy (and other clean, renewable energies) as fossil fuels become depleted, expensive, and fall out of favor with their consumers [1].

As the global demand for energy grows and conventional energy resources become increasingly costly to extract, people are looking to the power of the Sun. Solar has been growing exponentially for the last 20 years, while the price of photovoltaic (PV) cells has dropped 20% whenever manufacturing capacity doubles; PV cell prices are 99% lower now than they were in 1976. It is no longer the cost-prohibitive energy source it once was [2].

Solar power is important because every beam of light that we can convert into electricity is another step in reducing our dependence on polluting fossil fuels. Each year more and more people are investing in their own energy portfolios by installing solar panels on their homes, but not everyone has that option (e.g. due to home ownership, geographic location, home orientation, etc.). The «Mosaic» company allows people to become investors in solar projects to earn competitive returns while also helping out the environment. When one thinks of solar power, PV or solar panels come to mind. Even within the category of PV there are many applications and variants of the technology, but fundamentally, PV enables us to directly convert sunlight into electricity. Semiconductor materials (like those used in computers) make up solar cells and are used to convert photons (e.g. light) to electricity. PV arrays consist of solar cells which can come in a variety of shapes and sizes. The PV array on a house generating electricity is likely made of traditional crystalline silicon. Alternatively, thin film solar utilizes stacked semiconductors only a few micrometers thick that can be applied as roof shingles or solar window tinting to generate electricity. What thin film gains in versatility and price reductions, it loses in terms of conversion efficiency. Typical solar cells have an efficiency of around 15%, although there are models that are up to 21% efficient [3].

The experience of many countries shows that under certain climatic, economic and political conditions, solar energy today can become a real competitor to traditional energy. In many countries, solar energy received strong government support and rapidly evolving. In Europe, Germany has a leading position on the established solar

station, but China has become a leader in the use of solar radiation for the past year. Last year, Saudi Arabia's plans to launch a massive renewable energy program was the big news coming out of the Middle East – but internal wranglings have resulted in uncertainty about the future of the project. Australia is one of the sunniest countries in the world and there is huge potential for solar PV to make a significant contribution to electricity generation. Japan, Germany, and the United States are major markets for solar cells [4].

Roughly, 10 companies in Russia are involved in production of solar collectors that are used to produce heat. The Ministry of Fuel and Energy estimated the total area of all solar collectors in 1994 at 100,000 m². In most cases, these installations work in the south of the country and only during the warm seasons of the year. Beside the commercial solar collectors, it is a common practice in the countryside of Russia to use showers that use water heated by the sun. Even the use of these primitive devices throughout the country eliminates the need to burn millions of tons of coal, oil, and gas to heat water. The use of solar power, though still in its infancy, is starting to shine through as a promising alternative energy source in Russia's regions.

Russia may be associated more with long, dark winters than sun-drenched days, but that does not stop private companies from tapping into a growing market for solar energy. Solar Wind produces panels mostly for export hopes to see the domestic market grow. A number of Russian private companies are creating joint ventures with Rusnano, the state nanotechnology corporation, to address local needs. Solar Wind is starting a \$160m project, with Rusnano as a partner, in which it will make double-sided solar panels for domestic use. The plant, which may start working at the end of this year or in the first quarter of 2011, will have an initial annual manufacturing capacity of 30 megawatts (MW), ramping up to 120 MW per year. Private firms and regional governments are his customers locally, and the company exports solar panels to more than 22 countries, including Germany, Britain and the United States. Industry insiders said solar energy could become a real alternative to traditional energy sources in a number of the country's regions. The Krasnodar Region and most parts of Siberia have insolation levels comparable to the south of France and central Italy, where solar energy is currently booming, while the Zabaikalsky Region gets more solar energy than Spain head of the environment monitoring department at the Electricity and Energy Council of the Commonwealth of Independent States [5].

The Krasnodar Region turned its attention to solar energy after it launched an energy-efficiency programme in 2006. The region uses solar power for electricity production and heating water. The roof of the central hospital in Ust-Labinsk, a town northeast of Krasnodar, is being covered by 300 solar panels. The installation will heat water for the hospital's daily needs all year-round.

Solar energy use has a future in Russia, but only in combination with other renewable energy sources a board member of Eurosolar Deutschland, the German division of the European Association for Renewable Energy. Solar energy is not yet popular in Russia because of the country's focus on oil exports. Another obstacle is the cost of solar power-station construction, compared with traditional power stations. The construction cost of a solar power station ranges from \$10,000 to \$17,000 per kilowatt. In comparison, one kilowatt of installed capacity at a nuclear power station costs up to \$3,000, while the figure for a hydroelectric power station is \$1,000. That makes building solar power stations less effective for Russia's economy than construction of traditional power stations adding that hydroelectric and biofuel energy generation are the best options.

One of the biggest question marks facing the future of the solar industry is the ability to provide cost effective storage. Solar energy's nature is a fact that many say could prevent more widespread adoption of the technology as a viable replacement for traditional energy generation. Ben Peters, director of solar finance and policy at REC Solar, predicts improved technologies – bolstered by involvement from large-name corporations – will pave the way for more affordable solar storage. Ben Peters explained «I see more and more of the large tech conglomerates getting into solar plus energy storage,». Ben Peters statement that «You have a large number of big names like Bosch, GE and Panasonic that recognize the economic value of solar storage to customers. We're really starting to see it take off from an actual innovation standpoint.» Solar Energy - one of the most promising directions of development of renewable energy sources . According to experts, by 2100, the sun will be the dominant source of energy on the planet [6].

Thus, thanks to modern equipment solar energy helps to solve the needs of cities - from savings on electricity production to environmental protection. Global consciousness of humanity is changing. In the new millennium, it finally recognized the need to transition to new energy sources. More and more countries are interested in the promotion and development of technologies for the production of solar energy, more is created and improved photovoltaic modules, inverters, power increases for energy conversion.

REFERENCES

1. Greenough River Solar Farm (2014). What is solar energy?Home page. Retrieved 2014, from <http://www.greenoughsolarfarm.com.au/solar-energy/what-solar-energy>
2. Mosaic (2010). What is solar energy? Magazine. Retrieved 2010, from <https://joinmosaic.com/what-is-solar-energy>
3. Vince Font (2014 February). The Solar Energy Outlook for 2014. Magazine. Retrieved 2014, February 14 from <http://www.renewableenergyworld.com/rea/news/article/2014/02/the-solar-energy-outlook-for-2014>
4. National Geographic (1996). Solar Energy. Magazine.Retrieved 1996 from <http://environment.nationalgeographic.com/environment/global-warming/solar-power-profile/>
5. INFORSE-EUROPE (2000 January). Solar Energy. Forum.Retrieved 2014, February 10 from http://www.inforse.org/europe/success/SU_S_RU.htm
6. Filatova I. (2010 December). The use of solar power, though still in its infancy, is starting to shine through as a promising alternative energy source in Russia's regions. The newspaper – Moscow News. Retrieved 2010, December 3 from <http://www.telegraph.co.uk/sponsored/rbth/business/8179143/Solar-power-development-takes-root-in-Russia-across-regional-sun-traps.html>

CALCULATION OF ENERGY RELEASE FUNCTION OF FOCUSED ION BEAM IN SOLIDS

X.S. Ryabkina

Scientific Supervisor: Ph.D. O.M. Stepanova

Linguistic advisor: Senior teacher N.V. Demjanenko

National Research Tomsk Polytechnic University, Russia, Tomsk, Lenin str., 30, 634050,

E-mail: xeniya_ryabkina@mail.ru

The mathematical formulation of space-time energy release function of accelerated ions in solids is presented. Continuous focused ion beam interaction with metals is considered. The power density of deposited energy and specific energy input in a target has been calculated. A beam energy fraction expended on the collisional sputtering of target atoms has been estimated.

Today, accelerated ions are successfully used with a number of material processing technologies. Modern accelerating equipment allows generating ion beams with a wide range of particle initial energies and current densities.

However, the development of an energy efficient ion beam technology is accompanied by the control of a complicated dissipation energy process by choosing corresponding beam parameters. In the general case, there are several events of the input energy distribution. The beam energy can be expended on the atom sputtering, substance heating up, melting and evaporation. The energy dissipation structure mainly depends on a ratio between the energy release rate and energy distribution rate into a solid.

The given paper presents an approach to the mathematical description of the space-time energy release function (ERF) for the ion-solid interaction. Its calculation is a mandatory piece of the numerical simulation of thermal and erosion processes on a surface, computer modeling of the target deformation and destruction due to stress fields under the irradiation, and so on. The ERF of a continuous focused ion beam (CFIB) is considered here.

Suppose that ERF is additive that is the total amount of the energy deposited into a solid is a sum of the energy input of each ion at its stopping in the substance. Therefore, the calculation expression of the space-time energy release function $W(x, r, t)$ in two-dimensional geometry (Fig. 1) can be presented as follows:

$$W(x, r, t) = F(r, t) \cdot Q(x, t), (1)$$

where $F(r, t)$ – the ion flux distribution along the beam radius ($\text{ion}/(\text{m}^2 \cdot \text{s})$); $Q(x, t)$ – the distribution of linear energy losses along the target depth (J/m). In the general case, functions $F(r, t)$ and $Q(x, t)$ vary with time. Current and voltage oscillograms of ion sources (accelerators) contain the information about the time evolution of ion flux and ion energy.

In the present work, the ion energy spread is considered as negligible for CFIB, i.e. the function of

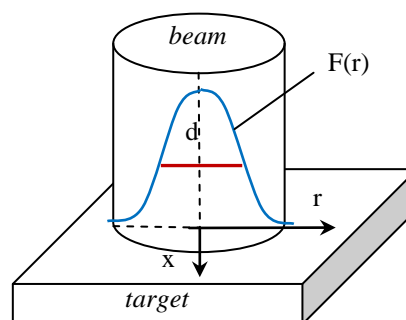

Fig. 1. Two-dimensional geometry of ion beam-target interaction

linear energy losses on a path unit travelled by ion $Q(x)$ is a time-independent. It realizes the calculation technique of the spatial distribution of ion energy losses with accounting nuclear and electronic stopping mechanisms [1]. This technique was developed according to the Lindhard-Scharff-Schiott theory [2].

Continuous irradiation technologies are characterized by low ion initial energies and deal with sputtering target from a solid state. CFIB parameters correspond to the following ranges: the ion initial energy $E_0 = 5-100 \text{ keV}$; the beam diameter $d = 5-1000 \text{ nm}$; the beam current $I_b = 10 \text{ pA}-30 \text{ nA}$ [3].

Since a focused ion beam diameter is commensurable to the projected ion range, its ERF must be calculated in two-dimensional geometry. To describe ion flux density along the radius of CFIB the way from [4] is used:

$$F(r) = \frac{I_b}{e} \cdot \frac{1}{2\pi\sigma^2} \cdot \exp(-r^2 / 2\sigma^2); \quad \sigma = d / \sqrt{8 \ln 2}$$

where I_b – the beam current (A), e – the elementary charge (C), r – the radial coordinate, the beam center is located at $r = 0$ (m), d – the beam diameter, commonly defined as the full width at half maximum (Fig. 1) (m).

The duration of CFIB action equals to units–tens of seconds; increasing and falling down fronts of $j(t)$ take inconsiderable part of irradiation duration. Therefore, suppose $j(t)=const$, i.e. the same number of particles fall down on a target surface per time unit.

Thus, Eq. 1 for CFIB is transformed into Eq. 2:

$$W(x, r) = F(r) \cdot Q(x). \quad (2)$$

The ERF of CFIB has been obtained for 10 keV Ar+ ions falling down on Al surface (Fig. 2). We have considered a beam with the diameter of 50 nm at the current of 10 nA . A beam focusing system allows increasing ion flux density, and the same values of energy input can be reached at much less initial energies.

The maximum of CFIB energy release power density W_m is observed in the central part of a beam (at $r = 0$ m) on a target surface. W_m decreases with increasing distance from the beam center according to Eq. 2.

Nowadays, ion beam technologies of micro- and nanoprocessing of materials mostly operate gallium liquid metal ion sources. It is mainly thanks to the low melting temperature of this metal ($29.77 \text{ }^\circ\text{C}$). So, maximal energy release power density has been calculated depending on the beam current I_b for Ga+ ions in comparison with Ar+ ions (Fig.2). The amount of deposited energy linearly increases at current growth. W_m of gallium ions is slightly more than W_m of argon ions.

A considerable growth of W_m results from the reduction of the beam diameter, i.e. with increasing beam current density. The beam compression by 100 times increases the energy release power density by 4 orders (Fig. 2).

The described above approach to ERF calculation does not account energy losses on collisional

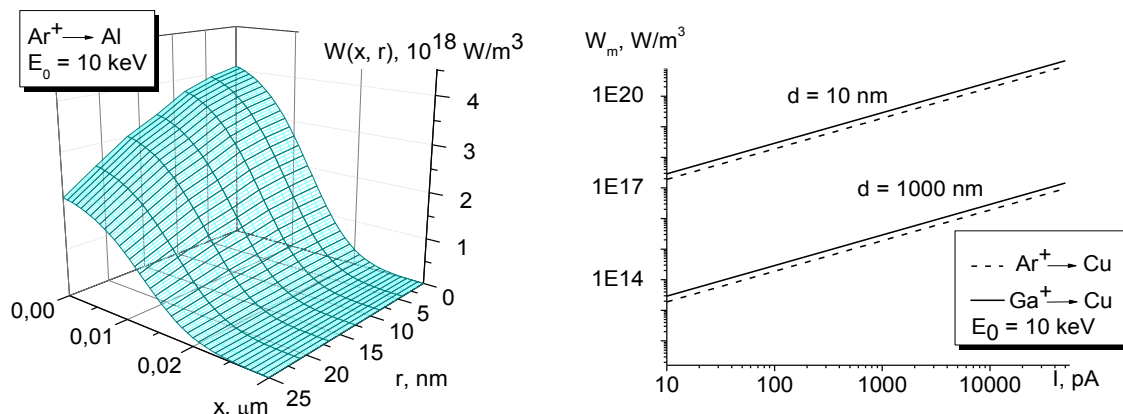

Fig. 3. The maximum of energy release power density depending on the CFIB current at the beam diameter 10–1000 nm (10 keV Ga+ (solid line) and Ar+ (dash line), target - Cu)

(physical) sputtering of surface atoms. Gallium ion mass is larger than argon ion mass ($M_{Ar} = 40 \text{ amu}$, $M_{Ga} = 69.77 \text{ amu}$). Energy expenditures on sputtering are expected to enhance. So, the calculation technique of energy absorption factor accounting the energy losses on collisional sputtering is given below. All the mathematical expressions conform to the SI system.

The energy absorption factor accounting the energy losses on collisional sputtering can be calculated through the expression:

$$\beta = \left(E_b - S \cdot E_1 \cdot \frac{1}{e} \int_0^{\tau} j(t) dt \right) / E_b$$

where E_b – the beam energy density (J/m^2), E_1 – the average energy of sputtered particles (J), S – the sputtering yield (*atom/ion*).

The variety of semi-empirical approaches to the calculation of sputtering yield and average energy of sputtered particles can be found in scientific literature. One of the ways of determining S and E_1 is set below.

At ion initial energies much more than the sputtering threshold energy ($E_0 \gg E_{th}$), the average energy of sputtered particles E_1 is calculated through the Falcone formula [5]:

$$E_1 = 2U_0 \cdot (\ln \omega - 3/2),$$

where U_0 – the surface binding energy, usually taken to be equal to the sublimation energy (J), $\omega = E_0/E_{th}$, E_0 – the initial ion energy (J), E_{th} – the sputtering threshold energy (J).

To determine S , the Sigmund formula for ions with $E_0 > 1$ keV was used [6]:

$$S = 4.2 \cdot 10^{18} \text{ (m}^{-2}\text{)} \cdot \frac{\alpha(M_2/M_1) \cdot S_n(E_0)}{U_0}$$

where α – the dimensionless function of the mass ration between the target mass M_2 and the ion mass M_1 , calculated with the Matsunami expression [7], $S_n(E_0)$ – the nuclear stopping power of target substance ($J \cdot m^2$).

To determine $S_n(E_0)$ according to the Linhard-Scharff-Schiott theory [2], the required set of formulae is given below (for the case of $10^{-4} \leq \varepsilon \leq 10^2$):

$$\varepsilon = E_0 \frac{a_T 4\pi\varepsilon_0}{Z_1 Z_2 e^2} \cdot \frac{M_2}{(M_1 + M_2)};$$

$$S_n(E_0) = \frac{a_T Z_1 Z_2 e^2 M_1}{\varepsilon_0 \cdot (M_1 + M_2)} \cdot S_n(\varepsilon); S_n(\varepsilon) = \frac{1.7\varepsilon^{1/2} \ln(\varepsilon + 2.718)}{1 + 6.8\varepsilon + 3.4\varepsilon^{3/2}} \quad (9)$$

where ε – the dimensionless reduced energy; $\varepsilon_0 = 8.85 \cdot 10^{-12}$ – the dielectric constant (F/m), $a_T = 0.4683 \cdot 10^9 \cdot (Z_1^{2/3} + Z_2^{2/3})^{-1/2}$ – the Lindhard screening parameter (m); Z_1 and Z_2 are the atomic number for the ion and target atoms.

The sputtering yield S and energy absorption factor β have been calculated depending on the ion initial energy in the range of 1–1000 keV. The results have been obtained for Ar+ and Ga+ ions incident on copper target with the maximal current density of 100 A/cm² (Fig. 4).

In the whole energy range, β is close to one, the amount of energy expended on sputtering does not exceed 4 %. The similar result of S calculation has been obtained for Ga+ ions with the calculator tool [8] (dash line in Fig. 4).

Hence, almost all the kinetic energy of falling ions is transformed into the substance internal energy. Energy losses on collisional sputtering are not considerable component in the energy dissipation structure, but to get the precious result they should be accounted.

The depth profile of energy release power density of accelerated ions in metal surface layer has a step-shape. The energy input depth is proportional to the ion projected range. Owing to focusing system, the ion flux density increases and the energy release power density reaches values $\sim 10^{21} \text{ W/m}^3$ at lower initial energies (tens of keV vs. hundreds of keV). The ion beam energy losses on collisional (physical) sputtering of a target are equal to units of percent.

REFERENCES

1. Gann V. V. and Yudin O. V., Questions of Atomic Science and Technology. Series: Physics of Radiation Damage and radiation materials Science [in Russian], 1 (9) (1979) 37 – 42.
2. Linhard J., Scharff M., Schiott H.E., Range concepts and heavy ion range, Mat. Fys. Medd. Dan. Vid. Selsk. 33 (1963) 33 (14) 1-42.

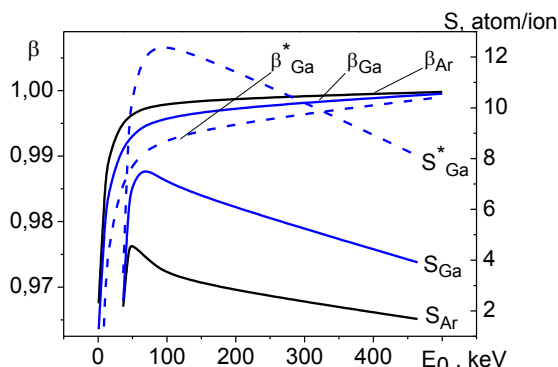

Fig. 4. The energy absorption factor and sputtering yield depending on the initial energy of Ar+ and Ga+ ions falling down on copper surface (— — the present paper result; - - - - the result obtained with [8])

3. Suutala, Focused ion beam technique in nanofabrication, The Meeting of National Graduate School in Nanoscience 2009, from https://www.jyu.fi/science/muut_yksikot/nsc/en/studies/ngs/course/meeting09/.
4. Ertl O., Filipovich L., Selberherr S., Three-dimensional simulation of focused ion beam processing using the level set method, International Conference on Simulation of Semiconductor Processes and Devices (SISPAD 2010), Bologna, 03-B.2 (2010) 49-52.
5. Falcone G., Sputtering transport theory, Physical Review B 38 (1988) 6398-6401.
6. Sigmund P., Theory of sputtering I. Sputtering yield of amorphous and polycrystalline targets, Physical Review 184 (1969) 383-416.
7. Yamamura Y., Matsunami N., and Itoh N., Theoretical studies on an empirical formula for sputtering yield at normal incidence, Radiation Effects 71 (1983) 65-86.
8. A simple sputter yield calculator by Michael Schmid.
(<http://www.iap.tuwien.ac.at/www/surface/sputteryield>).

INFLUENCE OF THERMOPHYSICAL PROPERTIES OF THE SOLID DEPENDENCE FROM TEMPERATURE ON THE THERMAL CHARACTERISTICS AND EROSION UNDER THE ACTION OF HIGH-POWER PULSED ION BEAMS

R.P.Truntseva

Scientific Supervisor: Dr. G.A.Bleykher

Linguistic Advisor: Senior teacher N.V. Demyanenko

Tomsk Polytechnic University, Russia, Tomsk, Lenin str., 30, 634050

E-mail: rusenochka@gmail.com

This paper presents data on the evolution of erosion, melting, evaporation of matter under the influence of powerful pulsed beams of carbon ions. The calculations of dependence of physical characteristics on the temperature are performed. Considered current density 300-1000 A/cm² at an initial energy of the beam particles equal to 300 keV, and 70-140 A/cm² for the initial energy of beam particles equal to 1 MeV. Correct cases of neglecting dependencies on temperature are established.

INTRODUCTION

Action of powerful pulsed beams of charged particles with matter leads to significant changes in its properties, which cannot be produced in other ways. They are commonly used in the technologies, based on surface modification.

Modifying effect of powerful pulsed beams caused by high heating of thin surface layers up to the phase transition temperatures. So it is important to have an understanding of thermal processes evolution. Mathematical modeling plays an important role here. There was created a number of models describing the behavior of matter under the influence of powerful pulsed beams of charged particles [1]. Usually calculations of the temperature fields, the amount of vaporized and melted substance is produced using thermal characteristics that do not depend on temperature [2-4]. The approach is correct, if it is required to study the behavior of the characteristics on a qualitative level, without requiring great precision to the obtained values.

Recently there was a demand to solve problems when we need to know the evolution of processes with a high degree of accuracy; for example, to model structure and phase composition of matter or to identify optimal technological parameters of processing material. In this case, solutions without dependency on thermal conductivity and the heat capacity cannot satisfy the requirements. Therefore the purpose of work, the results of which are presented in this article is to provide a numerical model of heat and erosion processes in solids under the action of pulsed beams, which takes into account the dependence of the thermal characteristics of the temperature. With its help we investigated discrepancy between the results of calculations performed with and without dependent physical characteristics of the temperature for different beam parameters and target materials.

MATERIALS AND METHODS

Was used the model of energy dissipation, developed in [1]. Dimensional model of heat and erosion processes in a solid body has the following form:

$$\frac{\partial E(x,t)}{\partial t} - \nu(T) \frac{\partial E(x,t)}{\partial x} = \frac{\partial}{\partial x} \lambda(T) \frac{\partial T(x,t)}{\partial x} + \frac{W(x,t)}{C(T)\rho(T)}, \quad (1)$$

here E is thermal component of internal energy, ν - rate of evaporation front, $W(x,t)$ is the space-time function of

energy release when the beam particles come to a stop in the irradiated substance. In its turn, the function of energy release looks like:

$$W(x,t) = \frac{1}{e} j(t)G(x), \quad (2)$$

where e is electron charge, $j(t)$ - temporal distribution of current density pulse, $G(x)$ - spatial distribution of linear energy losses during the passage of a single ion with an initial energy E_0 through the matter.

The boundary and initial conditions are imposed to equation (1):

$$\begin{cases} \lambda(T) \frac{\partial T}{\partial x} \Big|_{x=0} = \nu(T) \rho(T) \Delta H, \\ \lambda(T) \frac{\partial T}{\partial x} \Big|_{x=x_{end}} = 0, \\ T(x,0) = T_0 = 300K, \end{cases} \quad (3)$$

where ΔH is the difference between the enthalpy of the vapor and condensed phases.

There was used developments of $C(T)$ and $\lambda(T)$ from [7] (Fig.1,2 – line 1) – on example of copper.

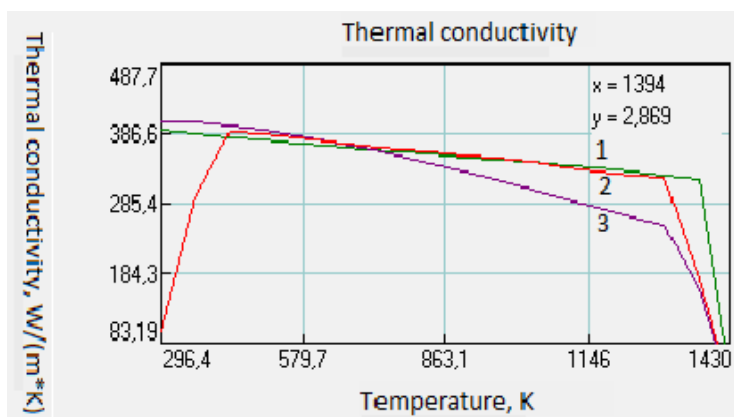

Fig.1. Dependence of thermal conductivity of copper on temperature (1 – [7], 2 – [6], 3 – [5]).

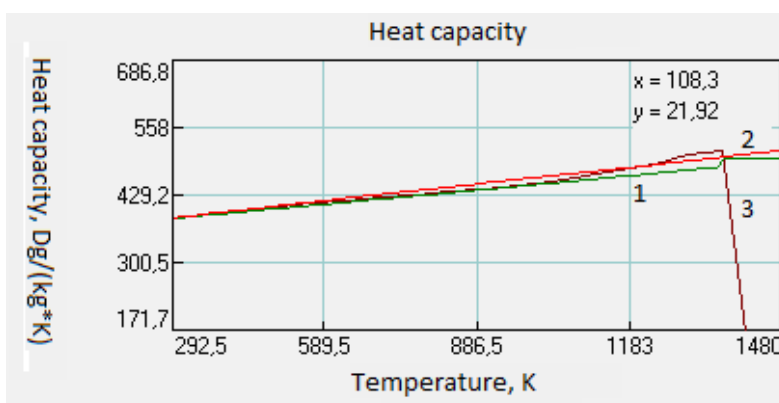

Fig.2. Dependence of heat capacity of copper on temperature (1 – [7], 2 – [6], 3 – [5]).

Account the dependence of the density of matter on the temperature did not occur because it is virtually constant for the investigated range of beam parameters.

ANALYSIS OF THE DATA

We considered carbon ion beams, 100 ns with an initial energy of 300 keV and 1 MeV. We modified existing program modeling the dynamics of basic processes occurring under the influence of powerful pulsed beams of charged particles with matter by dependencies of thermal conductivity and heat capacity.

The calculations are performed for silver, iron, aluminum and copper at change of current density j in the beam from 300 A/cm^2 to 1000 A/cm^2 at the initial particle energy $E_0 = 300 \text{ keV}$ and for j from 70 A/cm^2 to 490 A/cm^2 at $E_0 = 1 \text{ MeV}$.

Calculations were performed for thickness of the evaporated layer, the lifetime of the liquid phase, the erosion coefficient and the thickness of the molten layer.

The article presents the data on the thickness of the evaporated layer and the lifetime of the liquid phase for aluminum and iron in the initial beam energy $E_0 = 300 \text{ keV}$ (Fig. 3, 4). It also presents data on the difference in the results of calculations obtained taking into account the dependence of thermal conductivity and specific heat on temperature, and without it. The difference was calculated as:

$$\frac{|M_{with} - M_{without}|}{M_{with}} \cdot 100\%.$$

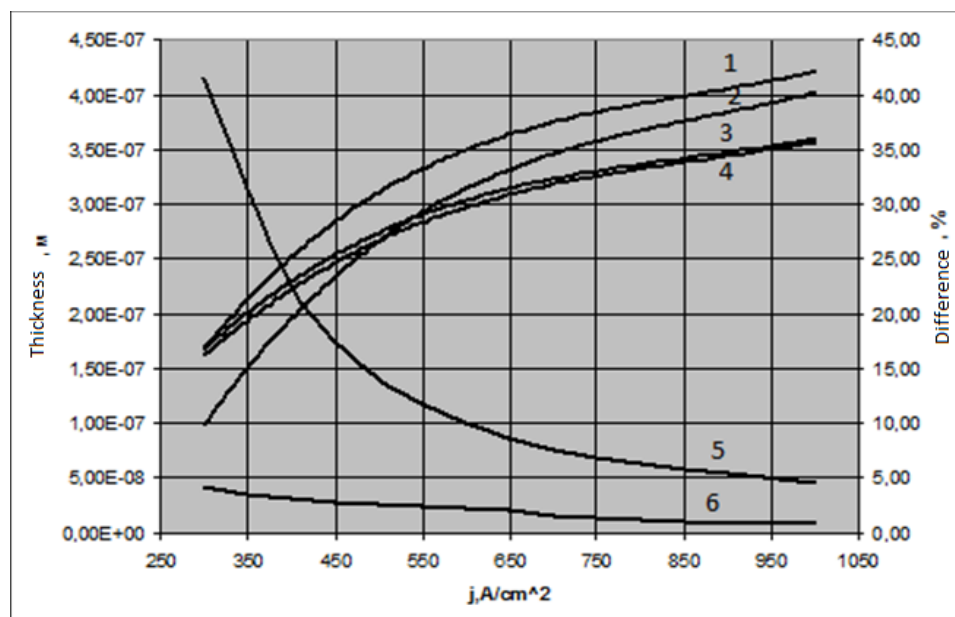

Fig.3. Dependence of the thickness of the evaporated substance layer on the current density (1 – Ag considering dependence, 2 – Ag without dependence, 3 – Fe considering dependence, 4 – Fe without dependence, 5 – difference between 1 and 2, 6 – difference between 3 and 4).

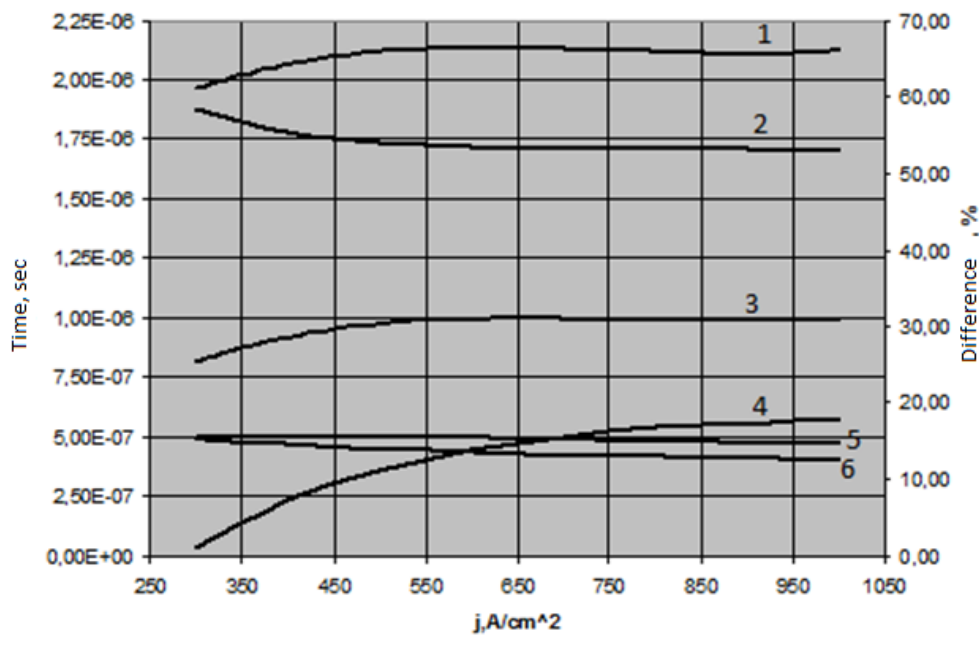

Fig.4. Dependence of liquid phase lifetime of a substance on the current density (1 – Ag considering dependence, 2 – difference between 1 and 3, 3 – Ag without dependence, 4 – difference between 5 and 6, 5 – Fe without dependence, 6 – Fe considering dependence).

The biggest difference observed at low current densities. In the case of silver, it reaches 40% of the thickness of the vaporized layer and 60%; for the lifetime of the liquid phase for the iron - 5% and 18% respectively.

By increasing the current density difference is stabilized. At the same time the thickness of the evaporated layer is decreases with increasing j , the values for the lifetime of the liquid phase in the case of silver - reduction, and for iron - increase.

Higher differences in calculating the thickness of the evaporated layer and the lifetime of the liquid phase are performed with and without thermal properties of irradiated materials, in the case of silver compared with iron explained as follows. The coefficient of thermal conductivity of silver is significantly higher than iron. Hence the contribution of thermally conductive flow in the energy balance in the surface region of the target is greater. Accuracy of the calculation of a heat sink affects the final result.

The higher the current density, the faster the evaporation is. Besides, as the temperature increases the thermal conductivity falls. Therefore, at high current densities difference in the thickness of the evaporated layer is less.

For aluminum, the difference in the values of the thickness of the evaporated layer was smaller, but for the lifetime of liquid phase it is in the range of 30-35% throughout the observation interval.

CONCLUSION

When metals are exposed to powerful submicrosecond pulse ion beams of duration of 100 ns in the low current the density difference (the existence of a liquid phase, the thickness of the molten layer) is significantly higher than in the range of high- j .

For metals with high thermal conductivity (silver, copper, etc.) in the modeling of thermal and erosion processes under the influence of submicrosecond carbon ion beams it is required to consider changing of thermal

conductivity and the heat capacity. For substances such as iron, neglecting of dependence of thermophysical characteristics on the temperature is justified.

REFERENCES

1. G.A.Bleykher, V.P.Krivobokov, The regularities of solid surface erosion and coating deposition using high-power pulsed beams of charges particles//Nuclear instruments and methods in physics research b – 292 (2012) 14-39.
2. G.A. Bleykher, V.P. Krivobokov, O.V. Pascenco, Thermal processes in solids under the influence of powerful pulsed beams of charged particles / / Proceedings of Tomsk Polytechnic University, Tomsk Polytechnic University (TPU). - 2000. - Т. 303, vol. 2: Radiation Physics of Solids and radiation technologies. - [P. 71-91].
3. G.A. Bleykher, V.P. Krivobokov, Theoretical Foundations processing pulsed electron and ion beams: Tutorial, Tomsk Polytechnic University (TPU). - Tomsk: TPU in 2009. – p.216.
4. G.A. Bleykher, V.P. Krivobokov, O.V. Pascenco, Heat and mass transfer in a solid under the influence of powerful beams of charged particles, Nauka, Novosibirsk, 1999. – p.176.
5. V.E. Zinoviev, Thermophysical properties of metals at high temperatures, ref. ed., M.: Metallurgy, 1989. p.384.
6. N.N. Rykalin, A.A. Angles, I.Y. Smurov, Calculation of nonlinear problems of laser heating of metals / / Impact of concentrated energy fluxes on materials / processes Thermophysics heating materials - Moscow: Nauka, 1985.
7. Z.G. Wang, Ch Dufour, E Paumier, M Toulemonde, The Se sensitivity of metals under swift-heavy-ion irradiation: a transient thermal process//Phys.: Condens. Matter 6(1994) 6733-6750.

СЕМНАП
INNOVATIVE TRENDS FOR MODERNIZING ENGINEERING IN THE AGE OF GLOBALIZATION

EXTRACTION OF THE THERMONUCLEAR ENERGY

A.A.Bulavinov, A.A.Serenko

Scientific Supervisor: A.V.Obhodsky

Language Advisor: Senior teacher O.P. Kabrysheva

Tomsk Polytechnic University, Russia, Tomsk, Lenin str., 30, 634050

e-mail: andrewmoonlight@yandex.ru

Annotation

The problem of the energy shortage requires new methods of the energy generation. The explosive deuterium energetics based on the thermonuclear fusion is one of them. In the paper the new theoretical method of energy generation with small thermonuclear explosions in a special building, which was considered by Russian scientists in «The explosive deuterium energy» is analyzed.

Key words: *deuterium, thermonuclear fusion, flare combustion boiler, explosive deuterium energetics, thermonuclear explosion, energy shortage, theory.*

Introduction

One of the most important problem of the XXI century is shortage of energy. Modern energy sources provide the humanity needs, but generation of energy is still very expensive and has a bad influence on the environment. Lack of the basic energy sources such as coal and oil makes the humanity search the new, available and environmentally friendly sources of energy. Due to this fact the mature economies started to introduce some technologies for reducing energy consumption. In the last quarter of the XX century the application of some special technologies in the industrial production of the other national economies helped to halve energy consumption in America and Germany.

Despite this, the future development of the countries requires more and more energy. The developed countries started to compete for the last stocks of the energy sources. Limited reserves of the basic energy sources such as coal and oil make the humanity search the new, available and clear sources of the energy.

Thermonuclear explosion is one of the alternative eco clear energy sources. It is the source of energy which humans have not controlled yet. Nowadays the controlled thermonuclear fusion has not applied in industry because of the serious technological problems. One of the problems is a process of tritium mining, which does not exist in nature. In this article the theory of the uncontrolled thermonuclear explosion as a solution of the energy shortage problem is presented.

Objectives:

- To analyze ways of application the thermonuclear technologies for industrial generation of energy.
- To attract the attention of young specialists to research work in the field of application of the thermonuclear technologies.

Tasks:

- To make an analytical review of literature.
- To analyze the technologies, which have already been used in to produce the thermonuclear energy.

Development

Deuterium is an isotope of hydrogen with two neutrons in the core. It is an environmentally friendly, cheap, available and unlimited fuel, as it can be obtained from water. The amount of energy obtained with thermonuclear fusion from 1 kilo of deuterium is equivalent to the amount of energy obtained from 104 tons of oil. The idea of the explosive deuterium energy is based on getting energy from the explosions of special «energy charge». In this paper the method of generating thermonuclear energy, offered by Russian scientists in «The explosive deuterium energy», is considered. ^[1]

[1]

However the using of explosive technologies for peaceful purposes is not new. The small explosions of the patrol in the engine of internal combustion make the car move. The nuclear explosions for the autopsy soil and oil exploration were widely used in the USSR in the second part of the XX century. ^[2]

There are the special flare combustion boilers(FCB) which are supposed to produce energy from the thermonuclear explosions. The calculation of the construction of BFC is based on the great experience obtained from the underground nuclear tests.

The boiler of the flare looks like a big reinforced concrete barrel 150 meters in diameter, 250 meters in height. The walls are 35 meters thick and they are covered with the 20 centimeters steel layer. The boiler is strewn under the hundreds meters of the ground. It is possible to get 37 gigawatt of the thermal energy every half an hour in pulse mod with the deuterium explosions equivalent to 10 kilotons of the TNT. It is equivalent to approximately 25 million tons of oil.

The energy and the impulse of the thermonuclear explosion are absorbed by the falling layers of the liquid sodium and after that there is a process which is the similar to that at the nuclear stations. According to the calculation the boiler will produce over 2 million kilowatt electrical and 4 million kilowatt of thermal power every half an hour with the explosions of the charges in 3 kilotons of TNT equivalent. Theoretically every BIC will pay for itself in one or two years and will serve for over 50 years.

The veil of liquid sodium provides the heat exchange and helps to protect the steel layer from the blast wave and eradiation. An average temperature of the sodium will be over 550 degrees centigrade. The temperature after each explosion will increase by several tens times and will fall with heat exchange. Sodium must be separated from the radioactive unreacted materials, the parts of the exploded charges, fission fragments, and then it has to be returned to the fuel cycle. The thorium and uranium blankets may be irradiated with the thermonuclear neutrons for reproduction of fissionable materials.

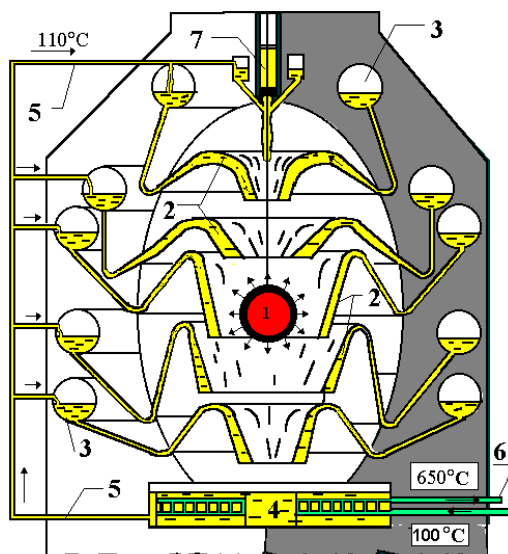

Pic2. The theoretical scheme of the flare combustion boiler

1 – blast wave, 2 – protective wall of the falling sodium, 3 - balloons with the cold sodium(50 C), 4 - the sodium heat transfer agent, 5,6 – the first and the second outlines of the heat exchange, 7 - the elevator for the dawn of the energy charge

The detonation of the deuterium charges is to done with the energy from the fission chain reaction of less than 100 grams of U-233 or plutonium. It is possible to create more fissionable material with the strong thermonuclear neutrons in a special blanket Th/U than it is necessary for the detonation.

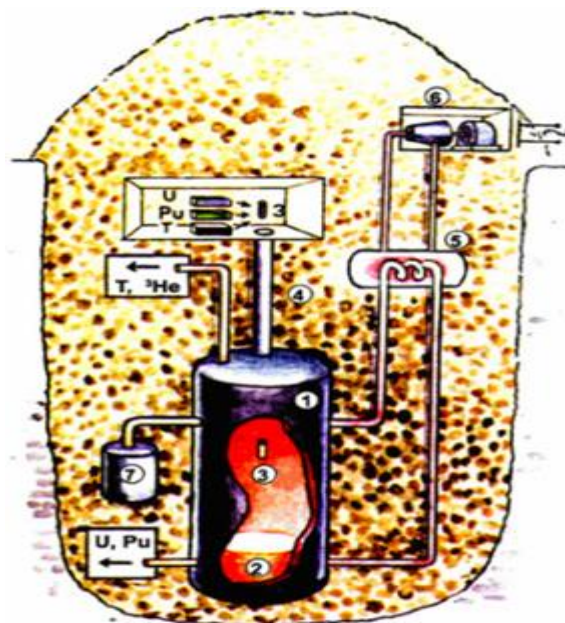

Fig 1. The technological scheme of the energy generation cycle in the FCB

The technological process of electricity production in FCB may be presented as a scheme as it is shown on Fig. 2. A few ten thousand tons of the liquid sodium 2) is put into the steel boiler 1). The charge 3) is made from several parts and put down through the special channel 4). After the explosion the liquid sodium comes to heat exchanger 5) where the water steam under the great pressure is produced. The steam turns the turbine 6), which is connected with the electrical generator. There is a special room 7) for the fragments from the fission. Unreacted fuel (U, Pu) and also the products of the reaction (H-3, He-3) are getting to the recast.

Nowadays the idea of the industrial application of BFC is far from its implementation. It is presented only in theory and it has a lot of technological problems, however, not long ago nuclear a station was just a project.^[3]

Conclusion

The construction of one BFC will cost about 600 million dollars and expenses on the explosion control will be about 150 million dollars/kiloton, which doesn't include the cost of technological equipment (its cost is proportional to generated power). At first there was an idea of FCB construction with energy of explosion from 10 to 50 kilotons, but now BFC with power of explosion of 100 kilotons seems to have more advantages. Presented idea of energy generation from thermonuclear explosions, if implemented, stands a good chance to solve the problem of energy shortage in the world. Hypothetically, FCB also can be used for radioactive wastes disposals from the nuclear station, bacteriological and chemical weapon.^[3]

References:

1. Ivanov G.A. The deuterium explosive energy/G.A. Ivanov, N.P. Voloshin, A.S. Ganeev, F.P. Krupin, S. Yu. Kuz'minykh, B.V.Litvinov, A.I. Svalukhin, L.I. Shibarshov.- Snezhinsk.: publishing house RFNC-ARRITP,2004.-288p.
2. The peaceful nuclear explosions in the USSR [The electronic resource]. - <http://ru.wikipedia.org/>. – (date of watching:25.03.2014).
3. Parafonova V. The explosive energy instead controlled thermonuclear fusion [The electronic resource].- <http://www.nkj.ru/archive/articles/4460/> .(date of watching:26.03.2014).
4. The controlled thermonuclear fusion [The electronic resource].- http://ru.wikipedia.org/wiki/Управляемый_термоядерный.. . - (date of watching: 25.03.2014).
5. Lukashin G. Unprofessionalism as qualificatory system sign of suitability [The electronic resource]. - <http://nuclear.tatar.mtss.ru/fa131106.htm> . - (date of watching: 25.03.2014).

DETERMINATION OF OPTIMAL CONDITIONS THE PHASE TRANSITION FOR INDUSTRIAL UNIT FOR PRODUCTION OF TUNGSTEN HEXAFLUORIDE

S.V. Chernigovskiy

Scientific Supervisor: PhD Smolkin P.A.

Linguistic Advisor: Teacher Shaykina O.I.

Tomsk Polytechnic University, Russia, Tomsk, Lenin Avenue, 30, 634050

E-mail:chernigovskiy.s@mail.ru

ABSTRACT

A mathematical model has been developed to calculate the optimal temperature of desublimation metal fluorides and the number of stages desublimation that allows bring the recovery of the desired product from the gas mixture to almost 100%. Experienced test results have been obtained with desublimation of tungsten hexafluoride and tungsten that showed a good convergence with theoretical data. The proposed method of calculating the parameters of the process desublimation can be applied to similar calculations desublimation processes (condensation) of other substances, for maximum efficiency.

Key words: *phase transitions, condensation and desublimation, volatiles metal fluorides*

Introduction

In the technology of getting a number of pure substances and intermediates, including technology and nuclear fuel, sublimation-desublimation redistribution is of particular importance being a refiner operation. All the existing methods for allocating desublimers solids from the gas stream can be divided into three groups: surface, volume and mixed. [1] However, these devices have a significant disadvantage that is a low yield in desublimat main product (70 ... 90%), the cause of which is the formation of aerosols at strong supercooling steam desublimating substances and their entrainment from the system.

In industrial processes of condensation and desublimation VF_5 , ZrF_4 , TiF_4 , WF_6 , UF_6 , ReF_6 , and other volatile metal fluorides are usually conducted at temperatures which are considerably below the initial temperatures of desublimation that causes formation of nuclei in the bulk nucleation device and as a consequence, the loss of a product in the form as aerosols. For example, at titanium tetrafluoridedesublimation, the reduction of sublimation temperature below the initial of 250° gives fluffy, crystal desublimat of a needle type; 150° - the layer of a bulk material partially covered with elastic film; 100° - solid glassy product throughout the layer. Thus, the loss of the product at the outlet of desublimator comprised 27, 12 and 5% wt. respectively. Therefore the greatest desublimation effective way would be the one in which the process of aerosols appearance has been able to suppress in a changing thermal conditions and monitor the growth of the layer desublimat, while maximizing the filling of apparatus and its permeability.

The purpose of this work is to determine the conditions of supersaturation and the critical supersaturation of tungsten hexafluoride, as well as the influence of these parameters on the process of condensation (desublimation).

Development, methodology.

The process of hexafluoride desublimation metals significantly affect the temperature of cold surfaces

apparatus, partial pressures of the components of the process gas, the physical chemical properties of the components of the gaseous mixture, as well as a number of other factors.

In this paper we proposed and tested a method for calculating the temperature of the condensation process (desublimation) of tungsten hexafluoride, ensuring maximum yield in the condensed phase and minimal losses in the form of aerosols.

1) Calculation of temperature desublimation.

The degree of supersaturation of the vapor-gas mixture essentially depends on the difference between the temperatures of the gas-vapor mixture entering the apparatus and a surface desublimator. If we denote the temperature of the gas mixture entering the desublimator through T_1 , "cold" surface - T_2 , the distance that takes gas mixture, cooling at the temperature from T_1 to T_2 , is l , then, assuming that as the distance x from the entry point of gas into the machine to the exit point of the gas mixture has a temperature T to decrease linearly from T_1 to T_2 . It is obtained:

$$T = T_2 + \frac{T_1 - T_2}{l} \cdot x. \quad (2.24)$$

Then the pressure P changes in a similar manner

$$P = P_2 + \frac{P_1 - P_2}{l} \cdot x. \quad (2.25)$$

Degree of supersaturation S can be calculated as follows:

$$S = \frac{P_T}{P_{\infty(T)}}, \quad (2.26)$$

Where, $P_T, P_{\infty(T)}$ is a vapor pressure drop over and above the flat surface of a desublimating substance.

Substituting the values of pressure and temperature in the expression (2.26), we can define the degree of supersaturation at a given temperature

$$S = \frac{T - T_2}{T_1 - T_2} \cdot \frac{P_1 - P_2}{P_{\infty(T)}} + \frac{P_2}{P_{\infty(T)}}. \quad (2.28)$$

A significant role in the processes of tungsten hexafluoride desublimation plays the heat exchange between the gas and the cooled surface. Coolant Temperature usually remains constant with increasing desublimat layer having a high thermal resistance (low thermal conductivity), the surface temperature desublimation increases and the desublimation degree decreases monotonically. Therefore desublimation of hexafluorid tungsten is carried out on a moving surface in unsteady conditions. For the stabilization process, the heat removal from the gas mixture and, in fact, different methods use various methods of cleaning the surface from desublimat (scrapers, thermal sludge of discharge, etc.).

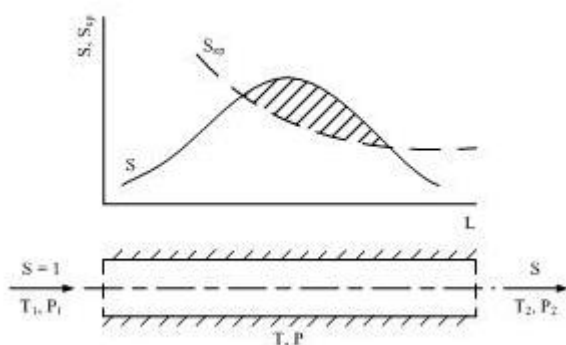

Figure 2.1 - Change of supersaturation of the vapor stream when moving through the pipe.

Speed ratio of mass transfer and heat transfer are such that the supersaturation increases initially, reaches a maximum and then decreases. In the region where it exceeds the critical value (hatched portion), the volumetric desublimation flows. If mass transfer predominates over the heat exchange, the tungsten hexafluoride diffuses the deposit before the gas mixture cools. Then supersaturation does not reach a critical value and the volumic product desublimation from gas mixture does not occur. If the stage of heat exchange is dominated, then the desublimat does not have an opportunity to diffuse to the surface of desublimation and the dominant process is the volume desublimation. For heavy molecules of tungsten hexafluoride, second model desublimation probability are much higher.

2) The rate of nucleation.

The work spent on the nucleus (equal change in the free energy), is formed by the work of transfer of particles from the gaseous phase in a liquid or solid (in the case of a supersaturated vapor, this work will be negative), and work related to the formation of the nucleus. For the complex located in unstable equilibrium with the available supersaturated vapor, the total work of formation is associated with Gibbs energy:

$$\Delta G = \frac{1}{3} \sigma F, \quad (2.36)$$

where F is surface of forming phase m^2 .

for spherical drops

$$F = 4\pi r^2, \quad (2.37)$$

therefore, substituting the value of F in (2.36), we obtain:

$$\Delta G = 4/3 \pi r^2 \sigma. \quad (2.38)$$

$$\Delta G = \frac{16\pi n^2 \sigma^3}{3\rho^2 \kappa^2 T^2 (\ln S)^2}. \quad (2.39)$$

2) Criterion determining the nature of the process desublimation.

The question of where desublimation product takes place on the surface or in the bulk desublimator of vapor-gas mixture is determined by the ratio of speeds heat and mass transfer desublimating product that can be

evaluated using the criterion of Lewis Le

$$Le = \frac{\alpha_{\dot{m}}}{c_{p\dot{m}} \rho_{\dot{m}} \beta}$$

where

α_{cm} - heat transfer coefficient, $\text{kJ} / (\text{m}^2 \cdot \text{h} \cdot \text{K})$;

c_{pcm} - specific heat of the gas-vapor mixture, $\text{kJ} / (\text{kg} \cdot \text{K})$;

ρ_{cm} - gas mixture density, kg / m^3 ;

β - mass transfer coefficient, m / h

If Le is under these conditions is greater than one, then the heat transfer rate is higher than the intensity of a mass transfer. As a result, the desublimating product does not have time to be delivered to the surface in the form of steam, so the predominant is process of a volume desublimation. In view of the difficulty of determining the coefficients of mass and heat transfer for the various conditions of the organization of the process, criteria values Lewis hardly is not almost applicable to assess the effectiveness of the process.

The presented analysis of tungsten hexafluoride desublimation process allows us to identify those groups of parameters that determine, ultimately, its effectiveness, and to understand the mechanism of the process. However, these relationships as well as in most of the heat and mass transfer processes are not always applicable for practical design calculations of the desublimator and its parameters because of the difficulty of determining the coefficients of heat and mass transfer in terms of constant characteristics of the fluctuations of heat transfer surface, and the flow of the initial gas mixture. Therefore, to determine the optimum processing characteristics and parameters of desublimator their experimental verification is required, both at the stage of individual elements of machines and structures as a whole, drawing on mathematical modeling.

Modeling of the condensation process (desublimation) of tungsten hexafluoride

As above, to eliminate the bulk desublimation it is necessary that the magnitude of the degree of supersaturation is close to the critical value, but does not exceed its entire range of temperature from a temperature of the sublimation of the substance (gas flow entrance temperature to desublimator) to a temperature coefficient at any desublimation.

The temperature of the cold wall, that is desublimating surface temperature, is in the condition that it must be the lowest temperature at which the volume desublimation is excluded but ensured the maximum temperature difference between the temperature of the incoming gas in desublimating camera (or a hot surface desublimator) and a cold surface, causing the maximum rate of sublimation processing.

To determine these conditions, a computer program has been developed. The results of calculations for the desublimation process of tungsten hexafluoride are shown in Table 2.5

Table 2.5 - Calculation of temperature the desublimation tungsten hexafluoride provided $S = \text{Skr}$

hot wall temperature, K	cold wall temperature, K (°C)	supersaturation degree	aerosols mass concentration, g/cm ³	capture degree, %	residual pressure WF ₆ , mm Hg.
The first stage of desublimation					

333	264 (-9)	3,5	0,0098	71,4	217
The second stage of desublimation					
333	241 (-32)	5,3	0,0035	81,1	41

The total capture degree of tungsten hexafluoride after two stages of condensation is equal to 94.6%.

Results

Desublimated purification of tungsten hexafluoride from impurities is the least researched stage of the production technology of fluoride. Therefore, the results should be considered as one of the stages of development of this technology. Studies show the effectiveness of the use of desublimation processes for extraction of tungsten hexafluoride from the process gas generated after its synthesis by the gas fluoride technology.

Analytical calculations establish that at the hot wall temperature of the vessel (inlet temperature of gas in the desublimation area) 333 K (333 K) the calculated value of the surface temperature of sublimation (hot surface) of tungsten hexafluoride is 333 ... 293 K.

The cold surface temperature at tungsten hexafluoride desublimation should be maintained within 253 ... 245 K, because at such a high temperature desublimation residual pressure of tungsten hexafluoride is large 217 mm Hg. and it may lead to the loss of the product due to aerosol formation and their entrainment from the system. Therefore, the second step of desublimation is required.

To prevent the formation of aerosols the minimum temperature of tungsten hexafluoride desublimation at the second stage should be 241 K. The residual vapor pressure of tungsten hexafluoride at this temperature is small (41 mm Hg. Tbsp.), so the loss of the product would be negligible - 0.0035 g/cm³, which allows get the product outlet in the desublimat at I and II stages of the desublimation 0.95.

Conclusion

In this paper the role of the desublimation processes in the industry is considered in general and radiation area in particular. The critical parameters of tungsten hexafluoride have been calculated, such as temperature, a specific volume, a density and a compressibility factor.

A mathematical model has been developed to determine the conditions of critical supersaturation of metal fluorides and conditions excluding the formation of aerosols at the desublimation. The program for determining these conditions has been created.

References

1. AG Gorelik, A.V. Amitin (1986) Desublimation in the chemical industry . - Moscow: Khimiya , 272 .
2. Pishchulin V.P, V.P Trochkine (2000) Processing of weapons-grade uranium into fuel for nuclear power plants Energy: Textbook. - Seversk TPU Publisher, 36.
3. Technical Dictionaries (1998). Editorial Board: A. ISHLINSKII (Editor), etc. - 3rd ed. rev. and add. M.: «Great Russian Encyclopedia», 656 p.
4. Klogina L.I., Chekhov A. Bulatov S.N. etc (1975). Mass crystallization. - Moscow: IREA, (1975), № 1, 119 p.
5. Buynovskiy A.S., Sofronov V.L., Rusakov I.Y. (1987) Calculation - sublimation desublimatsionnyh devices. - Tomsk: TPI, 121.

6. Buynovskiy A.S., Velikoselsky N.D., P.A. Smolkin (1999) Computer calculations of the nucleation rate, growth and deposition of particles: A Practical Guide for Students. - Seversk STI TPU, 29 p.
7. Hausen H. (1981) Heat transfer in countercurrent, cocurrent and cross- currents: Per. from English. Énergoizdat, 383 p.
8. Volinets A.Z., Skachko A.M., A.V. Chernyak (1984) and other continuous process of sublimation purification dispersion of substances // Theoretical Foundations of Chemical Engineering, V. 15, № 5. S.615.
9. K.P. Shumsky (1974) Vacuum apparatus and instruments chemical engineering. - M.: Mechanical Engineering, 576.
10. Pat. (1960) 93773 Czechoslovakia MKI3 In 01 D 7/00. Sublimation apparatus for cleaning substances: Publ

STUDYING OF MORPHOLOGY AND ELEMENTAL COMPOSITION OF THE CALCIUM PHOSPHATE LAYER AFTER TREATMENT BY IMPULSE ELECTRON BEAM.

E.A. Chudinova, M.A. Surmeneva, I.Yu. Grubova, N.S. Pushilina, A.D. Teresov

Scientific Supervisor: PhD, Ass. Prof. R.A. Surmenev,

Linguistic Advisor: Teacher A.V. Tsepilova

Tomsk Polytechnic University, 634050, Russia, Tomsk, Lenin str., 30

E-mail: e_chudinova93@mail.ru

One of the effective ways to improve the adhesive properties of biocompatible coatings on implants is using electron-beam melting of the surface, accompanied by a partial or complete mixing area "coating- substrate". The surface of the titanium substrate bearing calcium phosphate coating received by RF magnetron sputter is processed by a pulsed electron beam having an energy density of 0.8 - 8 J/cm². After treatment by a pulsed electron beam under different regimes significant changes in the topography of the formed surface were observed. Treatment regimes with an energy density of 0.8 J/cm² and 3 lead to the thermal annealing of the coating. The use of a beam having an energy density of 8 and 6.5 J/cm² leads to partial vaporization and mixing of the coating material with a titanium matrix.

Currently, studying materials in the field of medical supplies is a very promising direction in science [1-2]. Modification of the surface by forming biocompatible coatings of different thicknesses is the most common method used in industrialized countries. Development of new materials, creation of thin solid, durable coatings (on the developed surface of the implant) is of considerable interest nowadays.

Ideally, the material should be biocompatible with the tissue, that is, to cause an adequate response, not be toxic, not cause adverse immune reactions and of the body. It should not be rejected by the body as an external body and be biologically active, that is, it should come into direct contact with biological system of the body and induce bone formation processes. At the same time, implants should maintain their functional qualities [3]. This problem was solved by using materials based on calcium phosphates biocompatible with the tissues of the body, characterized by activity of the compound towards bone tissue and the formation of new bone tissue. It represents the unique possibility of using calcium phosphate as a coating material for implants [1].

However, at this stage of development problem of destruction of the coating when it is placed in liquid biological environment, i.e. cracks that reach the interface "coating- substrate" remains unsolved in biomedicine [4]. One effective way to solve this problem is proposed by several authors [5, 6]. It is the use of electron-beam melting of the surface, accompanied by a partial or complete mixing area "coating- substrate", which will give an opportunity to get a high adhesive strength [7].

In this regard, the aim of this work is to study the morphology and elemental composition of calcium - phosphate layer after treatment by pulsed electron beam.

Deposition of silicon-based coatings of hydroxyapatite (Si-HA) was produced using an industrial installation COMDEL with magnetron source (13.56 MHz). The distance between the substrates and magnetron source is 40 mm, the RF power is 500 W, the pressure of the working gas is 0.1 Pa working gas is argon and deposition time is 8 hours. Preparation and studying of powder and spray targets is presented in [8].

Commercially pure titanium VT1-0 most often applicable in medicine is used as the material for substrate. Irradiation of surface of the samples was carried out on the vacuum impulse electron beam (IEP) installation "Solo" (Institute of High Current Electronics SB RAS, Tomsk, a team led by Koval N.N.). Irradiation was carried out by electronic pulses of duration $\tau = 50$ ms (number of irradiation pulses $N = 3-50$, repetition frequency $f = 0,3-5$ Hz) with an energy density $E_s = 0,8-8$ J/cm². Irradiation modes of the samples are given in Table 1.

Table 1

Modes of irradiation of the samples by pulsed electron beam before (R5) and after treatment (R1-R4).

The morphology of the surface of the Si-HA coatings was investigated by scanning electron microscopy (SEM, ESEM Quanta 400 FEG) with integrated energy-dispersive X-ray spectrometer (EDS analysis system Genesis

Modes	$E_s, J/cm^2$	$\tau, \mu s$	f, Hz	N
R1	3	50	0,3	3
R2	0,8	50	5	50
R3	6,5	50	0,3	3
R4	8	50	0,3	3
R5	–			

4.000, S-UTW-Si (Li) detector). A glow discharge optical emission spectrometer (RF GD-OES) GD Profiler 2 was used for measuring of the elemental composition.

Fig .1 shows the surface morphology of the system "coating-substrate" before and after the IEB. Treatment of the calcium phosphate film and the titanium in this way results in changes to the topography of the formed surface. Prior to treatment, the surface of the coating is an alternation of evenly spaced ridges passing into the cavities. Modes of R1 and R2 are given a short term thermal annealing surface which causes formation of a homogeneous surface morphology. However, cracks are present. The scaly structure of the surface is preserved but the shape and size of the grains undergo changes. In the case where the energy density is 6.5 and 8 J/cm², the surface of the composite consists of a plurality of small, fused, shapeless and unevenly distributed particles (Fig. 1, d – e), with areas having low vividness.

In the case of modes R3 and R4 the elements of the substrate are the dominant elements. Thus, the ratio of Ca/P increased significantly for these regimes (Table 2), this indicates the preferential evaporation from the surface during processing of the phosphorus elements. However, at these energies of the beam coating could be mixed with material in the process of formation of new phases.

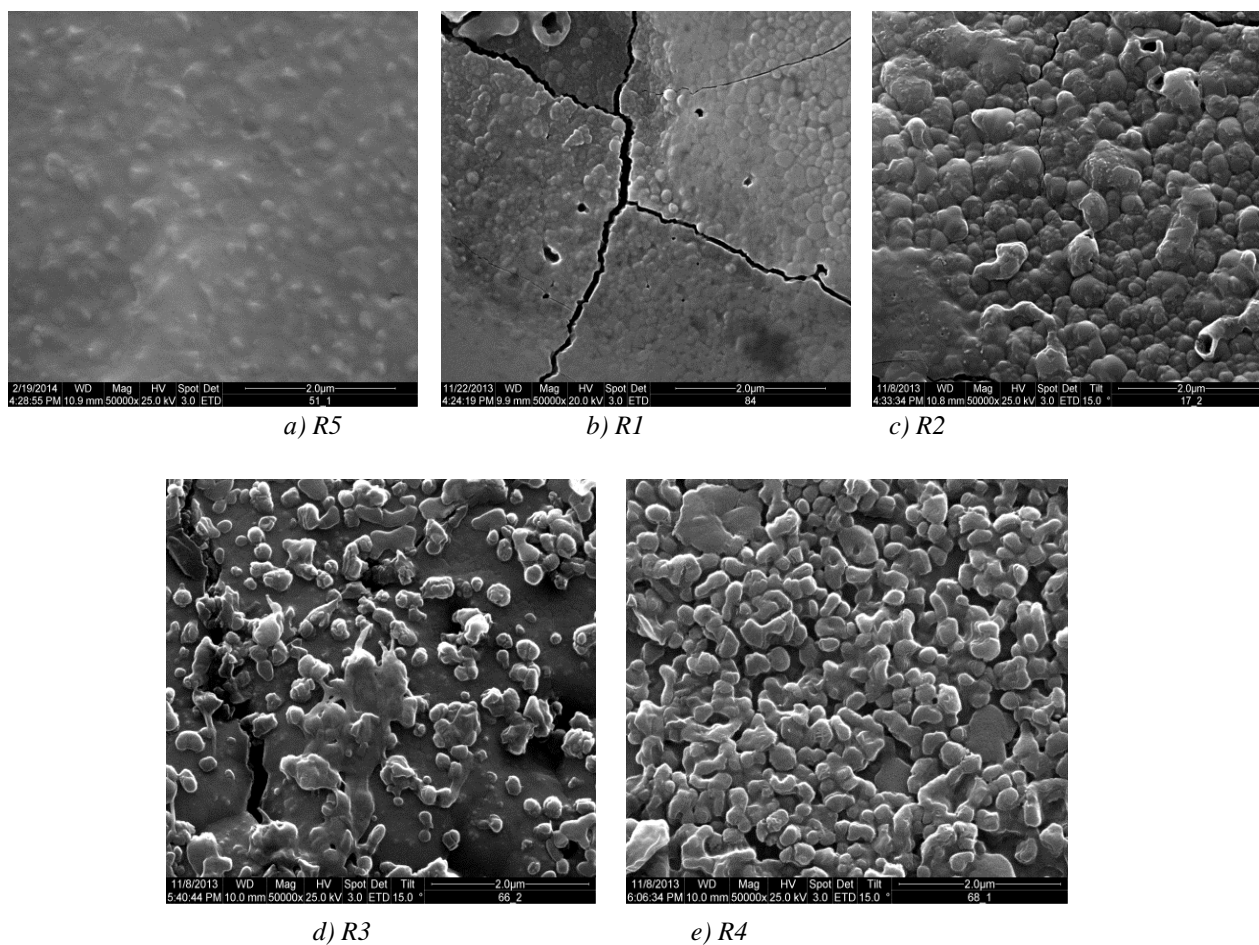

Fig.1. The morphology of the composite surface layer "coating-substrate" before (a) and after treatment with the pulsed electron beam (b - e).

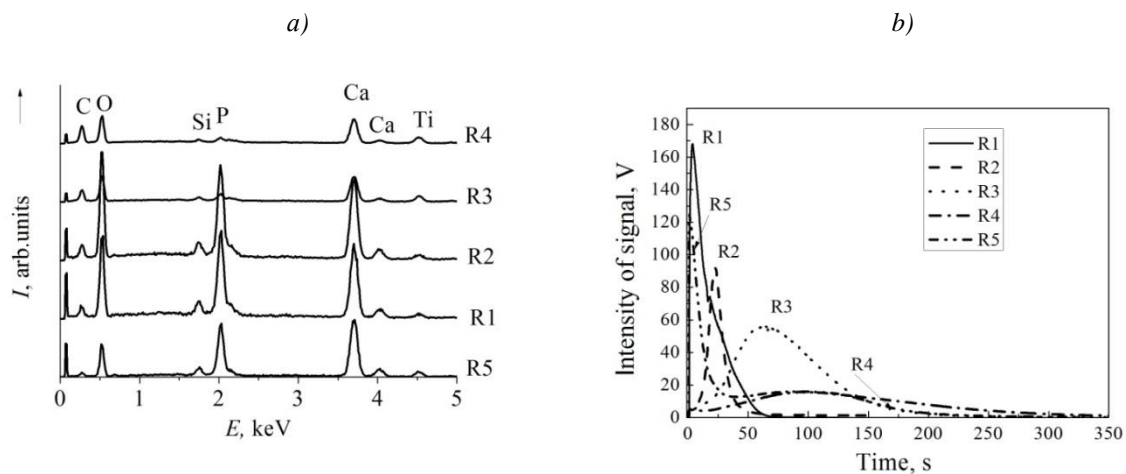

Fig. 2. EDS-spectra (a) and the calcium distribution in the depth (b) for the composite surface layer "coating-substrate" before (R5) and after treatment with the pulsed electron beam (R1-R4)

Table 2

Values of the ratios of Ca / P and Ca / (P + Si)

Regime	Ca/P	Ca/(P+Si)
R5 (before treatment)	1.94	1,66
R1	1.80	1.56
R2	1.87	1.66
R3	8.27	5.82
R4	11.96	8.29

Assumption about mixing is confirmed by the analysis of calcium content in the composite surface over depth, which is shown in Figure 2 b.

The abscissa indicates the time when the coating is sputtered at the moment of investigation, reflecting the composition of the sample changes depending on depth. Thus, treatment regimens by pulse electron beam having an energy density of 0.8 and 3 J/cm² lead to a thermal annealing of the coating formed on the titanium substrate. Using the beam with energy density of 8 and 6.5 J/cm² leads to partial vaporization and mixing of the coating material with titanium matrix. It is necessary to use x-ray diffraction to identify formed phases in the surface layer.

The authors thank Prof. N.N. Koval, Prof. M.Epple and Dr. O. Prymak for treatment and assistance in the studying of the samples. The studying was funded by grants of President of SP-6664.2013.4 and RFBR within the scientific project № 14-08-31027.

References:

1. Barinov S.M., Komlev V.S. Biokeramika na osnove fosfatov kaltsiya (Nauka, Moscow, 2005), p. 204.
2. Epple M. Biomaterialy i biomineralizatsiya. (Veter, Tomsk, 2007), p. 165.
3. Vavilova T. P. Biohimiya tkaney i zhidkostey polosti rta. (GEOTAR Media, Moscow, 2008), p. 208.
4. E. Saiz, M. Goldman, J. M. Gomez-Vega, A. P. Tomsia, G. W. Marshall, and S. J. Marshall, "In vitro behavior of silicate glass coatings on Ti6Al4V" // Biomaterials. –2002. – V. 23.– № 17, 3749–3756.
5. Surzhikov, A.P., Frangulyan, T.S., Gyingazov, S.A., Koval, N.N., Devyatkov, V.N.(2005). Izmenenie mikrotverdosti ferritovoy keramiki pri obluchenii silnotochnym impulsnyim puchkom nizkoenergeticheskikh elektronov. Izvestiya Tomskogo politehnicheskogo universiteta, V.308, №7, 23-27.
6. Pogrebnyak, A. D., Kulmenteva, O. P. (2003). Strukturno-fazovyye prevrascheniya v poverhnostnykh sloyah i svoystva metallicheskih materialov posle impulsnogo vozdeystviya puchkov chastits. FIP PSE, V.1, № 2, 108 – 136.
7. Pogrebnyak, A.D., Kravchenko, Yu.A., Kshnyakin, V.S.(2004). Termicheskiy otzhig s pomoschyu elektronnoy puchki i ego vliyanie na strukturu i fazovyyi sostav gibridnykh pokrytiy. VIsnik Sumskogo derzhavnogo unIversitetu. SerIya FIZika, matematika, mehanika, № 10(69), 182-196.
8. Surmeneva M.A., Chaikina M.V., Zaikovskiy V.I., Pichugin V.F., Prymak O., Buck V., Epple M., Surmenev R.A. (2013). The structure of an RF-magnetron sputter-deposited silicate-containing hydroxyapatite-based coating investigated by high-resolution techniques Surface and Coatings Technology. Biomaterials, V. 218, 39-46.

**DEVELOPMENT OF DYNAMIC, SPACE DISTRIBUTED MATHEMATICAL
MODEL OF DCT OF PRODUCTION URANIUM HEXAFLUORIDE
AND THE FURTHER MODELING OF PROCESS**

S.P. Golubey

Scientific Supervisor: Assistant N.S. Krinitsyn

Linguistic Advisor: Senior teacher N.V. Demyanenko

Tomsk Polytechnic University, Russia, Tomsk, Lenin str., 30, 634050

E-mail: *BoBBySS1992@gmail.com*

Annotation

The publication deals with two major hydrodynamic model, which is used in the simulation of mass transfer processes. This model of an ideal mixing and model of ideal displacement. Job pokkazyvaet their application in industry, namely the use of the device-combined type Work shows their application in industry, in part the use of the device-combined type.

1. Mathematical reactor model of ideal mixing

Mathematical description of the ideal mixing reactor (Figure 1.1) characterizes the change in concentration in the reaction medium in a time that is due to traffic flow (hydrodynamic factor) and chemical conversion (kinetic factor). Therefore, the model of ideal mixing reactor can be built on the basis of a standard model of ideal mixing considering the chemical reaction rate.

Ideal mixing model is idealized flow and provides the theoretical model. According to this model it is assumed that the flow entering the unit immediately distributed throughout the volume due to complete (ideal) mixing the particles of the medium. The concentration of the substance distributed at all points in the flow system and the output thereof is the same:

$$C_{in} \rightarrow C = C_{out}.$$

Differential equation model of ideal mixing will have the form:

$$\frac{dc}{dt} = \frac{v}{V} \cdot (C_{in} - C), \quad (1.1)$$

Where $\tau = \frac{V}{U}$ - the contact time, which characterizes the average residence time of the particles in

the reactor, s;

V - volume of the reactor, m³;

U - Volumetric flow material m³ / h.

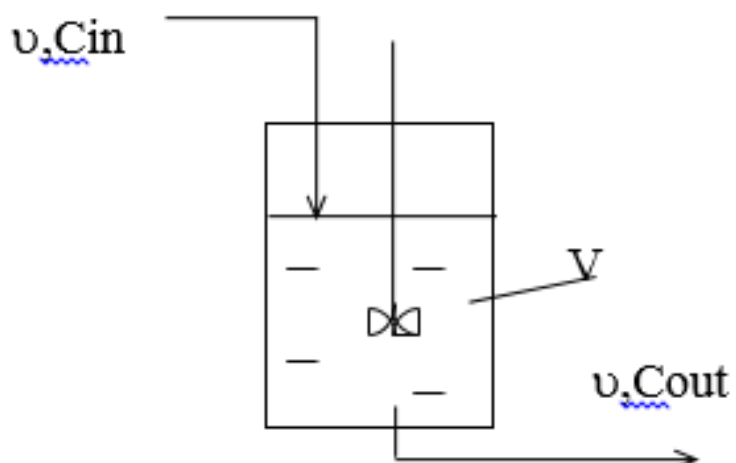

Fig. 1.1. Scheme of the reactor of ideal mixing

Equation (1.1) describes the change in concentration of a substance in an area ideal mixing due to flow.

Then, taking into account the kinetic factor, the dynamic model of an isothermal reactor with ideal mixing continuous action will have the form

$$\frac{dC_i}{dt} = \frac{1}{\tau} \cdot (C_{in} - C_{out}) \pm w_i \quad (1.2)$$

This equation is written for each of the components involved in the reaction. Then:

C_i - concentration of the i -th substance, kmol/m³;

w_i - the reaction rate of i -th substance kmol/m³.

The system of the above equations is a mathematical model of ideal mixing reactor taking into account changing concentrations over time (dynamic model).

For example, reaction $A \xrightarrow{k} B$ in equation (3.2) can be written:

$$C_{in} = C_{A0}; \quad C_{out} = C_A; \quad w_A = -k \cdot C_A;$$

$$\frac{dC_A}{dt} = \frac{1}{\tau_0} \cdot (C_{A0} - C_A) - w_A. \quad (1.3)$$

In the steady (stationary) operation of the reactor $\frac{dC_i}{dt} = 0$, then the equation (3.3) can be written as :

$$\begin{aligned} \frac{1}{\tau} \cdot (C_{A0} - C_A) &= w_A, \\ \tau &= \frac{C_{A0} - C_A}{w_A}, \end{aligned} \quad (1.4)$$

$$x_A = \frac{C_{A0} - C_A}{C_{A0}}.$$

Using expressions (1.3), (1.4), we can find the main parameters characterizing the operation of the apparatus:

- 1) τ - residence time in the reactor of the starting material, the magnitude of which depends on the volume of the apparatus (the lower τ , the smaller V);
- 2) changing the concentration of the reactants, as a function $f(\tau)$, and hence to calculate the degree of conversion and selectivity.

Similarly, the material balance equation of ideal mixing reactor (3.2) The equation of heat balance. Thus, we obtain for the adiabatic reactor

$$C_p^{mix} \frac{dT}{dt} = \frac{C_p^{mix}}{\tau} \cdot (T_{in} - T) + \sum_{j=1}^N (-\Delta H_j) \cdot W_j, \quad (1.5)$$

where :

W_j - the speed of the j-th chemical reaction, 1 / s;

ΔH_j - The thermal effect of the j-th of the chemical reaction, Joule / mol;

C_p^{mix} - Heat capacity of the reaction mixture, J / mol K \square ;

T_{in} - Temperature at the reactor inlet, K;

T - The current temperature, K.

Heat capacity i - substance as a function of temperature is described by the following equation:

$$C_{P_i} = (a_i + b_i \cdot T + c_i \cdot T^2 + d_i \cdot T^3) \cdot 4.1887. \quad (1.6)$$

Heat of the mixture is calculated by the additivity rule:

$$C_P^{CM} = \sum_{i=1}^N C_{P_i} \cdot C_i, \quad (1.7)$$

where C_i - the concentration of i-th substance mixture mole share.

The dependence of the rate constant on a chemical reaction temperature is expressed by the Arrhenius equation

$$k_i = k_{i,0} \cdot e^{-E_i/R \cdot T}, \quad (1.8)$$

Where:

k_i - the rate constant i-th chemical reactions (for a first order reaction, 1/s);

$k_{i,0}$ - pre-exponential factor , s-1 ;

E_i - activation energy of the i-th reaction, Joule / mole ;

R- universal gas constant , R = 8,314 J / mole * K.

In order to investigate the dynamic behavior of the reactor ideal mixing , i.e. tracking changes in concentrations of reactants and temperature over time at the exit of the reactor , it is necessary to solve the system of differential equations for each material balance of the components and the heat balance equation .

2. Mathematical reactor model of ideal displacement

Mathematical models of chemical reactors are based on the principle of using a block model of hydrodynamic models that take into account the motion of matter flows.

In accordance with a model of ideal displacement piston taken along flow without stirring for a uniform flow distribution of the concentration of a substance in a direction perpendicular to the movement (Fig. 3-2).

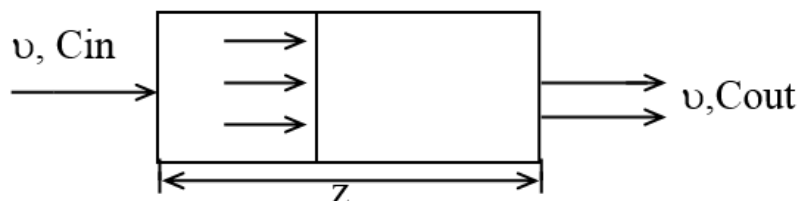

Fig. 3.2. Scheme of ideal displacement

Differential equation model of ideal displacement has the following form:

$$\frac{\partial C_i}{\partial t} = -u \cdot \frac{\partial C_i}{\partial l}, \quad (1.9)$$

Where:

C - concentration substance mole/l;

t- time , seconds;

u- linear flow velocity, m / s;

l- coordinate (length unit) , m

Mathematical model of ideal displacement is a differential equation in partial derivatives, since the concentration varies in time and space. Such a model is called *a model with distributed parameters*.

Model of ideal displacement corresponds to a first approximation process in tubular devices for which the ratio of length to diameter of the pipe is more than 20 or diffusion Peclet number is set to ≈ 100 .

If we substitute the linear flow velocity u for the value $u = v/S$, in the equation (1.9), we obtain :

$$S \frac{dC_i}{dt} = -v \frac{dC_i}{dl}, \quad (1.10)$$

Where:

S - the cross section area of ideal displacement, m²;

v - Volumetric flow rate (flow) of the substance, m³ / s.

If the mathematical model of ideal displacement is considered as changing the concentration of power at the expense of chemical reaction, the material balance of a plug flow reactor can be written as

$$\frac{\partial C_i}{\partial t} = -u \frac{\partial C_i}{\partial l} \pm W_i, \quad (1.11)$$

Where:

C_i - the concentration of the corresponding i-th material;

W_i - Reaction rate of i-th substance.

Heat balance equation adiabatic flow reactor

$$\rho^{mix} \cdot C_p^{mix} \cdot \frac{\partial T}{\partial t} = -U \cdot \rho^{mix} \cdot C_p^{mix} \cdot \frac{\partial T}{\partial l} + \sum_{j=1}^N \left(\pm \Delta H_j \right) \cdot W_j \quad (1.12)$$

Hence, the mathematical description of a plug flow reactor is characterized by changing the concentration and temperature of the reaction medium in time and space due to movement of the flow (hydrodynamic factor) and chemical conversion (kinetic factor).

Equation (3.11) is written for each of the components involved in the reaction. For example, for the reaction in an isothermal plug flow reactor, mathematical model (dynamic mode) will have the form

$$\begin{aligned} \frac{\partial C_A}{\partial t} &= -u \cdot \frac{\partial C_A}{\partial l} - k \cdot C_A, \\ \frac{\partial C_B}{\partial t} &= -u \cdot \frac{\partial C_B}{\partial l} + k \cdot C_A. \end{aligned} \quad (1.13)$$

In the steady (stationary) operation of the reactor

$$\frac{\partial C_A}{\partial t} = 0; \quad \frac{\partial C_B}{\partial t} = 0, \quad (1.14)$$

When

$$u \frac{dC_A}{dl} = -k \cdot C_A, \quad (1.15)$$

$$u \frac{dC_B}{dl} = k \cdot C_A.$$

since the $\frac{l}{u} = \tau$, equations (1.15) take the form

$$\frac{dC_A}{d\tau} = -k \cdot C_A, \quad (1.16)$$

$$\frac{dC_B}{d\tau} = k \cdot C_A,$$

Where τ - the residence time of reactants in the reactor core (contact time), sec.

In order to investigate the variation of the concentrations of reactants and temperature of the chemical reactor, it is necessary to solve the system of differential equations of (1.11, 1.12).

At this moment my work on modeling of processes occurring in the DCT, represents basic equations describing the behavior of the system under different assumptions, which are accounted for in the modeling of the system by various methods, namely a model of ideal mixing and plug flow model. Further work will go towards the unification of the models described above into one. It will be able to show the work of the unit in an

environment closest to the real, and can use it in the future to the real production process.

References:

1. Chursin Y.A., Gorunov A.G., S.N. Liventsov The system automatically and control the extraction column // News Tomsk Polytechnic University. - 2007.
2. Balashov A.A., Lossievsky V.L., V.N. Chernyshev, Schwab A.F., Shelemin B.V. Diagrams and automation radiochemical productions. - Gosatomizdat, 1963.
3. Baydali S.A., Krinitsyn N.S., Dyadik V.F. Parametric synthesis of a two-cascade system automatically Control // Proceedings of Higher Education institutions. Physics. - 2010.
4. Liptser R., Robert S. Statistics of Random Processes. General Theory/ Ed. by R.S. Liptser, A.N. Shiryaev. – Berlin: Springer Verlag, 2001.

SELF-PROPAGATING HIGH-TEMPERATURE SYNTHESIS

S.S Guralev, A.A. Grishin

Scientific Supervisor: Senior teacher M.S. Kuznetsov

Linguistic Advisor: Teacher Y.V. Ermakova

Tomsk Polytechnic University, Russia, Tomsk, Lenin str., 30, 634050

1.Introduction

Self-propagating high-temperature synthesis (SHS) - the process of moving wave chemical reaction by the reagent mixture to form a solid end product, conducted with the aim of synthesis of compounds of materials. CBC mode is a strong flow of exothermic reaction (combustion reaction) in which localized heat generation in the bed and is passed from layer to layer by heat. (Shown in Figure 1)

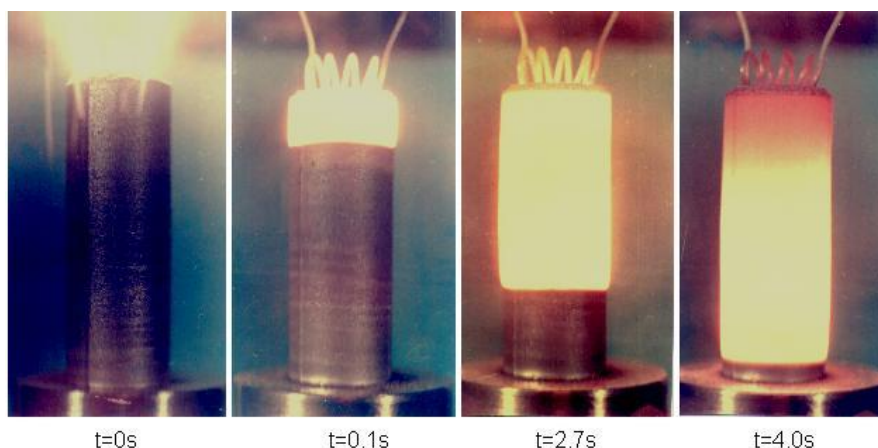

Fig.1

The aim of the work was to study ways to control the SHS process for the example of a lanthanum-boron.

2.Source Systems

2.1.Morphology of reagents and types of source systems

Reagents used in the SHS process to form fine powders, thin films, liquids and gases. The most common type of two systems: the mixture of powders (or a compacted bulk density), and hybrid systems dioxide powder (or pressed agglomerate). SVS-known processes and systems: powder-liquid gazovzves, film-film, gas-gas.

The main requirements for the initial system - providing conditions for effective interaction of the reactants.

Batch processes in SHS can be in vacuo, outdoors, or reacting, in an inert gas under pressure.

2.2.Chemical classes of components of the original systems

In creating the SAF system may involve all the reactive substances at high temperatures, the reactants (chemicals, individual compounds multiphase structure) and inert substances as fillers or diluents.

Most Popular reagents:

H₂, B, Al, C, N₂, O₂, Mg, Ti, Nb, Mo, Si, Ni, Fe, B₂O₃, TiO₂, Cr₂O₃, MoO₃, Fe₂O₃, NiO, etc.

As reagents used as industrial minerals and waste.

Terms matching components SHS system:

- exothermic interaction of reactants
- Cumulative formation of solids

- technical and economic feasibility.

3.Processes

3.1.Combustion in SHS processes, it was called "solid flame" (or "solid-" burning)

The three most common types of combustion:

- gasless (Mixed combustion in engines without outgassing or release of small amounts of impurity gas)
- filtration (burning-in hybrid systems with the filter inlet reactant gas to the combustion front)
- multiphase (combustion in multiphase media - the source or generated)

3.2.Initiation methods

The main way - local initiation of the reaction on the surface of the system by supplying short heat pulse (electric coil, spark discharge, laser beam, etc.) to form a combustion wave and its distribution is not heated to the starting material. The duration is typically much less than the initiation time of the combustion charge.

In some cases (eg, for weakly exothermic reactions), the process is initiated by heating the entire surface of the charge in the furnace and carried it out in a thermal explosion(Fig. 2)

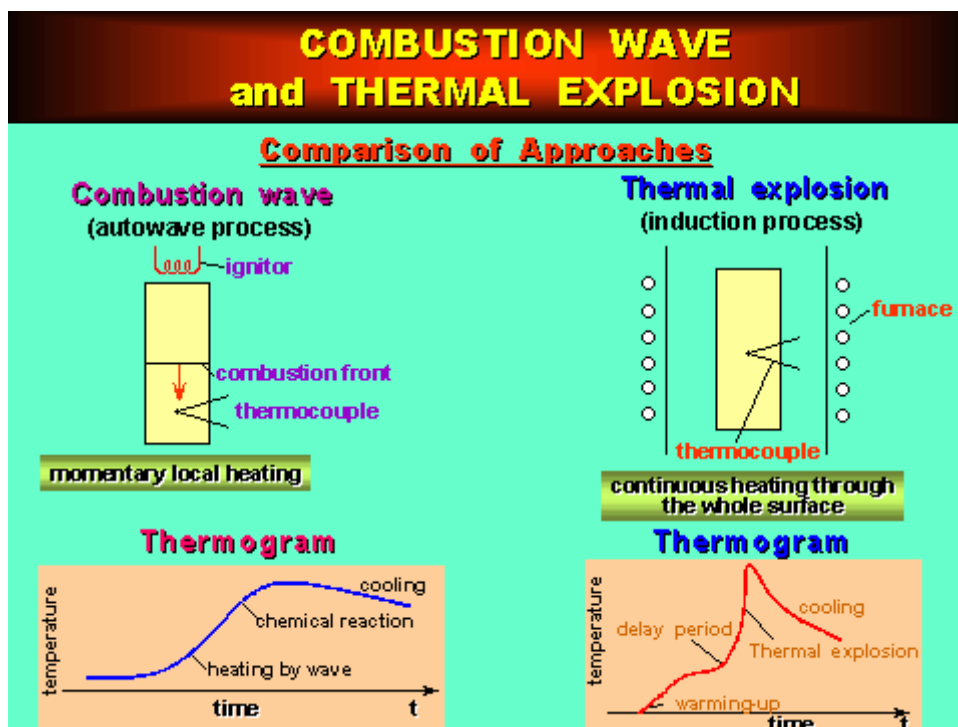

Fig.2

3.3.Regimes of propagation of the combustion front

In the simplest and most important steady state (Fig. 3) all points of the front move at a constant in time and the same speed. When stationary regime loses its stability, can be unstable regimes of front propagation:

- flat rate oscillations of the combustion front (pulsating combustion (Fig. 4)),
- localization of the combustion reaction in the centers moving along a helical path (spin waves (Fig. 5)),
- random motion set combustion sources (solid chaotic flames).

Combustion wave is not covered by the charge in the case of strong heat loss to the environment (small

diameters of charge samples, low adiabatic reaction temperature of reagents).

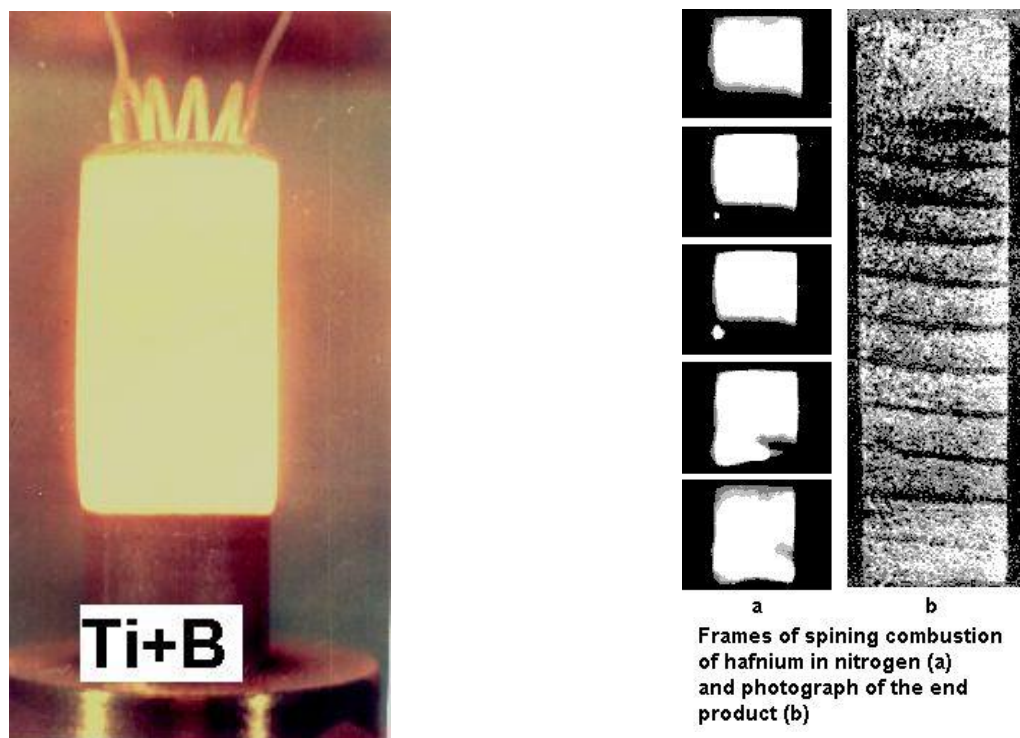

Fig. 3 gure 5

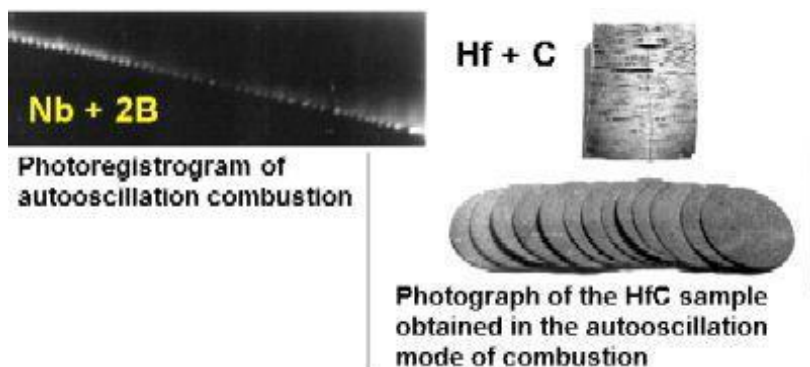

Fig. 4

3.4. Thermogram burning

Thermogram burning - this temperature dependence of the charge at a fixed point of time for clash of the combustion wave. simplest thermogram (Fig. 6) consists of the ascending portion, with the point of maximum temperature (combustion temperature) and downstream area (cooling). On more complex thermograms are kinks, kinks, plateaus (isothermal surface). In unstable combustion regimes in the thermograms recorded temperature fluctuations on the ascending phase.

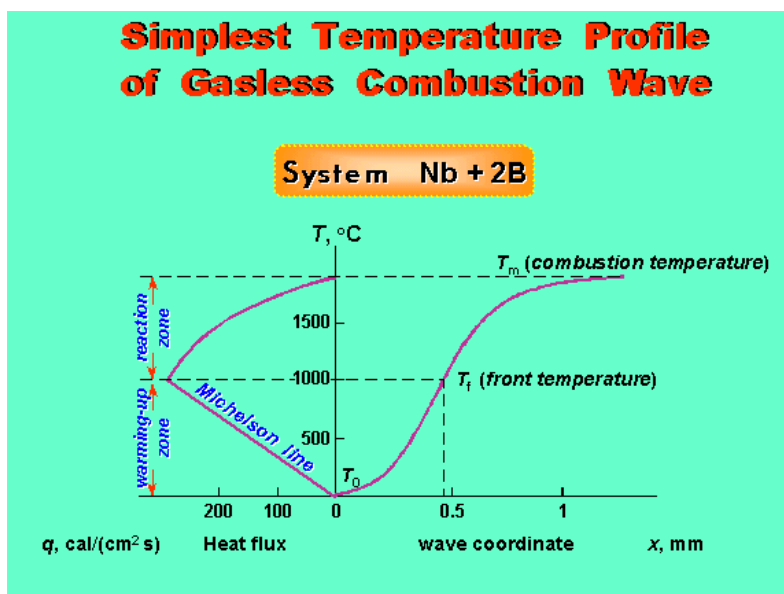

Fig. 6

3.5. Front wave and post-processes

In the combustion wave occur various chemical, physical and physico-chemical processes in their totality provide the necessary heat. The wave has a certain length and consists of a series of zones:

- heating zone or preflame zone (combustion reaction it still did not leak, but only provided heat transfer and heating charge)
- reaction zone (in which the main flow of the combustion reaction, providing the necessary heat dissipation)
- afterburning zone (in which chemical reactions going on, but they do not affect the speed of propagation of the front)
- zones (stages) of the secondary physical and chemical transformations that define the structure and composition of the final products.

Spread zone of chemical reactions called the combustion wave. Front - a conditional surface separating the heating zone and the reaction (the cutting edge of high-temperature zone of the wave). Passage of the combustion wave is the main stage of SHS. Popular formula:

$$\text{SHS} = + \text{burning structure formation,}$$

secondary physicochemical transformations constitute the second stage of SHS.

3.6. Key characteristics

The process of wave propagation is characterized by:

- extinction limit (between the parameters of the system, separating the two situations: the wave propagation and the lack of combustion under all conditions of initiation)
- buckling limit (between the parameters of the system, sharing regimes and unstable stationary combustion)

- propagation velocity of the front,
- the maximum temperature and
- heating rate in the wave stationary combustion,
- in unstable processes - frequency ripple speed hearth helical path, the value of the superadiabatic effect, etc.
- depth chemical transformation of initial reagents in the final products (combustion completeness)
- nonequilibrium combustion product characterizing incomplete phase and structural transformations in the process, the cooling rate of the combustion products (rare).

Most often realizable values of certain characteristics of SHS process:

The burning rate	0.1-20 cm / s
Combustion temperature	2300-3800 K
Heating rate in the wave	$10^3 - 10^6$ deg / s
Power Plug	10-200 cal / (cm ²)
Ignition delay	0.2-1.2 with
Ignition temperature	800-1200 K

Due to the high values of the velocity and temperature of combustion and heating rate in the wave of SHS is classified as extreme chemical processes.

3.7. Chemical classes of reactions SHS

SHS processes for the chemical nature of the reagents directly irrelevant - only important value of the heat effect of the reaction and the laws of heat and heat transfer, the aggregate state of the reactants and products, the kinetics of phase and structural transformations and other macroscopic characteristics of the process.

Therefore chemistry SHS processes varied. The most widely used

- the synthesis reaction of the elements

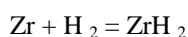
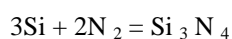
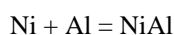
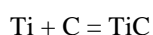

- redox reactions

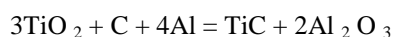

- oxidation of metals in complex oxide environments

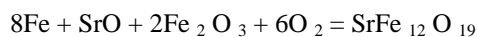
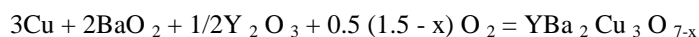

Also known SHS reaction

- Synthesis of compounds

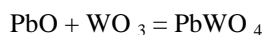

- interaction decomposing compounds with elements

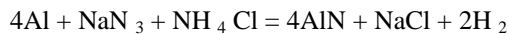
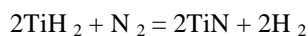

- thermal decomposition of the complex compounds

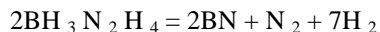

4. Products

And characterized by a variety of micro-and macrostructures.

4.1. Morphology and macrostructure

SHS Products solids represent an arbitrary shape in different sizes. This different dispersion of the powders weakly associated aggregates of particles, foams, specs and ingots with different strength, films, fibers, crystals. Mass of products depends on the initial values and, to some extent, from the mechanism of the process.

In mixed systems macrostructure usually homogeneous in hybrid (gas-porous body) in the presence of filtration difficulties may occur composition distribution over the cross section of the sample after SHS.

In special cases, deliberately creating heterogeneous macrostructure combustion product (obtaining multilayer and functionally graded materials).

4.2. Composition

Chemical and phase composition of the products is determined by the composition of the source systems, their state diagrams, combustion efficiency, cooling conditions (cooling).

Impurity composition of the products is determined not only the purity of the reactants, but depends on the depth of the combustion process with self-cleaning. Products obtained under optimal conditions, characterized by high purity of unreacted starting material and the impurity oxygen.

4.3. Microstructure

SHS products are usually polycrystalline structure with a crystallite size of 1-5 microns. Known examples of the preparation of nanosized (and amorphous), as well as coarse structures (with crystal sizes of up to 3 mm).

Crystallite sizes depend on the rate of cooling of the sample after combustion and kinetics of crystallization and recrystallization processes.

The porosity of the solid (non-dispersible) combustion products can vary from nearly zero (compact material) to high (90-95%, foams).

5. Management techniques

Objectives:

- Control the speed, temperature and completeness SHS process
- Composition of the structure and accordingly the properties of SHS-products.

Purpose:

- Optimization of SHS to meet the requirements in certain cases.

Management techniques:

- Impact on the characteristics of SHS (see paragraphs. 2 and 3) of the basic parameters of the initial charge (batch composition, the particle size of the reactants, the density, the size and initial temperature of the charge, the nature and concentration regulating additives and excipients), as well as the combustion conditions (composition and ambient pressure, the effect of electrical, electromagnetic and gravitational fields, mechanical stress) using the preliminary studies and the known general laws.

5. Conduct work

Initially were trained powder s, which were selected L A2O3 and TiO 2, and then they were mixed in various proportions with B and sent to the mill (results in table 1)

Table 1. Dependence of particle size (nm) of the speed (Hz)

	La2o3	TiO2
0	33.6	79
10	22.8	71.7
20	17.5	72.7
30	20.4	66.4
40	20	64.3

According to the results that blitz a schedule (Fig. 1), n is not that the particle size is not linearly dependent on the speed of the mill, as well was monitored initiation temperature dependence of the speed given in Table 2 and a schedule (Fig. 2)

Table 2. initiation temperature dependence on the rotational speed

	5 minutes		10 minutes		15 minutes		20 minutes		25 minutes	
	Institute	max	Institute	max	Institute	max	Institute	max	Institute	max
0	540	707	558	708	548	712	551	685	557	779
10	540	732	561	738	550	766	533	723	529	777
20	478	712	456	787	462	723	463	720	495	749
30	490	729	480	751	475	720	467	771	552	782
40	517	765	526	714	508	727	576	785	555	802

Dependence sizes of particals La2O3 from rotation frequency

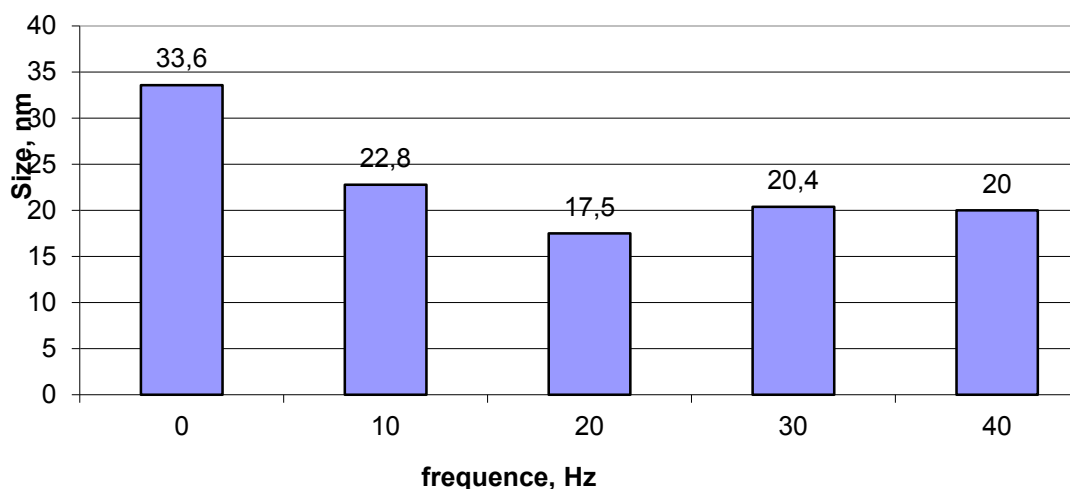

Fig.1 Dependence of particle size on the speed

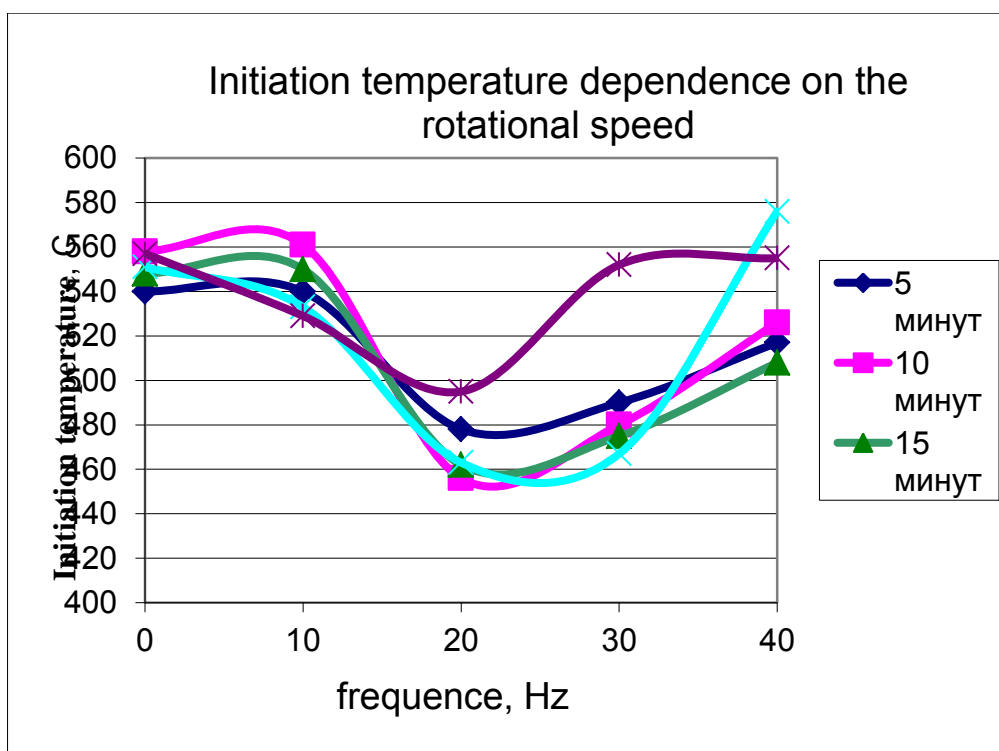

Fig. 2 . initiation temperature dependence on the rotational speed

From the graph, we can see that the minimum temperature attained in rotational frequency of 20 hertz, it may be explained by the data of Table 1, namely that for a given speed is reached the minimum size of particles, which in turn:

- leads to disruption of the integrity of the materials and increase the free surface of the substances;

- causing elastic deformation of the plastic. The relaxation of residual stresses and deformations in solids at low temperature occurs slowly enough, and therefore, the substance by the action of mechanical forces divergnutoe some time margin has "excess" energy;
 - distortion of the crystal lattice of the mineral that is the cause of point d efekt and linear dislocations;
 - violation of the integrity of the crushed material leads to the rupture of chemical bonds of matter;
- T ak during a research work was conducted burning mixtures obtained (in the form of compressed tablets) prepared by SHS and refine the composition shown in Table 3.

Table 3. Results combustion substances

Composition	without NiAl	time, min	serial numbers	La2O3	LaBO3	LaB6	TiO2	TiB2	B2O3	B	
10Hz		5	1	16.7	18.6	1.3	30	0.5	2	30.9	100
		10	2	14.2	35.5	0.7	19.6	2	3	25	100
		15	3	3	64.9	3	5.1	10	4	10	100
		20	4	5	57.6	2.4	15	12	2	6	100
		25	5	8	63	1.1	10.3	7	2	7	98.4
10Hz											
	c NiAl			La2O3	LaBO3	LaB6	TiO2	TiB2	B2O3	B	
		5	1		15.1	3.3	15.8	6.3	6.5	53	100
		10	2		14.2	63.1	3.2	11.5		8	100
		15	3	5.6	1.7	65	3.7	15.7	6.3	2	100
		20	4	7.1	2.7	58	3.4	13.3	12.5	3	100
		25	5		31.7	43	3.3	13		9	100

After the first series of combustion was found that the residue of unburnt boron is relatively high, it was decided to add NiAl. Reaction did not pass without the addition of nickel delayed at an intermediate stage (Education LaBO 3)

The table also shows that after addition of NiAl In the residue decreased significantly and in the 15th minute we get optimum reduction of unnecessary impurities up to 2 percent due to activation and Ni.

Conclusions: During the work done were identified ways to control SHS processes by changing the SAF system, were also discussed in more detail the parameters themselves, and implemented a series of test batches of different compositions and variations of the basic mixture that after it was implemented in the tables and graphs

Recommendation: Continue to study and experiment to find the optimal share e NiAl added to optimize the SHS process to obtain the highest possible purity of unreacted starting in eschestvam and oxygen impurity in the self-cleaning process.

REFERENCES

1. Fizika izmel'chenija, Hodakov G. S., 2005 g., Har'kov.
2. Mehanohimija i mehanicheskaja aktivacija tverdyh veshhestv, Boldyrev V. V., 2006 g., Novosibirsk.

3. "Self-propagated high-temperature synthesis of refractory inorganic compounds", A.G. Merzhanov, I.P. Borovinskaya. Doklady Akademii Nauk SSSR, Vol. 204, N 2, pp. 366-369, May, 1972
4. Directed self-propagating high-temperature synthesis of explosion-emissive cermet materials / V. I. Boyko [et al.] // physics of burning and explosion / Russian Academy of Sciences (RAS)

THE ACTIVATED CHARCOAL ADSORPTION OF PHENOL

M.E. Kondrashin, K.A. Solovyova, E.A. Tsareva

Scientific Supervisor: PhD Associate professor E.V. Miheeva

Linguistic Advisor: Senior teacher U.A. Smirnova

Tomsk Polytechnic University, Russia, Tomsk, Lenin str., 30, 634050

E-mail: makcucha@yandex.ru

Abstract

Key words: activated charcoal, phenol, adsorption, water treatment, Langmuir's and Freundlich's adsorption isotherm, physical adsorption, chemical adsorption, area, chemical reaction, experience.

Research field: Colloidal Chemistry.

Related sciences: Physics, Ecology, Mathematics .

The problems of treatment of the waste water were considered in this work. The main method of the activated charcoal adsorption of phenol was investigated. The adsorption properties of the adsorbent were also considered. Along with it Langmuir's and Freundlich's adsorption isotherm has been studied and analyzed.

Introduction

Objectives: researching of waste water was considered in this work. The main method of the activated charcoal adsorption of phenol from aqueous medium; the removal of phenol method of the activated charcoal adsorption of phenol from wastewater.

There are a lot of industrial companies which have problems of discharge into aqueous medium chlorophenol and phenol on the territory of the Russian Federation. These substances possess cancerogenic properties which promote destruction of biocenoses and deterioration of natural waters. Sewage water of industrial companies needs cleaning. There are methods of water treatment from phenol and chlorophenol: extraction, evaporation, sorption. Using of activated charcoal can be effective for purification of low-concentration sewage water. Phenols are widespread kind of industrial sewage water pollution. It is found in sewage water manufactures related to thermal processing of timber, shale, peat, plastics factories. For economic reasons, if concentration exceeds 2 g / l regeneration of phenols from sewage water is suitable. However, regeneration methods are sometimes used for lower concentrations.

The phenomenon of adsorption on the activated charcoal

We will consider the adsorption phenomenon on the activated charcoal and properties of this adsorbent. The activated charcoal is adsorbent with highly developed porosity which is received from various carboniferous materials: charcoal, coal coke, oil coke, coco shell, etc. The activated charcoal, made of a coco shell, is the best quality cleaning and service life. It can be regenerated repeatedly thanks to high durability. The activated charcoal possesses high adsorption because it has a large number of pores. Increase of porosity is called activation. This process consists in opening of closed pores by means of processing with superheated steam or carbon dioxide.

Classification of pores in the activated charcoal

Macro-, meso - and micro – pores are distinguish in activated charcoals. Activated charcoal should be processed with different ratio of pore size , since the adsorbates molecules have different sizes . Pores in activated

charcoal are classified according to their linear dimensions – X (half-width - for the slit pore model , the radius - for the cylindrical or spherical model)

$X \leq 0,6-0,7$ nm - micropores ;

$0.6-0.7 < x < 1.5-1.6$ nm - super- micropores ;

$1.5-1.6 < x < 100-200$ nm - mesopores ;

$X > 100-200$ nm - macropores .

The mechanism of volume filling is characteristic for adsorption in micropore. In supermicropores -intermediate area between micropores and mesopores the adsorption takes place in a similar way. In this area, properties of micropores gradually degenerate and properties of mesopore appear . The mechanism of adsorption in mesopores is sequential formation of adsorption layers (polymolecular adsorption) , which then is completed by pore the filling according to capillary condensation mechanism. Macropores serve as transport channels bringing absorbed molecules to adsorption space activated charcoal granules . Micro-and mesopores comprise the greatest part of the surface of activated charcoal , respectively , they contribute mostly to their adsorption properties . Micropores suit particularly well for adsorption of small sized molecules, but for mesopores adsorption large of organic molecules. Feedstock of activated charcoal structure has determining influence. Activated charcoals based on coco shell are characterized by a higher proportion of micropores , and activated charcoal produced by from coal - a larger share of mesopores. A large proportion of macropores is characteristic of activated charcoals based on timber. [3]

Intermolecular attraction which leads to the adsorption force exists in activated charcoal pores. The removed pollutant molecules are retained by intermolecular forces of Van der Waals on the surface of activated coal. Thus, activated charcoals remove contaminants from the being clean . Chemical reactions can also occur between the adsorbed substances and activated charcoal surface. These processes referred to as chemical adsorption or chemisorption . However, basically physical adsorption process occurs when an activated charcoal and the adsorbed substance react . Physical adsorption is reversible, i.e. adsorbed substances can be separated from the surface and returned to their original state under certain conditions. In chemisorption , associated adsorbate is linked with surface by means of chemical bonds. Chemisorption is not reversible. [4]

With this understanding of how the adsorption process works, we must then understand why it works, or why water contaminants become adsorbates. Water contaminants adsorb because the attraction of the carbon surface for them is stronger than the attractive forces that keep them dissolved in solution. Those compounds that are more adsorbable onto activated carbon generally have a lower water solubility, are organic (made up of carbon atoms), have a higher molecular weight and a neutral or non-polar chemical nature. It should be pointed out that for water adsorbates to become physically adsorbed onto activated carbon, they must be both dissolved in water and smaller than the size of the carbon pore openings so that they can pass into the carbon pores and accumulate.[5]

Experiment

We investigated efficiency of water purification from phenols by adsorption on activated charcoal. For the experiments we took phenol without rectification. The maximum solubility of phenol in water at the room

temperature is 6,7 g on 100 ml. The concentration of phenol is 4 mol / l, 8 mol / l, 16 mol / l, 24 mol / l . We poured 1 g of activated charcoal previously pounded in a porcelain crucible and flowed the received solutions in the test tubes. We closed the test tubes jams, placed into a shaker and carried out adsorption process during 30 minutes supposing the adsorption equilibrium is established during this time. The concentration of phenol solution will decrease due to the adsorption of its molecules on the particles of coal. When phenol was adsorbed on activated charcoal at 20 ° C the following data were obtained:

Tab 1. The concentrations and phenol adsorption

Γ , mmol/g	1,2	1,4	1,8	2,1
C, mmol/l	4	8	16	24

For more detailed studying we will determine adsorption by Langmuir and Friendlich's equation. We will analyze these equations and conclude which of them more accurately expresses the adsorption of phenol on activated charcoal. For finding of size of limit adsorption Γ_{∞} we will construct an adsorption isotherm in coordinates of a linear form of the equation of Langmuir $C/\Gamma = f(C)$.

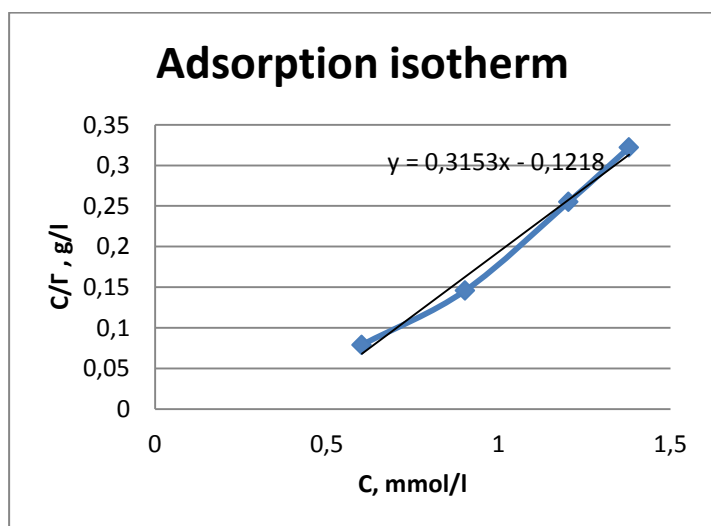

Graph 1. Adsorption isotherm.

We calculated constants Γ_{∞} and K in Langmuir's equation on a graph: $\Gamma_{\infty} = 2,5$; K = 0,2.

For finding of constants in Friendlich's equation of B and $1/n$ we will construct a straight line in coordinates Γ and C.

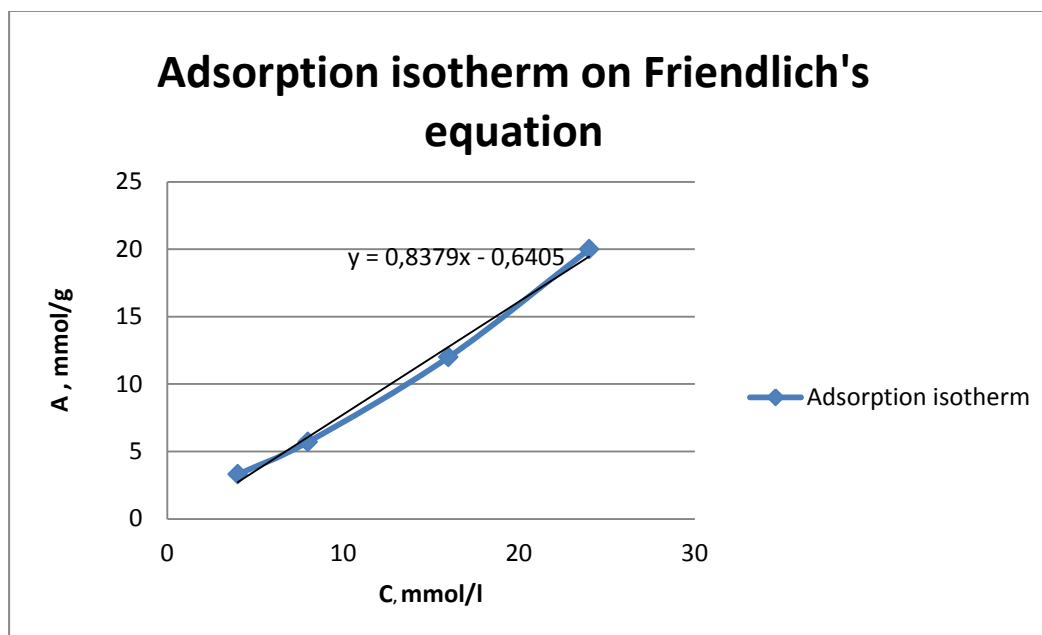

Graph 2. Adsorption isotherm on Freundlich's equation

We calculated constants in Freundlich's equation: $B = 0,13$; $1/n = 0,038$.

We will construct dependence of specific adsorption on equilibrium concentration of phenol. We carry out construction by means of Freundlich's equation and experimental data. We will find value of specific adsorption Γ_{ϕ} on Freundlich's equation:

$$\Gamma_{\phi} = K \cdot C^{\frac{1}{n}}$$

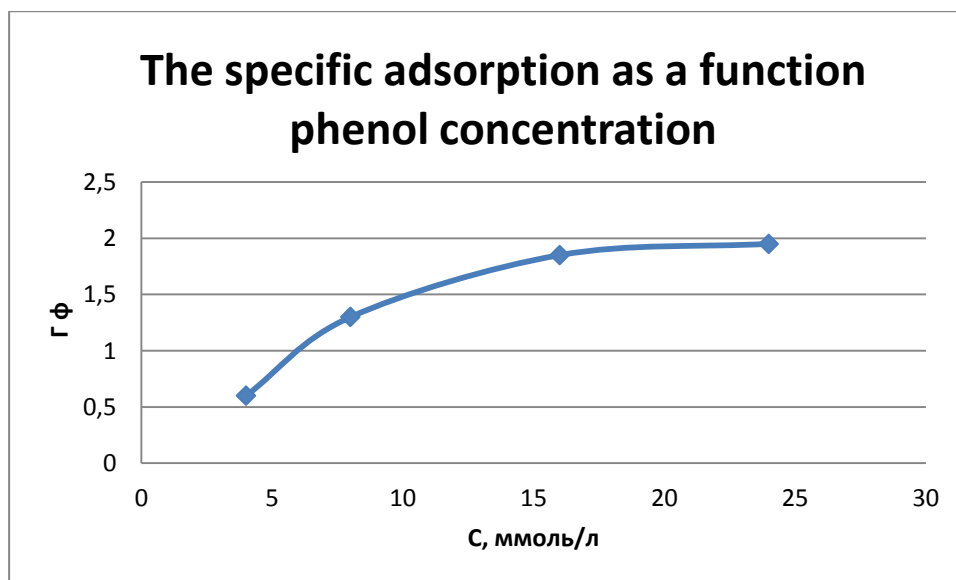

Graph 3. The specific adsorption as a function phenol concentration

Freundlich's equation reflects process of adsorption of phenol as the isotherm of adsorption is more approximate to an isotherm constructed on experimental data.[6]

Conclusion

Water treatment from phenols is not only economically efficient, but also prevents deterioration of an ecological situation. There is an economy of means because we can return the phenol adsorbed on coal again in production. In the work we used isotherms of adsorption of Langmuir and Freundlich thanks to which it is possible to track sorption properties of a material which are necessary for definition of a technological mode of the adsorptive installation. Efficiency of removal of pollution depends on the nature polluting substance, type of coal, the initial levels of pollution and gas parameters. A thorough understanding of these sorptive mechanisms is essential for accomplishing the most effective use of active carbon in water and waste water treatment. Carbon adsorption on activated charcoal is a highly effective method and possesses high level of removal.

References

1. Dolina L.F. Stochnie voidi predpriyatii gornoj promishlennosti i metodi ih ochistki. Dnepropetrovsk, 2000.
2. Frog B.N., Levchenko A.P. "Vodopodgotovka" M.:MGU, 1996
3. Smirnov A.D."Sorbcionnaya ochistka vodi".L., Himiya, 1982
4. Fridrihsberg D.A. Kurs kolloidnoi himii: Sankt- Peterburg "Himiya" 1995, pod redakciei doktora him. Nauk prof. M.P. Sidorovoi.
5. TIGG corporation, The Story of Activated Carbon By Robert T. Deithorn and Anthony F. Mazzoni <http://www.tigg.com/what-is-activated-carbon.html>
6. Frolov Yu.G. Kurs kolloidnoi himii, Poverhnostnie yavleniya I dispersnie sistemi . M.: Al'yans, 2009.

CALCULATING METHODS OF THE POLARIZATION RADIATION CHARACTERISTICS

E.V. Kornoukhova

Scientific Supervisor: Engineer D.A. Shkitov

Linguistic Advisor: Senior teacher N.V. Dem'yanenko

Tomsk Polytechnic University, Russia, Tomsk, Lenin str., 30, 634050

E-mail: winterhof@sibmail.com

POLARISATION RADIATION, DIFFRACTION RADIATION, TRANSITION RADIATION, VIRTUAL PHOTONS METHOD, IMAGES METHOD, POLARISATION CURRENT METHOD, RADIATION CHARACTERISTICS.

Nowadays, research in the high energy physics is an important component of modern science. Advanced technologies and new knowledge can provide answers to fundamental questions about the properties of matter. But with the advent of new technologies and knowledge there is a need for new theoretical and data analysis tools. Therefore it is necessary to develop and explore different methods of processing experimental data. As well as the development of various methods calculating the characteristics of the studied systems. That is why the aim of this work is to study existing methods of calculating the characteristics of the polarization radiation (diffraction and transition radiation) and to compare the methods based on three approaches, the so-called, virtual photons method, polarization current method and the method of images [3].

The virtual photons method is based on the similarity of a moving charged particles field and electromagnetic pulse. That lets to establish communication between the effects produced in collisions of the relativistic charged particles with a certain system, and the corresponding effects caused by the interaction of radiation (virtual photons) with the same system [1, 4].

The radiation, arises when a particle with arbitrary speed goes through the material with randomly distributed in homogeneities, can be calculated due to using this method. Perturbing effect of the fields of the incident particle is replaced by an equivalent pulse of radiation that can be represented in the form of spectral decomposition for virtual photons. Method of virtual photons is applicable when the perturbation caused by the fields can be considered small, and due to the assumption of a small displacement of the scattering particle in process of collision.

The calculation formula for determining the spectral-angular density of radiation energy has the following form:

$$\frac{d^2W}{d\omega dQ} \sim |E_x|^2 + |E_y|^2, \text{ where}$$

1. For the case when the particle goes through the circular aperture:

$$E_x = \frac{ie}{2\pi^2 c} \frac{q}{q^2 + a^2} J_0(qa) \cos \psi, \quad E_y = \frac{ie}{2\pi^2 c} \frac{q}{q^2 + a^2} J_0(qa) \sin \psi, \quad q = k * \sin Q,$$

E_x –longitudinal component of the electromagnetic radiation field,

E_y – transverse component of the electromagnetic radiation field,

k – radiation wave vector,

a – diameter of the aperture,

c – the speed of light,

J_0 – Bessel function,

Q – polar angle in a spherical coordinate system,

ψ – azimuthal angle in a spherical coordinate system.

2. For the case when the particle goes through the slit

$$E_x = \frac{iek_x}{4\pi^2cf} \left(\frac{e^{-a_1(f-ik_y)}}{f-ik_y} + \frac{e^{-a_2(f+ik_y)}}{f+ik_y} \right), E_y = \frac{e}{4\pi^2c} \left(\frac{e^{-a_1(f-ik_y)}}{f-ik_y} - \frac{e^{-a_2(f+ik_y)}}{f+ik_y} \right),$$

k_x, k_y – wave vector components along the x axis and y axis,

a_1, a_2 – the distance from the point of entry of particle to the edges of the slit,

$$f = \sqrt{k_x^2 + \alpha^2}.$$

Image method is applied according to the real motion of particles in matter. This requires calculation of the arbitrarily moving charged particle radiation field at presence of the matter interface. Image method is based on the possibility of representing a charged particle field in the form of fields' sets of the dipoles along the particle trajectory, the representation of these dipoles images and finding arbitrarily moving charged particle field, expressed directly by the law of its motion [5, 6].

The calculation formula for determining the spectral-angular density of radiation energy has the following form:

$$\frac{d^2W}{d\omega dQ} = cR^2 |H_\omega|^2, \text{ where}$$

$$H_\omega = \frac{\omega}{c} k \Pi_\omega,$$

Π_ω – Hertz vector sum of the transverse and longitudinal polarization.

To calculate the spectral-angular density of the radiation energy is necessary to know six Hertz vectors that characterize the different components radiation of a particle dipole and its image. These expressions are quite complicated in form and not to take plenty of space they were not given in the report.

Polarization current method is based on the representation of the polarization radiation as the current field induced in the substance by the field of the moving charged particle. In the case of a perfectly conducting infinitely thin screen polarization in complete analogy with the diffraction of the "free" wave is manifested in the induced dipole moment, is considered distributed over the surface of the screen with some density [2].

For the case when the particle goes through the circular aperture:

The calculation formula for determining the spectral-angular density of radiation energy has the following form:

$$\frac{d^2W}{d\omega dQ} = \frac{e^2}{\pi^2 c} \frac{\beta^2 \text{Sin}^2 Q}{(1 - \beta^2 \text{Cos}^2 Q)} \left(\frac{a\omega}{v\gamma} \right)^2 \left(J_0(ka \text{Sin} Q) K_1 \left(\frac{a\omega}{v\gamma} \right) + \frac{1}{\beta\gamma \text{Sin} Q} J_1(ka \text{Sin} Q) K_0 \left(\frac{a\omega}{v\gamma} \right) \right)^2, \text{ where}$$

$$\beta = \frac{v}{c},$$

$$\gamma = \frac{1}{\sqrt{1-\beta^2}}.$$

\mathbf{k} – radiation wave vector,

a – diameter of the aperture,

c – the speed of light,

v – the speed of particle,

J_0, J_1 – Bessel function,

K_0, K_1 – Macdonald function,

ω – frequency of radiation,

Q – polar angle in a spherical coordinate system.

Figures 1-4 are graphs of the spectral-angular density of radiation energy for different parameters for all three methods. All graphs are given along the ordinate axis in relative units.

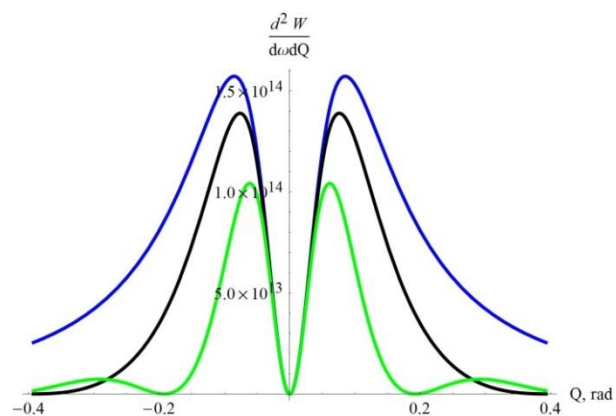

Fig 1. Spectral-angular density of diffraction radiation for virtual photons method when particles go through a circular aperture on the viewing angle Q for different hole diameters (0.5mm (green lower line), 1 mm (black middle line), 5mm (blue upper line)) $E=6$ MeV, $\lambda = 5$ mm, $a = 1$ mm, $\psi = 1$ rad.

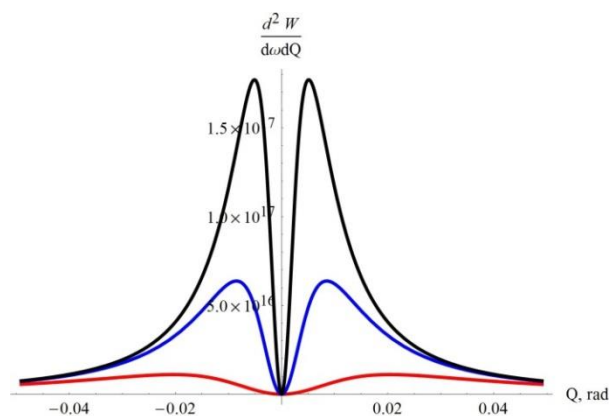

Fig 2. Spectral-angular density of diffraction radiation for virtual photons method when particles go through a slit on the viewing angle Q for different energies of the incident particle (25MeV (red lower line), 60MeV (blue middle line), 100MeV (black upper line)) $a_1 = 0,1$ mm, $a_2 = 0,9$ mm, $\lambda = 10$ mm, $\psi = \pi/2$ rad.

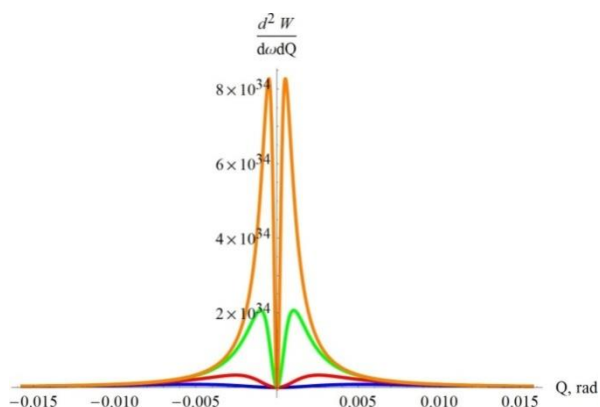

Fig 3. Spectral-angular density of the transition radiation for polarization current method on a viewing angle Q for different energies of the incident particle (200 MeV (blue lower line), 500 MeV (green middle line), 1000 MeV (orange middle line), 1000 MeV (orange upper line)). $\lambda = 5$ mm, $\psi = \pi / 2$ rad.

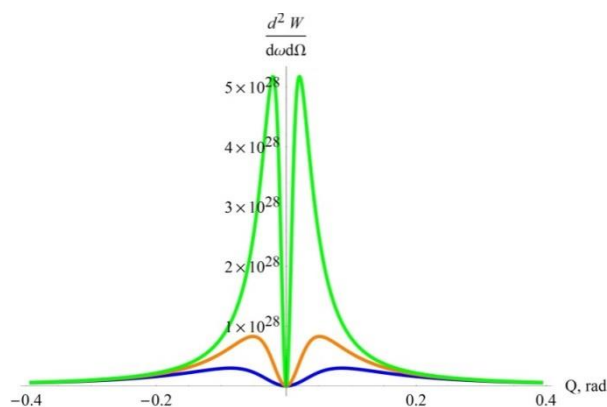

Fig 4. Spectral-angular density of the transition radiation for image method on a viewing angle Q for different energies of the incident particle (200 MeV (blue lower line), 500 MeV (orange middle line), 500 MeV (green upper line), 1000 MeV (green upper line)). $\lambda = 1$ mm.

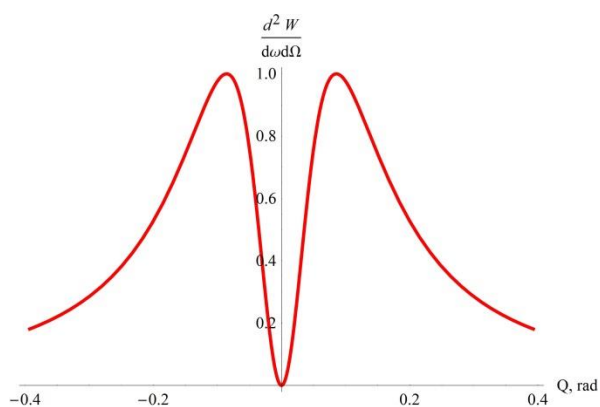

Fig 5. Normalized spectral-angular density of transition radiation for virtual photons method on a viewing angle Q
 $E=6$ MeV, $\lambda = 5$ mm, $\psi = \pi / 2$ rad.

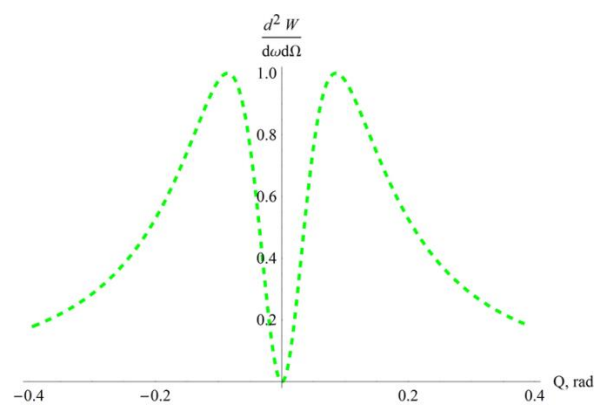

Fig 6. Normalized spectral-angular density of the transition radiation for image method on a viewing angle Q
 $\lambda = 1$ mm, $E=6$ MeV, $\psi = \pi / 2$ rad.

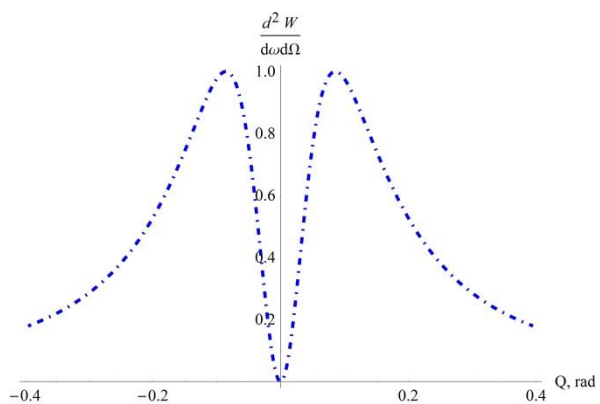

Fig 7. Normalized spectral-angular density of the transition radiation for polarization current method on a viewing angle Q

$\lambda = 5 \text{ mm}$, $E = 6 \text{ MeV}$, $\psi = \pi / 2 \text{ rad}$.

From these graphs it is clear that the obtained dependences coincide with the known distribution of the spectral-angular density of radiation at the angles. Symmetrical peaks occur in the angles $\sim \frac{1}{\gamma} = 1 - \frac{v^2}{c^2}$.

The minimum at the center is due to the interference of the radiation from the edges of the target.

With the increase in the diameter of the circular aperture (Fig 1), the spectral energy density increases as the fraction of the radiation transmitted through the aperture. With increasing energy of the incident particle the spectral energy density is also increasing at a constant emission wavelength (Figure 2, 3, 4).

Spectral-angular density distribution of the transition radiation was calculated for the same system parameters for all three methods. As it's clear from the graphs all three methods have similar distribution that means any of them can be used for the calculation. The choice of method depends on the system for which each method has been developed and the parameters of the target and the incident particle (Figure 5, 6, 7).

During the work the following results were obtained:

1. for the virtual photons method two problems were considered: passage of a charged particle through a circular aperture and passage through the slit at different initial characteristics (particle energy, wavelength) and various parameters of slit and circular aperture (dimensions, entry of the particle)

2. for the method of images we calculated the intensity of the transition radiation produced by a charged particle through the boundary between matters, depending on the viewing angle and for different particle energies.

3. for the method of polarization currents we calculated the intensity of the transition radiation produced by a charged particle through the boundary between matters, depending on the viewing angle and for different particle energies.

4. three classic methods for the analysis of problems associated were studied and applied with the interaction of charged particles with different targets, that produces the polarization radiation.

REFERENCES

1. J.D. Jackson (1999), Classical Electrodynamics, third ed., Wiley, New York.
2. D.V. Karlovets, A.P. Potylitsyn (2008), Zh. Eksp. Teor. Fiz. 133 (2008) 1197, JETP 1061045.
3. V.L. Ginzburg (1989), Applications of Electrodynamics in Theoretical Physics and Astrophysics, Gordon and Breach, New York.
4. M. L. Ter-Mikaelyan (1969), Influence of the medium on electromagnetic processes at high energies, Publisher Armenian SSR, Yerevan
5. S. A. Schelkunoff. (1939) On diffraction and radiation of electromagnetic waves // Physical Review.— Vol. 56.— 308–316 pp.
6. A.V. Nesterov, V.G. Niziev. (2005) Vector solution of the diffraction task using the Hertz vector // Physical Review E.— Vol. 71.— 046608 pp.

THE IMPLEMENTATION OF TCP/IP STACK AT THE LABORATORY DEVELOPMENT

BOARD SDK 2.0

R.A. Nurmuhametov, A.N. Pushinskaya, T.S. Chernyaeva

Scientific advisor: PhD, Associate professor Y.A. Chursin

Language advisor: Senior teacher N.V. Demyanenko

Tomsk Polytechnic University, Russia, Tomsk, Lenin str., 30, 634050

E-mail: nurruslan@yandex.ru

Annotation: *The article deals with the implementation of TCP / IP stack at the board SDK 2.0. The article contains some information about the structure of laboratory board SDK 2.0, the interface Ethernet, the organization of TCP/IP stack. In summing up the authors present a practical example of the implementation of TCP / IP stack.*

The purpose of the work is the implementation of data transfer between board SDK 2.0 and a personal computer through the organization of TCP / IP stack.

The training laboratory board SDK 2.0 is designed to study the principles of organization of microprocessor systems, structure and functioning of basic components (memory, input-output controllers, memory subsystems, etc.), obtaining programming skills of the embedded systems for various applications. Laboratory board SDK 2.0 is a functionally complete device, which has a high-performance processor core ARM7, a great variety of communication interfaces (RS232C, RS485, CAN 2.0, Ethernet, IEEE 802.15.4), a collection of input-output devices and means of communication with the operator.

The one of the communication subsystem of SDK 2.0 including a controller Ethernet LAN91C111 is the interface Ethernet. Ethernet is a family of computer networking technologies for local area networks (LANs). Ethernet was commercially introduced in 1980 and standardized in 1983 as IEEE 802.3. Since its commercial release, Ethernet has retained a good degree of compatibility. The Ethernet frame format has influenced other networking protocols. A wide range of remote communication features are possible when Ethernet connectivity is added to the embedded designs. End users benefit through cost and time savings since they can centrally monitor, control and service their embedded systems over the Internet instead of physically being there.

Each piece of information transmitted on an Ethernet network is sent in something called a packet. A packet is simply a chunk of data enclosed in one or more wrappers that help to identify the chunk of data and route it to the correct destination.

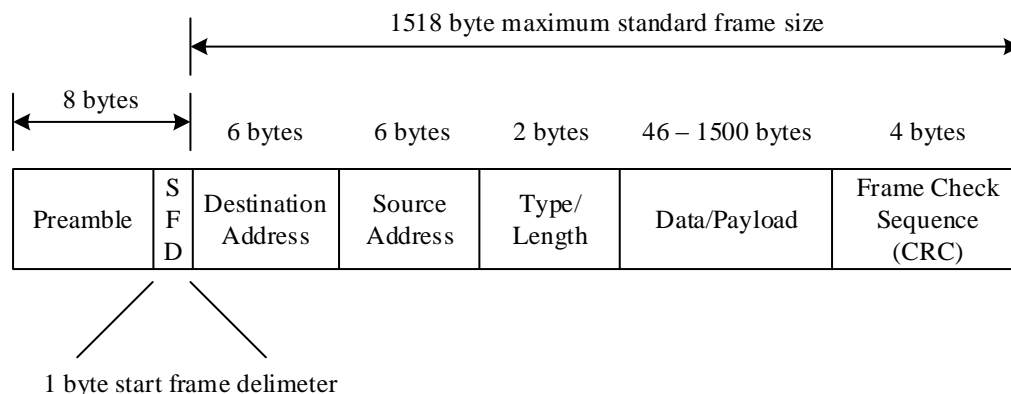

Figure 1 – Ethernet frame format

The 802.3 specification divides the preamble into two sections. The first section is a 56 bit (7 byte) field plus a 1 byte field called the starting frame delimiter (SFD). The preamble is not typically used in modern Ethernet networks as its function is to provide signal startup time for 10Mbps Ethernet signals. Modern 100Mbps, 1000Mbps or 10Gbps Ethernet use constant signaling, which avoids the need for the preamble.

Destination and Source Address: these two sections of the frame are likely the most commonly understood in that they contain the MAC address for the source “transmitting system” and the destination “target system”. The type / length field is used to identify what higher-level network protocol is being carried in the frame (example: TCP/IP) The data / payload field is what we typically consider most important as it is the data in which we are transmitting. The diagram specifies a range between a minimum of 46 bytes and maximum of 1500 bytes. The end of the frame contains a 32 bit field which is a Cyclic Redundancy Checksum (CRC). This is a mechanism to check the integrity of a frame upon arrival at its destination. The CRC is generated by applying a polynomial to bits which make up the frame at transmission. This same polynomial is used at the receiving station to verify the contents of the frame have not changed in transmission.

TCP/IP (Transmission Control Protocol/Internet Protocol) is a protocol family that is used world-wide as the standard for network communications between user processes. TCP/IP is a collection of protocols that include TCP, IP, UDP, ICMP, ARP, RARP, and others. To send data over a TCP/IP network requires four steps or layers:

- Application. Encodes the data being sent;
- Transport. Splits the data into manageable chunks, adds port number information;
- Internet. Adds IP addresses stating where the data is from and where it is going;
- Link. Adds MAC address information to specify which hardware device the message came from,

and which hardware device the message is going to.

The data exchange between the computer and SDK 2.0 is required the implementation of two sockets, one for the target host, the other for the sending host. In Ethernet domain socket is a combination of IP address and port number, which uniquely defines a single network process. To create the TCP - server the programming language C++ was chosen, and TCP - client is implemented using uVision Keil 3.0.

Figure 2 represents a general view of connection SDK2.0 and a PC to implementation the data exchange between them.



Figure 2 – General view of connection PC and SDK 2.0

As a result of this work the research of interface Ethernet was carried out. The organization of TCP/IP stack was provided by connection SDK 2.0 to PC. The data transmission between SDK 2.0 and computer performed similarly conversation between two persons. If two persons start talking at the same time, they soon discover it (collision detection). In this case, they fall silent and wait for some time, and then one of them starts talking again. Another person waiting for the first person finish talking and then he can start talking. Everyone has their own name (analog unique Ethernet-address). Every moment when someone starts talking, he called the name of the person with whom there was talk, and his name, followed by the transmission of the message.

In the completion of this work implementation of the Web server is expected. It is contribute to decision of one problem faced by embedded systems that run remotely or unattended is that of monitoring the system's status.

References:

1. Douglas E. Comer. Internetworking with TCP/IP. Vol I: Principles, protocols, and architecture. Fourth Edition. New Jersey, 1995.
2. Charles M. Kozierok. THE TCP/IP GUIDE. A comprehensive, illustrated Internet protocols reference. San Francisco, 2005.
3. William Stallings. High-Speed Networks: TCP/IP and ATM Design Principles. Prentice-Hall, 1997.
4. Fact Pandit. A TCP/IP Server written in C#. [Network resource]. – Access mode: <http://www.codeproject.com/Articles/5733/A-TCP-IP-Server-written-in-C>

NUCLEAR SECURITY CULTURE

M.V. Perminova

Scientific Supervisor: PhD, Associate professor D.G. Demyanyuk

Linguistic Advisor: Senior teacher N.V. Demyanenko

Tomsk Polytechnic University, Russia, Tomsk, Lenin str., 30, 634050

E-mail: masha199303@gmail.com

Annotation

The main purpose of this work is determination of «security culture», main ideas of this object, what and who contributes to form it. This article shows researching field, scales, importance of security culture». It describes factors which influence security, such as professional and personal qualities of the employee, relations of workers, political situation, organization history, economical situation, technological characteristics and so on.

The present paper shows the topicality of this questions and the organization which takes part in development of this concept. We consider the methods of rising «Nuclear Security culture»: international cooperation and assistance, public policy, technical equipment, rules and regulations, enforcement and punishment for preventing violations of rules and norms, informing the public and outreach,

Key words: nuclear security culture, social engineer, responsibility

Research field: nuclear industry

Related sciences: psychology, nuclear physics,

The beginning of the 21 century is the main period in understanding of the security of the nation, country and world. Accidents of the September 11, 2011 year in USA, and a string of terror attacks in Russia shows us there is no limit of terrorism, so people need to input conception of «Nuclear Security Culture», which have become the most important problem of nuclear power in our days. This way man can protect themselves from this danger.

The main objective of this research is to understand who real nuclear engineer is, which characteristics, responsibilities he should have for providing security.

In this article we will give definition, main ideas of «Nuclear Security Culture», influencing factors, relevance and importance of this problem, the ways of reaching maximum level of «Nuclear Security Culture».

First of all that needs to be said is what «Nuclear Security Culture» is. International Nuclear Safety Group (INSAG) «Nuclear Security Culture» is defined as: «The assembly of characteristics, attitudes and behavior of individuals, organizations and institutions which serves as a means to support and enhance nuclear security».[6]

Follow this definition, «Nuclear Security Culture» covers all activities of nuclear power station, not just operation of equipment, so it is the most important clause of safety.

It is vital to note that «Nuclear Security Culture» has more moral character, it covers legislative control. Moreover level of system efficiency depends on motivation, professionalism and understanding of responsibility which worker should have.

Foundation of «Nuclear Security Culture»

«Nuclear Security Culture» implies:

- compliance with rules and regulations of the security regime, from the Head to employee
- correct use of the technological protection, keeping operative condition and modernization
- keeping security regime at manufacture
- staff motivation
- awareness and understanding of responsibility for all kinds of activities on the nuclear power station,
- awareness of staff confidence in the necessity and effectiveness of activities related to this issue. [1]

Skills of professional working with nuclear material is absolutely one of the most important factors of security of enterprise. But all of these criteria are impossible without strict rules, norms, procedures which everyone should follow. «Nuclear Security Culture» is one of the main conception of International Atomic Energy Agency(IAEA). There is vigorous activity in extension of this problem and giving publicity and topicality in the world. In 2004 year IAEA has published the «Code of Conduct on the Safety of Radiation Sources». This document is a guide for nuclear countries, for purposes of development and agreement of political question in sphere of safety and security of radioactive sources; this code determines behaviors, norms, questions which participating countries should follow for security. [5]

Factors affecting Nuclear Security Culture

There are some factors which influence the efficiency of «Nuclear Security Culture»:

Professional and personal qualities of the employee: it is supposed to be, that employee actively takes part in eliminating the threat of safety nuclear material. Men should understand all responsibility which he has, understand the scale of the threat, result and repercussion of his behavior. He needs to follow all rules and strict security model in case of threat. Trying to use all equipment in the right way and keep it in work condition. Having all this points base the platform for forming strong mechanism of security culture, which consists of four components: leadership of head; effective policies and procedures, personnel quality, improving of professional training.

Relations between workers: the most serious problem of nuclear power stations, facilities of nuclear fuel cycle, research reactors misses insider threat. People who work and trust each other can easy have a conspiracy with terrorists and steal some nuclear materials. This problem is typical for countryside inside of a country, where people know each other for a many years and work together all their life

Political situation: the most important role in development of nuclear security culture is played by political situation as inside of country as in the world. The government should be the most interesting in questions of safety of nuclear materials. Government needs to be demanding and give motivation for head of power station and employee too. There must be rules and norms and if it is a break, the breaker will have the strict penalty. As for this question in the world scale, there should be such a concept as global cooperation. Only after uniting countries can overcome the terrorism and as a result the level of security increases. Basic standards and criteria are needed to be understood in each country in the same way, independently of social and economical and political differences.

Organization history: realization of criteria of security depends on common professional culture and

events during all existence of enterprises; it means the number of violations, theft of nuclear materials, number of internal violations and so on.

Economical situation: financing of nuclear security program helps employee of this sphere both materially and morally. It determines the importance of security questions and increases motivation of young specialists.

Technological characteristics of the enterprise: for having maximum level of effective security system not just professionalism of employees must be considered, but equipping too. Just interaction of this two points helps to reach maximum results. A technological characteristic includes sensors and instrumentation which signal about penetration into the protected area, surveillance cameras, checkpoints, access control system and so on.

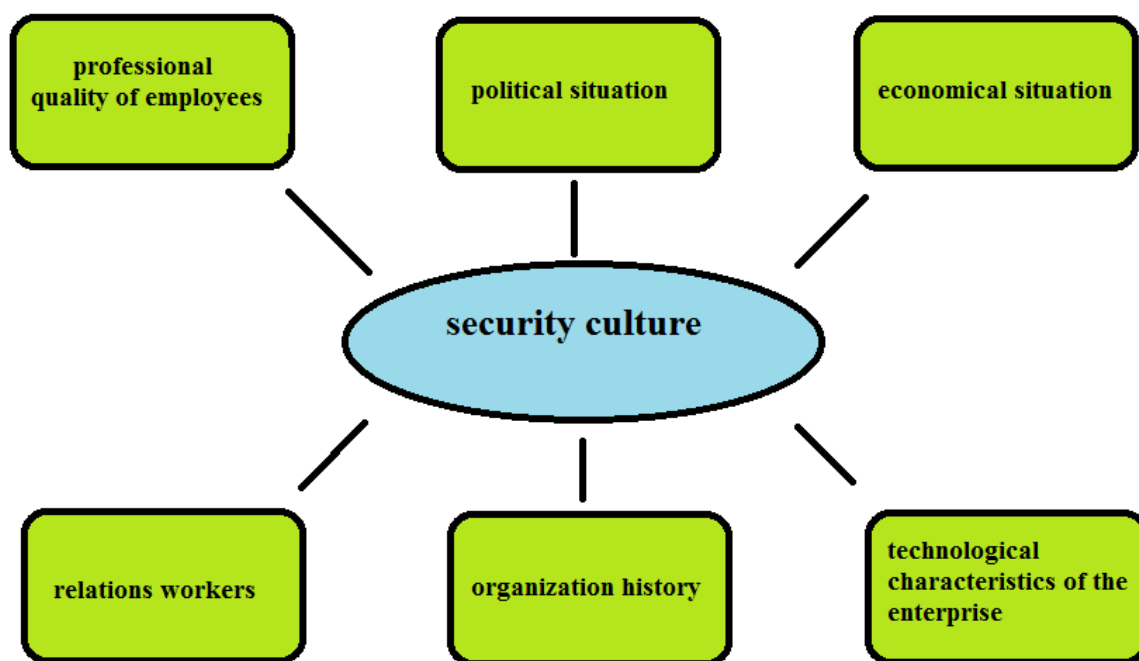

Pic. 1. Factors affecting the nuclear security culture

Topicality of «Nuclear security culture».

The topicality of security problems in our days needs to be noticed. 20 century is a century of progress, development of innovation technologies, including nuclear energy. That's why people can't miss terrorist movements, trying to get nuclear weapon. So because of this reasons «Nuclear security culture» needs to be developed on a line with progress. As a result people can find the solutions for such problem as high probability of nuclear terrorism, high probability of nuclear terrorism, understanding of responsibility for work from workers of nuclear power station, prevention accidents on nuclear power station, maximum level of safety, reliability and efficiency of using technological and human resources.

In the report «Basic Safety Principles for Nuclear Power Plants» the concept «security culture» was named like decisive for getting perfection of nuclear safety and also one of the fundamental principles of control.[4]

Rising of «Nuclear security culture»

There are some ways of working for rising of security culture which need to be distinguished.

1. International cooperation and assistance.

Cooperation of countries with each other helps to get experience and make the common concept. In addition International Atomic Energy Agency is carrying out vigorous activity in this sphere. Since 2001 year it has been more than 60 training seminars and conferences for security of European, Asian, countries, Latin America and Africa. Also International Physical Protection Advisory Service (IPPAS) was created.

2. Public policy.

The Head and employees of nuclear power plant will not be interested in questions of security, if the government of country will be loyal to the problem of non-proliferation of nuclear materials and security in general. First of all the government must have this questions like foreground.

3. Technical equipment

Equipment of this area needs to be available for enterprises, corresponds with national and international standards. If people provide automation systems it will help to lower percent errors of workers.

4. Rules and regulations

There should be strict texts of rules, norms, guidelines and instructions. Moreover, legislation is also important.

5. Enforcement and punishment for preventing violations of rules and norms

Violations must be strictly punished, responsibilities must be strictly defined. This will reduce the percentage of potential violators.

6. Informing the public and outreach

Government should inform society about nuclear energy. As a result people will contact with government and give all information which they have, for instance strange person which they saw on the territory of their place of living.

Results

The result of this research is inference as «social engineer». Social engineer is some sample, image of a man, who has personal qualities such as sense of responsibility for all activities. World needs the development concept of social engineering, with purpose to get progress and strengthening of «Nuclear security culture».

Conclusion

The concept of «Nuclear security culture» follows from the process of security and represents the efficiency of each element and all process in general and readiness of the process to detect threats and control the risks. All these aspects show the level of security in the world.

References

1. Khripunov I., Holmes J. (2004) Nuclear Security Culture: The Case of Russia. Center for International Trade & Security - University of Georgia, from http://www.nti.org/media/pdfs/analysis_cits_111804.pdf?_id=1316466791
2. Mashin V. A.(2014) Sovremennie osnovi koncepcii kul'tury bezopasnosti, from

<http://mashinva.narod.ru/arch/PSY42.pdf>

3. IAEA. (1996) Nuclear Power Plant Personnel Training and its Evaluation. A Guidebook. Technical Reports Series, from

http://www-pub.iaea.org/MTCD/Publications/PDF/trs380_web.pdf

4. IAEA. (2006) Safety fundamentals principles. for Nuclear Power Plants, from

http://www-pub.iaea.org/MTCD/publications/PDF/Pub1273_web.pdf

5. IAEA (2004) Code of Conduct on the Safety and Security of Radioactive Sources, from

http://www.logwell.com/tech/reg/IAEA_codeofconduct.pdf

6. IAEA(2008) Nuclear Security Culture, from

http://www-pub.iaea.org/MTCD/publications/PDF/Pub1347_web.pdf

APPLICATION OF THE PROGRAMMABLE LOGIC CONTROLLER GLOFA-GM7 IN INDUSTRY

A.O. Pletnev, D.S. Fedorov

Scientific advisor: Assistant A.A. Denisevich

Language advisor: Senior teacher N.V. Demyanenko

Tomsk Polytechnic University, Russia, Tomsk, Lenin str., 30, 634050

E-mail: cahek4293@mail.ru

Annotation. The paper discusses the application of PLC in industry and also the different parts of typical scheme and methods of connection it and programming. The paper is provided with 5 figures.

The purpose of our research to familiarize with the structure of PLC GLOFA-GM7, to explore ways of further use of the PLC in various industries, in particular, as a process control device depending on the temperature.

From the dawn of humanity, people have tried to simplify their work. Ancient people made tools out of sticks and stones. People of medieval smelt iron tools. Later steam engines and assembly-line production were invented. Now, in the 21st century, mankind tries to simplify their labor, but also people try to do most of their activities using machines. 21 century is the century of high technologies. Almost all areas of production are controlled by automatic control systems. The main elements of the ACS are MC and PLC. In our work, we consider one of the PLC - GLOFA-GM7.

What is a PLC? PLC or Programmable Controller is a digital computer used for automation of electromechanical processes, such as control of machinery on factory assembly lines, amusement rides, or light fixtures. PLCs are used in many industries and machines. Unlike general-purpose computers, the PLC is designed for multiple inputs and output arrangements, extended temperature ranges, immunity to electrical noise, and resistance to vibration and impact. Programs to control machine operation are typically stored in battery-backed-up or non-volatile memory. A PLC is an example of a hard real-time system since output results must be produced in response to input conditions within a limited time, otherwise unintended operation will result.

Before the PLC, control, sequencing, and safety interlock logic for manufacturing automobiles was mainly composed of relays, cam timers, drum sequencers, and dedicated closed-loop controllers. This system was very massive and expensive. To change the logic, electricians needed to individually rewire relays. Early PLCs were designed to replace relay logic systems and simplify the management of ACS. Nowadays PLC is used in almost all spheres of production.

Glofa-GM7 - modular PLC. The basic meaning of modular PLC has only one control module and you can easily adapt your PLC to different specific task, using a variety of additional I / O modules, relay modules, communication modules (Cnet, Ethernet), and others.

In our work we use two units: a control module G7M-DR20A, and A/D-D/A I/O Combination Module G7F-ADHA. Let's consider the wiring diagrams of each.

20-point base unit G7M-DR20A

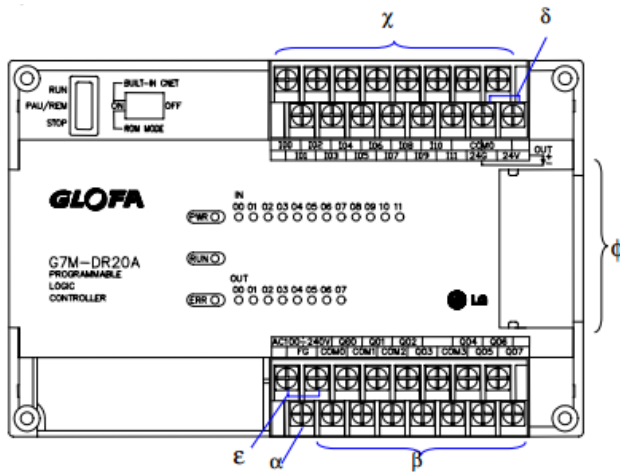

No.	Names
	Frame and line ground
β	Output circuit
ε	Block for supply (AC 100-240V)
δ	24V DC power supply(can be used to supply the module)
χ	input circuit
φ	Expansion Cable Connecting Terminal

Figure 1. Control module G7M-DR20A

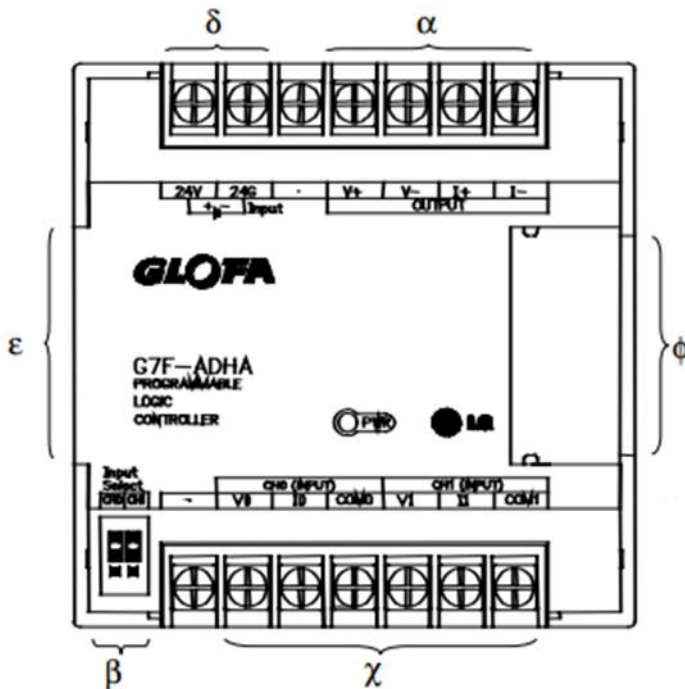

No.	Names
α	Analog Output Terminal
β	Analog Input (Voltage/current) selecting jumper pin
ε	Expansion Cable
δ	External Power Supply Terminal (DC24V)
χ	Analog Input Terminal
φ	Expansion Cable Connecting Terminal

Figure 2. A/D•D/A I/O Combination Module G7F-ADHA

Connection between the PC and the PLC carried out via RS232C interface and ModBus protocol.

RS-232 is a standard for serial communication transmission of data. It formally defines the signals connecting a DTE (data terminal equipment) such as a computer terminal, with a DCE (data circuit-terminating equipment, originally defined as data communication equipment), such as a modem. The RS-232 standard is commonly used in computer serial ports. The standard defines the electrical characteristics and timing of signals, the meaning of signals, and the physical size and pinout of connectors. It is recommended to use the standard DB-9 for connecting.

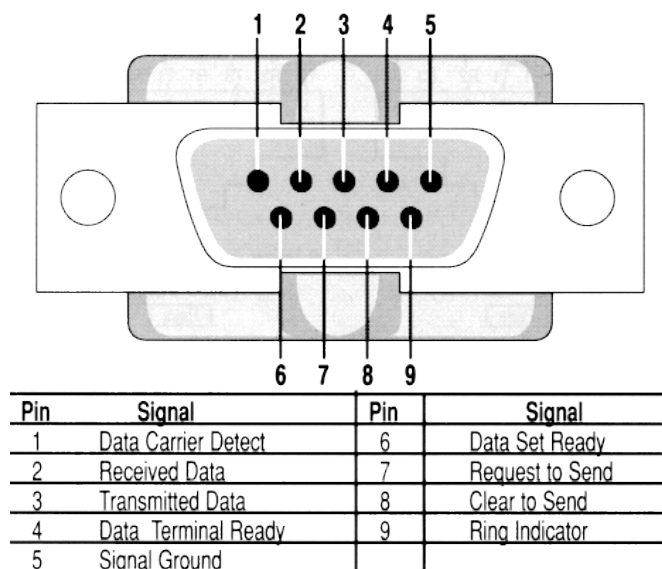

Figure 3. DB-9 connector

For programming this PLC, we use GMWin software. In this program we can choose one of three available programming languages. We consider one of them. It's a ladder diagram language. Syntax of this language is convenient for replacement of first logical circuits, formed on the relay technique. GMWIN is focused for engineers working in the automation industry. It provides intuitive interface of controller logic. It facilitates not only the task of programming, but also rapid troubleshooting in the equipment, connected to the controller. In this picture you can see some example of program.

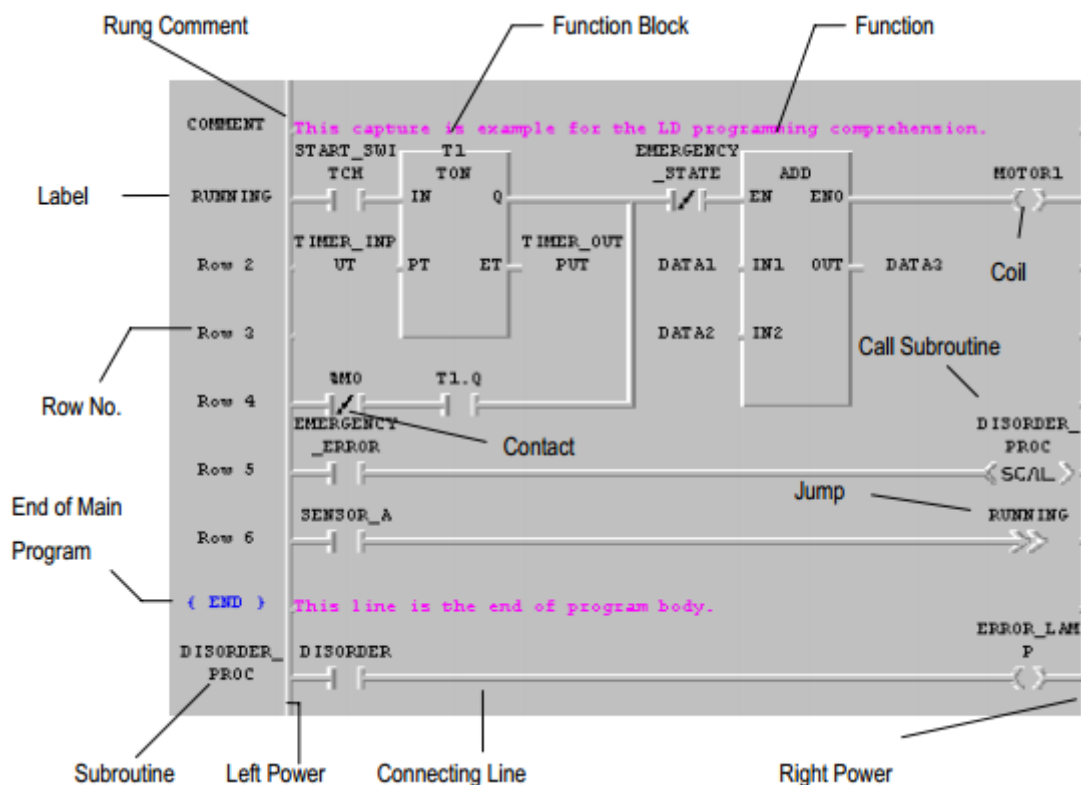

Figure 4. GMWin software

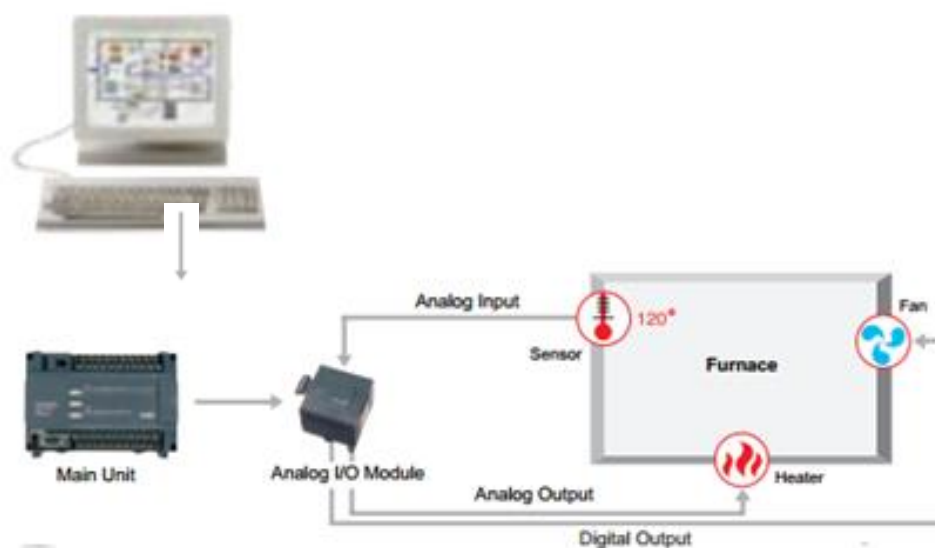

Figure 5. Typical scheme of use the PLC in industry

In this scheme we can see how PLC GLOFA-GM7 can control the temperature in furnace, for example. Data from temperature sensor arrive on Analog I/O module. Main unit takes this data from it, and analyzes it. Depending on the received results, GLOFA forms control action, which manages the temperature in furnace.

Trace Mod

For visualization of process in the scheme we used the most perspective Russian SCADA system Trace Mode. The result of the use of this package is Project. Project is the set of interpreted files. In this file the control algorithms for automatic control of different unit of ACS are programmed.

At the moment we are performing the connection of thermistor to PLC, which allows to measure the temperature in the investigated object. The received data is processed in the PLC and handled according to algorithm, written on GMWIN. The temperature is also sent to the PC. In the future it is necessary to consider the devices to regulate temperature and to develop an algorithm that allows to manage these devices.

THE MODIFICATION OF POLYTETRAFLUOROETHYLENE SURFACE USING HYDROXYAPATITE COATING DEPOSITED BY RF-MAGNETRON METHOD

T.S. Pryamushko, I.Yu. Grubova, R.O. Banin

Scientific Supervisor: Dr. R.A. Surmenev

Linguistic Advisor: PhD. N.V. Demianenko

Tomsk Polytechnic University, 634050, Russia, Tomsk, Lenin str., 30

E-mail: tatyana.pryamushko@mail.ru

The osseointegration rate of the polytetrafluoroethylene (PTFE) dental implants is related to their composition and properties of surface. Osteoconductive calcium phosphate coatings promote bone healing and apposition, leading to the rapid biological fixation of implants. The deposition of the hydroxyapatite (HA) coating on the PTFE surface by the RF magnetron sputtering method and the influence of this modification on the wettability, and physicochemical properties are presented in the present work.

Nowadays polymers are widely used in many industries. Polymers have high resistance to abrasion, that enables a high withstand load even in corrosive environments. These characteristics of polymer materials make them attractive to use in certain conditions. One of the most successful polymers used for implants is polytetrafluoroethylene (PTFE) $(-C_2F_4-)_n$. This material is non-toxic, chemically resistant and has a high biocompatibility with the human body [1-2]. However, PTFE is bioinertness and it weakly affects bone growth *in vivo*, which is rather important in the initial postoperative period. In order to enhance the rate of implant osseointegration, surface modification was made by applying a thin coating based on hydroxyapatite (HA). This coating has bioactive properties: chemical composition of HA on 90% similar to the composition of human bone. Coatings were formed by high-frequency (rf) magnetron sputtering. RF Magnetron sputtering allows obtaining thin coatings with high adhesion and controlled stoichiometric ratio of elements in the deposited coating.

The aim of this work was the surface modification of PTFE due to using RF magnetron sputtering of HA coating; study of the surface modification effect on wetting angle and surface free energy (SFE) of PTFE .

The starting material was porous PTFE (20x20x1 mm³) of "Экофлон" which is used to replace bone defects and orbit. This material is chemically inert, clinically tested and already used in medicine.

HA powder – $Ca_{10}(PO_4)_6(NO)_2$, was obtained for the target due to mechanochemical method. Target for sputtering (Ø220 mm, thickness 10 mm) was prepared by ceramic technology: powder pressing was made at a pressure of about 70 MPa, and then annealing at a temperature of 1100°C for 1 hour in air was used. HA coating deposition was carried out in different regimes at a working pressure of 0.4 Pa and a grounded substrate holder (GS) using fully automated installation 08PHO-100T-005 RF-magnetron source (5.28 MHz) (Table 1).

The investigation of wettability and SFE was carried out by EASYDROP equipment (KRUSS) with software DSA1.

IR-spectra of the initial and modified samples were recorded on a Nicolet 5700 firm Thermo Electron Corporation (USA), which allows obtaining absorption spectra, reflection and transmission of molecules in the

infrared spectral region (4000-400cm⁻¹). The results were obtained in the Scientific-Analytical Center of TPU.

Table 1.

Labeling of the samples

Processing mode	Lable
The unmodified material	PTFE_1
500W; 120 min	PTFE_5_2_HA
300W; 120 min	PTFE_3_2_HA
300W; 240 min	PTFE_3_4_HA
300W; 360 min	PTFE_3_6_HA

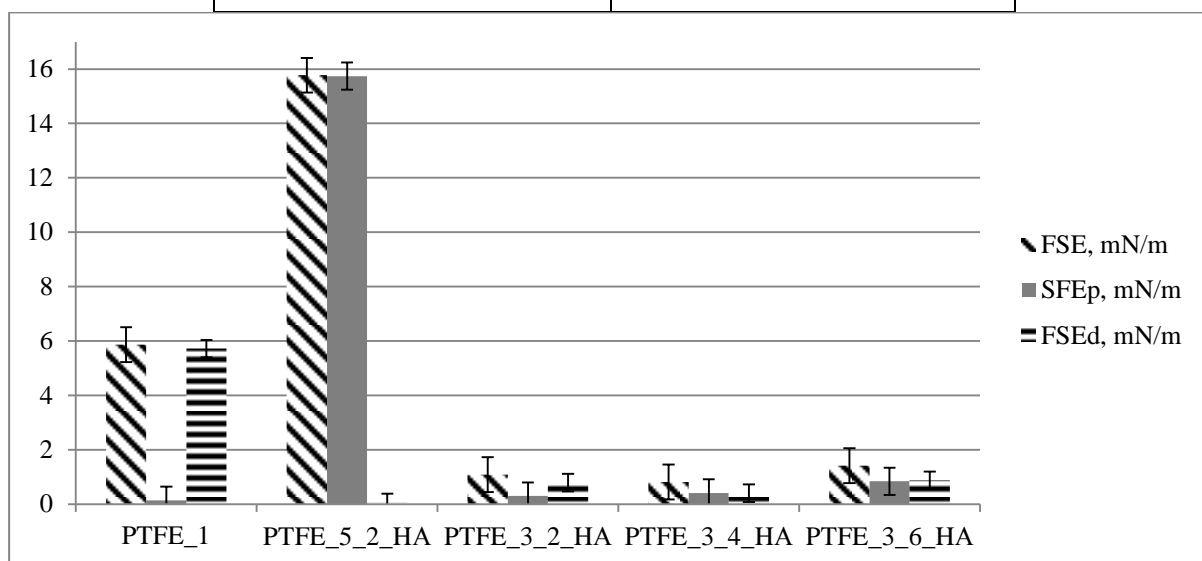

Fig.1. Values of surface free energy of the initial and modified samples

After PTFE modification by HA coating sputtering, sample surface became more hydrophobic in the case of treatment at 300W power for 4 during 6 hours: water contact angle increased on 5-6° (from 139,23° to 144,16° for PTFE_3_4_HA and to 144,53° for PTFE_3_4_HA), SFE data of the samples decreased in 6-times (from 5.86 mN/m to 0.81 mN/m and for PTFE_3_4_HA to 1.41 mN/m for PTFE_3_6_HA), the polar and dispersive components of it are equal for both samples. However, the PTFE_5_2_HA sample has shown more hydrophilic properties: deionized water contact angle of surface decreased on 35,3° compared with the unmodified material and equal to 103,93°. Moreover the SFE of PTFE_5_2_HA sample increased in 3 times (from 5.86 mN/m to 15.77 mN/m) due to its polar component (Figure 1).

Using the contact angle values two curve of dependence between angle and treatment power, angle and treatment time were plotted. Figure 2a represents the dependency of the contact angle and the treatment time for the power of 300W - increase in time led to growth of the wetting angle from 132° to 143°, this fact indicates the surface hydrophobicity.

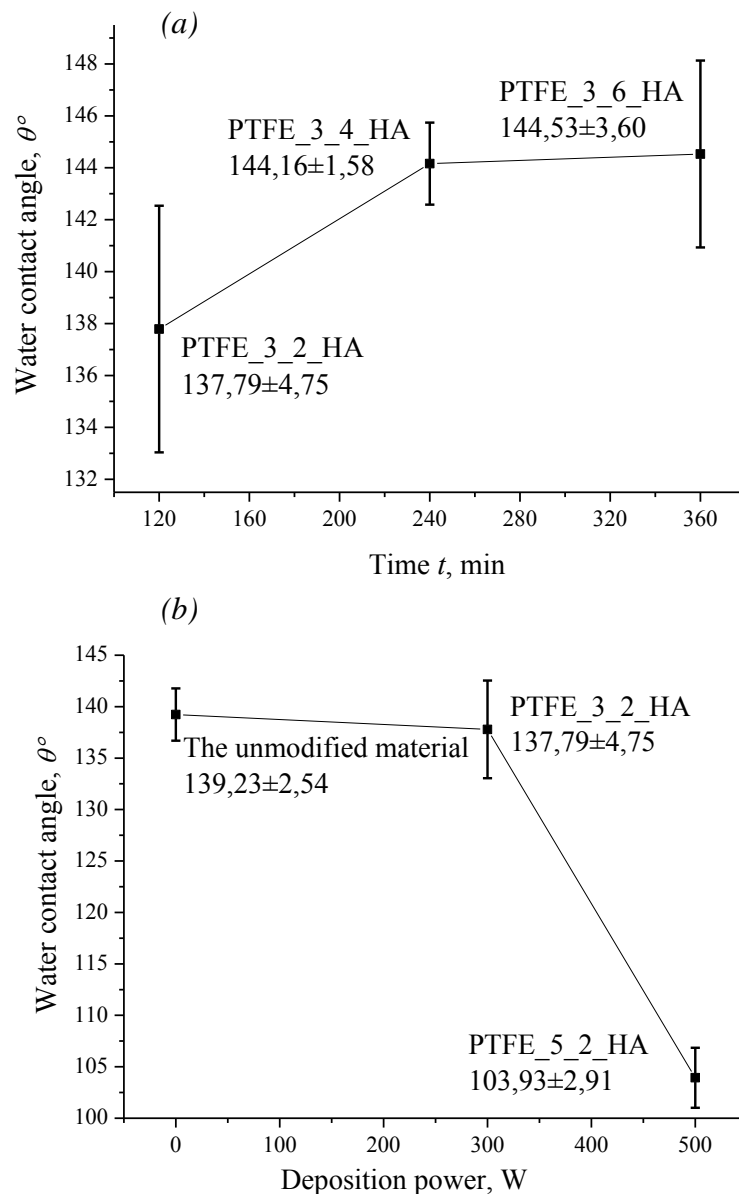

Fig.2. Graphics, depending on the contact angle: a) the time for sample processing power of 300 W and b) the processing power of the samples for time 120 min.

Figure 2b shows the dependence between the contact angle water and deposition power - the power increasing led to the decreasing of the contact angle from 139° to 104° . The highest decrease of contact angle (on $35,3^\circ$) was observed for the sample treated at a power of 500 W for 2 hours. Sample modified at 300 W for 2 hours almost did not change the value of the contact angle (from $139,23^\circ$ to $137,79^\circ$).

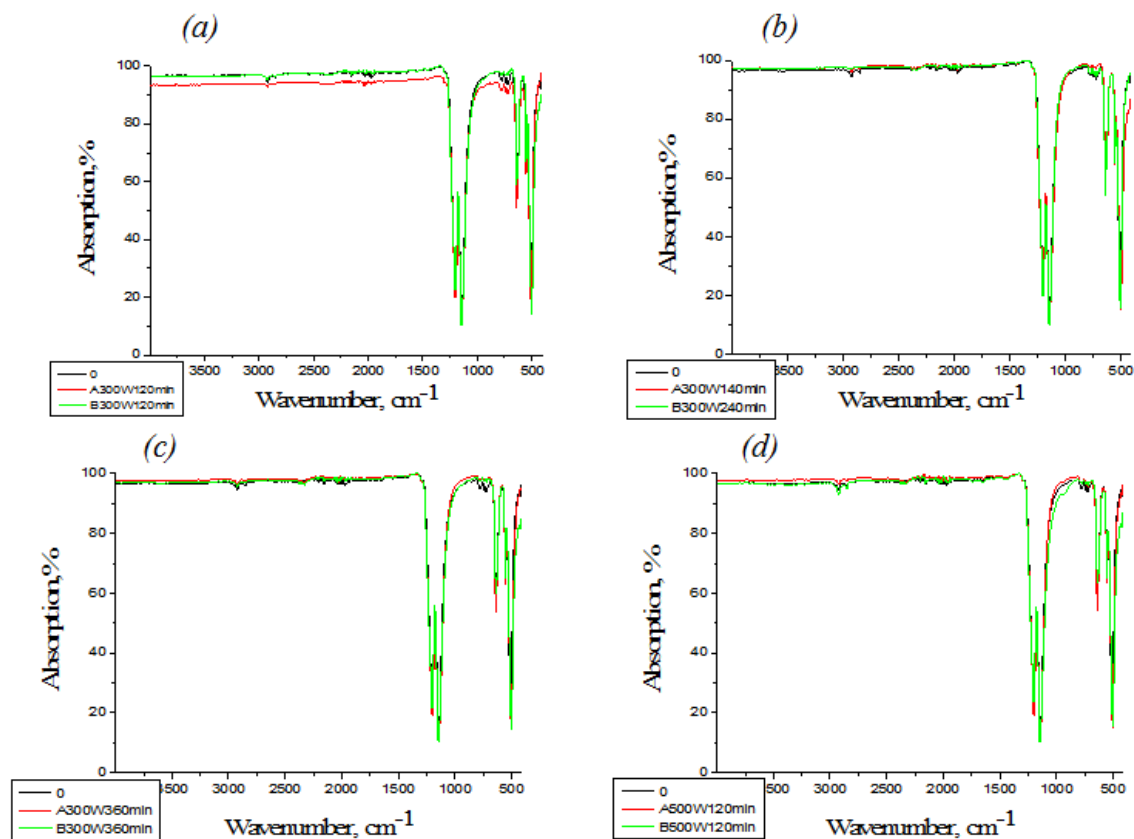

Fig.3. IR spectra of PTFE samples modified in different regimes: a - PTFE_3_2_HA; b - PTFE_3_4_HA; c - PTFE_3_6_HA; d - PTFE_5_2_HA. 0 – initial samples, the red line A is uncoated side of modified sample, the green line B is coated side of modified sample.

Fig. 3 shows the most intense bands relate to the stretching vibrations of CF_2 (1200 and 1144 cm^{-1}) and the vibration ν (SS) in the form of inflection at $\sim 1233\text{ cm}^{-1}$. Rolling oscillations $\gamma\omega$ (CF_2) appeared at 638 cm^{-1} . The bands at 552 and 505 cm^{-1} characterized the deformation of pendulum oscillations CF_2 -groups.

Investigation of PTFE surface images after deposition HA coating showed that molecular composition of the surface was not significantly changed, the spectral bands of the typical oscillations of the main structural fragments HA: RO_4^{3-} orthophosphoric groups at 570 cm^{-1} , 601 cm^{-1} and 1031 cm^{-1} was not detected (Fig. 3). The spraying process should lead to partial loss of the OH groups at 631 and 3571 cm^{-1} , which is also not found for all deposition conditions [5].

Thus, the influence of PTFE surface modification using different power and time due to the deposition on final wettability was studied. Analysis of the data has led to the conclusion that to make the surface of PTFE more hydrophilic by RF magnetron sputtering of the HA coating it is necessary to vary the output value of power near 500 W . Moreover, the time of the treatment have to be reduced.

The study was supported by a grant and scholarship of the President of the Russian Federation SP-

6664.2013.4 and МК-485.2014.8, the Russian Foundation for Basic Research (13-08-98082, 14-08-31027 and lightning).

REFERENCES

1. Biomaterials science: an introduction to materials in medicine. 2nd edition / ed. by B.D. Ratner, A.S. Hoffman, F.J. Schoen, J.E. Lemons. San Diego: Elsevier Academic Press, 2004. – 851 p.;
2. Rebinder P.A., Vlodayets I.N., Physicochemical mechanics of porous and fibrous particulate structures. - Riga, 1967. 5 - 40;
3. Shtansky D.V., Bashkova I.A., EA Levashov etc. Multifunctional nanostructured coatings for implants, working under load // Reports of the Academy of Sciences. - 2005. V. 404. - № 2. - 1-4;
4. Poncin-Epaillard F., Legeay G.. Surface Engineered Polymeric Biomaterials with Improved Biocontact Properties. Journal of Biomaterials Science Polymer Edition, 2003. – V.14, 1005 p.;
5. M.A. Surmeneva, RA Surmenev, IA Hlusov, VF Pichugin, ME Konischev, M. Epple. Calcium phosphate coating created by rf-magnetron sputtering hydroxyapatite: osteogenic potential in vitro and in vivo. Journal Tomsk Polytechnic University. – 2010. V. 317 - № 2.

NEW TRENDS IN GLOBALIZATION OF SCIENCE AND ENGINEERING EDUCATION

N.D. Turgunova

Scientific Supervisor: PhD. A.N. Aleinik

Linguistic Advisor: PhD. V.V. Verhoturova

Tomsk Polytechnic University, Russia, Tomsk, Lenin str., 30, 634050

E-mail: ousa@rambler.ru

Annotation

Three decades ago most research and design were conducted in each country independently. But the world has become quite different since then. Global changes in technology and society changed the concept of an engineer. There is the need for engineers who can work effectively in changing global and technical environments. Less interest has been paid to the globalization of science and technology. This article reviews the stimulus, that impact the engineering profession and gives the recommendations concerning the profession of engineering, the technology and innovation.

Introduction

Globalization may be thought of initially as the widening, deepening and speeding up of worldwide interconnectedness in all aspects of contemporary social life, from the cultural to the criminal, the financial to the spiritual [1]. The impact of globalization on the economy and culture is immense. It can be seen in the manufacturing sector, finance and energy. Foreign investments and ownership of business operations in many countries are growing. The world's economy is driving towards multinational corporations. The competitiveness shows significant changes in economy resulting from increasing globalization. The United States is today a net importer of high-technology products. Its trade balance in high-technology manufactured goods shifted from plus \$54 billion in 1990 to negative \$50 billion in 2001 [2]. Engineering education must not only face the challenges in a global business but it must also cope with cultural changes. Innovation is based on collaborative knowledge and global knowledge sharing. With the rapid change of technology, profession boundaries have become wider. Integration in technology and engineering has become very important. Pool states, "Look closely at any technology today, from aircraft to the Internet and you'll find that it truly makes sense only when seen as part of the society in which it grew up"[3]. Demographics and rapidly evolving technologies are the most driving forces in the role of engineering in society. Rapidly changing technology requires far broader skills than simply the mastery of scientific. Thus, the students are beginning to understand, that the changes will provide opportunities in their careers. As a result, the education must prepare the students more effectively. The importance of national security demands a new priority for engineering research. But the students are less interested in scientific and engineering careers nowadays. It raises serious problem about current approach to engineering.

Globalization and Engineering Technology

The engineering technology education mainly includes the usual skills in writing, oral communication, science, math and technology. The most modern practice today could be obsolete in the nearest future. So it would be more important to teach students how to implement new technologies, rather than teaching them

the current technology. The graduates must be competent in nanotechnology, green manufacturing, renewable energy, biotechnology, or some other yet undefined technology. More over, the skills have to be transferable from one industry to another. In addition to technical skills, experiences in entrepreneurship and leadership is very important. Educational programs must share the relative importance of fundamentals, technical specialization and other non-technical skills. Education at least as delivered by most of the nation's colleges, universities and technical schools is no longer quite the economic cure-all it once was, nor the guarantee of financial security [4]. The engineering education needs a fresh start and teaching engineers to think, in the broadest, cross-disciplinary sense, is critical [5]. Consider, for example the changes in the training programs of one the largest universities in the United States, Arizona State University (ASU). Within ASU, the Center for Asian Studies hosts a plethora of activities, including teacher training, curriculum development, public symposia and exhibitions related to global/Asian issues. In particular, ASU's presence in China is intended to "secure a unique and enduring niche in higher education, research and policy in China," with projects and partnerships in 11 different Chinese cities and regions [6]. Students from Peru, Thailand, Taiwan, Mexico and India continually interact with US-born students, creating a living presence and awareness of globalization within the department on a day-to-day basis.

India started construction of new institutions two decades ago to build a chain of Indian Institutes of Technology, that now produce the talented scientists, engineers and managers. China's leaders, while starting only a decade ago, are more focused to train young people in the science and technology skills necessary to produce world-class scientists and engineers. Perhaps because Chinese leaders have backgrounds and experience in science and engineering themselves (unlike American leaders, most of whom have law and business backgrounds), they also place a far higher priority on engineering research and education [7].

Results

Modern economy is a knowledge-driven. Advantage in technological innovation requires leadership in engineering research to bridge scientific discovery and practical applications. It follows that engineering education must exploit knowledge and technological innovation. To compete with talented engineers in other nations the beginner must be able to add significantly more intellectual span than his counterparts abroad. It is very important to elevate the status of the engineering profession and to attract outstanding students. Therefore the universities must provide the opportunity for significantly broadening the educational experience of students. More over the engineering profession must achieve the higher status such as law and medicine. To achieve these, some objectives for engineering practice and education must be performed.

1. Engineering societies should strive to create a guild-like culture in the engineering profession to react to market pressures.
2. It is very desirable, that the government launch a number of Discovery Innovation Institutes at universities to link fundamental scientific discoveries with technological innovations. This will allow to build the knowledge base for new products, to meet the needs of society.

3. The higher education working closely with industry should offer practice-based opportunities for the post-baccalaureate level as the entry into the engineering profession. Undergraduate engineering should be reconfigured, providing the students with more flexibility with the goal of preparing them for a further learning rather than professional practice.
4. Because of rapidly accelerating technologies it is essential to create lifelong learning approach for practicing engineers. This will require a significant commitment by educators, employers and professional societies.
5. It is very important to bring all resources in the engineering community to achieve a racial, ethnic and gender diversity.

Conclusion

Globalization appears to be complicated in many respects. Economics calls for leaders who are able to understand design, operations and supply chain systems. The students must have the thinking abilities to assimilate data and information from multiple sources to make wise decisions. But academia does not change easily. There is the need in an understanding of what to change to. All these actions will meet resistance from many companies, because they continue to seek low-cost engineering talent. Unlike the professional guilds that captured control of the marketplace such as medicine and law the great diversity of engineering disciplines continues to generate a conflicting objectives that inhibits change.

References

1. Manfred Steger *Globalization: A Very Short Introduction* Third Edition 2013 p.176.
2. *Rising Above the Gathering Storm: Energizing and Employing America for a Brighter Future*, Committee on Prospering in the Global Economy of the 21st Century: An Agenda for American Science and Technology, National Academies Press, 2006, pp 13.
3. Pool, R., (1997). *Beyond Engineering: How Society Shapes Technology*. New York, Oxford University Press.
4. Gosselin, P.D. (2006). "That Good Education Might Not Be Enough," *latimes.com*, March 6. <http://www.latimes.com/news/nationworld/nation/la-na- outsource6mar06,0,4152173.story?coll=la-story-footer>
5. Grasso, D. (2005). "Is it Time to Shut Down Engineering Colleges," <http://www.insidehighereducation.com/views/2005/09/23/grasso>, 23, September.
6. ASU in China, <http://www.asu.edu/china>, accessed 3-17-2006.
7. Friedman, Thomas. *The World Is Flat: A Brief History of the 21st Century*. New York: Farrar, Strauss and Giroux, 2005.

APPLICATION OF THE VEGA-2 PROGRAM DURING CONSTRUCTION OF EFFECTIVE SECURITY SYSTEMS

Y.S.Vahrusheva

Scientific Supervisor: PhD, Associate professor B.P.Stepanov

Linguistic Advisor: Senior teacher N.V. Daneykina

Tomsk Polytechnic University, Russia, Tomsk, Lenin str., 30, 634050

E-mail: julia_vach@mail.ru

Abstract

Securing nuclear materials is paramount. State physical protection systems provide a single system for planning, coordination, monitoring and implementation of the technical and organizational measures for the timely detection of unauthorized activities and prevent them. Physical protection should be provided at all stages of design, construction, operation and decommissioning of nuclear facilities, as well as any handling of nuclear materials and radioactive substances.

The aim of this work is to create a hypothetical object, with which you can get the necessary data to assess the effectiveness with using the software "Vega-2."

Introduction

Technical means allow providing early detection of unauthorized violator, control authorized access to an object, monitoring the situation, so as part of a physical protection system they have a special role. Selection of the optimal composition of elements of PPS for a particular object in the design process is carried out through a systematic approach using a variety of performance criteria the system will perform its primary function. In this evaluation of the effectiveness of PPS is mandatory.

Evaluating the effectiveness of the security system is based on quantitative or qualitative determination of the ability of the threats identified in the analysis phase of vulnerability.

The work was aimed at evaluating the effectiveness of PPS is to evaluate the ability to provide security for physical protection from external and internal threats, taken from the analysis of the vulnerability of nuclear objects, by the repression of unauthorized violator.

Development

The main objectives in assessing the effectiveness of PPS of nuclear objects are:

- identifying the elements of PPS, overcoming the offender who is most likely to theft of nuclear materials (NM) or sabotage at nuclear facilities (NF) of the object;
- Consideration scenarios violator aimed at stealing or sabotage of nuclear materials and to identify the most probable of them;
- Identification of vulnerabilities existing PPS formally meet the requirements established in the regulations;
- Analysis of the causes of vulnerabilities in PPS;
- Assessment of the likelihood of certain preventive actions violators guard force acting on the alarm

when internal and external threats;

- Choice of optimal design decisions during the creation and improvement of PPS;
- Preparation of proposals for the administration of nuclear objects command (directing) of the security forces of nuclear objects to improve PPS and its individual structural elements, including decisions to optimize tactics of the security forces.

The main tool in assessing the effectiveness of PPS nuclear facility is a specially designed software "Vega-2." With this program you can assess and identify the full picture of the effectiveness of PPS, identify weaknesses, to reduce the likelihood of human error assumptions in the calculations and to simplify the procedure of effectiveness evaluation itself.

"Vega-2" software performs the following functions:

1. Construction of a formalized description of the object.
2. Automatic detection of possible ways to target the offending
3. Determining the effectiveness of PPS for each objective in two ways (analytical and simulation)
4. Representation of results of the assessment in the following ways:
 - displaying the numerical values of performance indicators PPS;
 - charting possible ways violator;
 - displaying information about critical paths;
 - recording results of the assessment.

For the most complete presentation and analysis of results of working "Vega-2" software the hypothetical nuclear facility was developed in.

As the object of scientific research we selected reactor - nuclear facility for the production of energy in a given mode and conditions of use, is located within a defined project area on which to carry out this purpose nuclear reactor complex and the necessary systems, apparatus, equipment and facilities with the necessary working personnel .

The object has a driveway and a railway track. Driveway is the most commonly used way to transport personnel to the job site. Railway track used to deliver fresh fuel and spent fuel sent to companies processing or disposal. The enterprise has an emergency exit.

The 3D - the scheme of hypothetical nuclear object

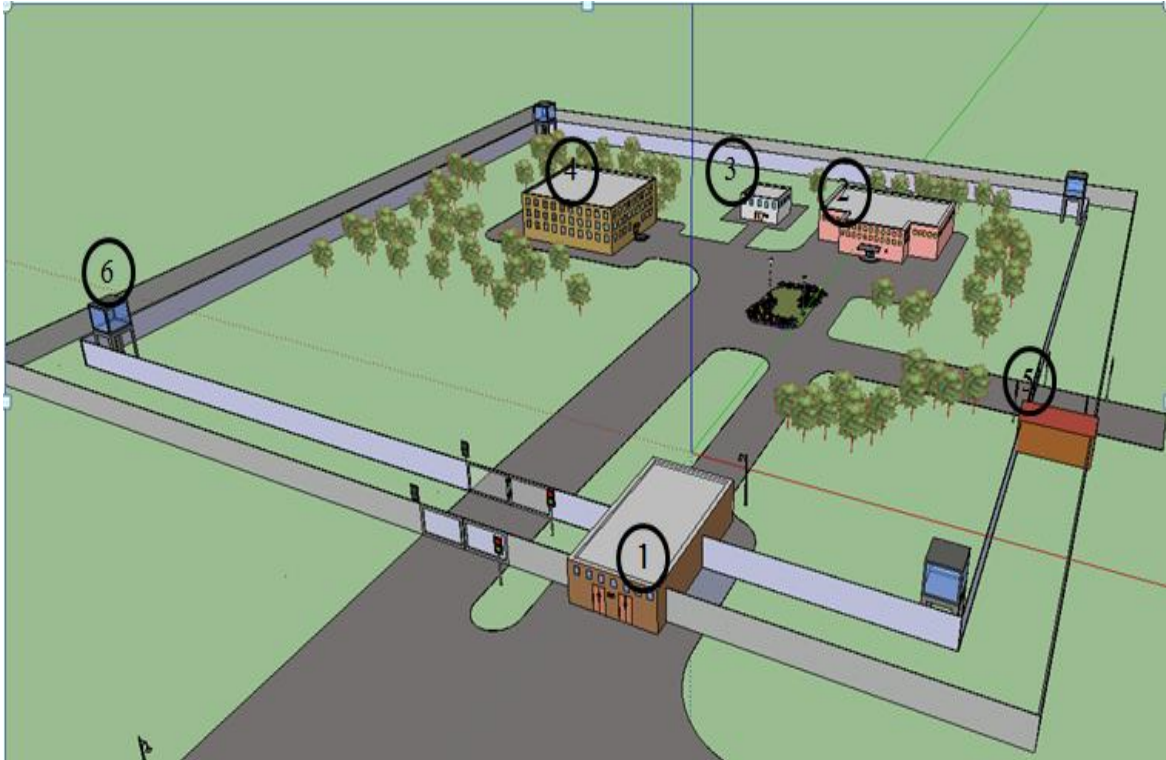

- 1 - АКПП and ЛКПП;
- 2- Reactor building;
- 3 - Management point;
- 4 - Building of the main warehouse;
- 5 - АКПП-2;
- 6 - Observation tower.

Currently, the design of various security systems are widely used methods of 3D modeling. We used this action in order to:

- 1. Visual representation of selected hypothetical object;
- 2. Visual effect with a detailed examination of the smallest details and arrangement of elements considered;
- 3. Obtain effective results and rapid elimination of defects, if found.

In this case, 3D modeling in the design of the various systems used for visualization of using software "Vega -2." The module is connected to the database by type of physical barriers and graphic description of the object module. Formalized description includes a description of the structure of the object and the location of items of physical protection as well as data from time to time to overcome the offender physical barriers and the likelihood of its detection times extension of the security forces to the borders of the physical protection of the offender and the times of movement of the security forces in sections.

Results

In order to create an effective system of physical protection in the established model visualization

hypothetical object in the 3D editor was built. With it analyzes the characteristics of the relative position of buildings, protected areas in the facility, placement of nuclear materials, elements of the complex of technical means of physical protection. Visibility resulting materials allows us to consider the possible route of offenders, changing tactics unauthorized actions in the restructuring of PPS.

Conclusion

On the basis of a formalized description of the object calculated module automatically determines the probable ways intruder (action script). For each path depending on the user evaluation of the effectiveness of the method automatically generates a graph of the situation or conducted simulation penetration offending object.

As a result of using three-dimensional graphics created specific hypothetical object, which gives a detailed description of all the necessary data to assess the effectiveness of using the software "Vega-2."

References

1. Meri Linn Garsiya. Design and assessment of system physical protection. World. – 2003 – p.392.
2. Systems of Accounting for Control of Nuclear Material, Vienna, May 2008
3. P.V.Bondarev, A.V.Izmaylov, N.S.Pogozhin, A.I.Tolstoy physical protection of nuclear facilities. Moscow: 6, 2004.
4. Bryukhovetskiy RI Technical means of protection perimeters. - Moscow: Research and Production Center Barrier 3, 2003.
5. Daniel M. Dobkin. The RF in RFID: Passive UHF RFID In Practice, Newnes 2008 ISBN 987-0-7506-8209-1, chapter 8
6. Bill Glover, Himanshu Bhatt, RFID Essentials, 2006 ISBN 056009445 page 43

Научное издание

**МЕТОДОЛОГИЯ ПРОЕКТИРОВАНИЯ МОЛОДЕЖНОГО
НАУЧНО-ИННОВАЦИОННОГО ПРОСТРАНСТВА
КАК ОСНОВА ПОДГОТОВКИ
СОВРЕМЕННОГО ИНЖЕНЕРА**

Сборник научных трудов
Международной научной молодежной школы

Статьи представлены в авторской редакции

Компьютерная верстка *А.А. Дерюгина*

**Зарегистрировано в Издательстве ТПУ
Размещено на корпоративном портале ТПУ
в полном соответствии с качеством предоставленного оригинал-макета**



Национальный исследовательский Томский политехнический университет
Система менеджмента качества
Издательства Томского политехнического университета сертифицирована
NATIONAL QUALITY ASSURANCE по стандарту BSEN ISO 9001:2008



ИЗДАТЕЛЬСТВО  **ТПУ**. 634050, г. Томск, пр. Ленина, 30
Тел./факс: 8(3822)56-35-35, www.tpu.ru