

Comparing methods of controlling unauthorized access to fiber-optic transmission lines

A V Yurchenko^{1,2}, A D Mekhtiyev^{1,3}, T N Shaigarayeva³, A D Alkina^{1,3}
and Y G Neshina^{1,3}

¹ National Research Tomsk Polytechnic University, Tomsk, Russia

² National Research Tomsk State University, Tomsk, Russia

³ Karaganda State Technical University, Karaganda, Kazakhstan

l_neg@mail.ru

Abstract. In present day telecommunication systems the topical problem is protection of the subscribers' personal data against possible thefts and hacking fiber-optic information transmission guide lines, as this causes a number of dangerous situations and problems. The attackers, in spite of the legislative framework for the information protection, are still trying to read information from a fiber-optic transmission line (FOTL). This possibility arises due to incorrect installation and configuration of error protection, unauthorized access to information is possible. This article discusses two methods of detecting unauthorized admission (unauthorized access). The results of the study using an optical laser radiation source and power meter, as well as a YOKOGAWA optical reflectometer are presented. As a result, it was concluded that the method of preventing unauthorized access at the wavelength of 1625 nm can be used, since continuous FOTL monitoring will not interfere with the traffic.

1. Introduction

In telecommunication systems there is the possibility of theft and hacking fiber-optic information transmission guide lines. To prevent this, it is necessary to strengthen protection of communication lines.

To implement the leakage channel, it is necessary to open carefully the cable sheath and to bend simply the fiber. At this, at the interface between the core and the sheath of the optical fiber (OF), the angle of incidence of the electromagnetic wave changes, which can lead to a partial exit of electromagnetic radiation from the light guide (Figure 1). This effect was described previously in literature [1-3]. We have already carried out studying the effect of additional losses changes due to various kinds of deformation of an optical fiber arising when bending [4]. There are a number of works dealing with similar topics [5-6].

The r radius of bending at which there will be observed radiation at the point of the fiber bending with the core diameter d that is connected with the destruction of the total internal reflection [6]:

$$r \geq d \frac{n_2}{n_1 - n_2} \quad (1)$$

where n_1, n_2 are indicators of the core and the sheath refraction.



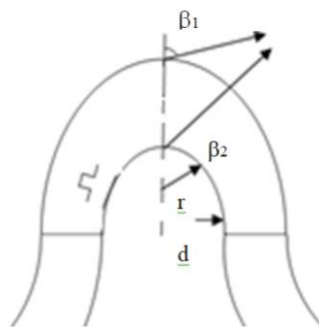

Figure 1. Leakage channel when bending with the r radius the fiber of the core diameter d' n1 is the angle of incidence; n2 is the angle of refraction.

Thus, the bending of the fiber leads to violation of the law of total internal reflection, which, in turn, leads to the flashing of the optical flow beyond the redistribution of optical fibers.

The known methods of detecting unauthorized access are divided into the following groups: the method of light transmission and the method of backscattering [7-9].

2. Research method

According to the first method, measurements can be carried out according to the methods of breakage and methods of inserted losses (Figure 2) [10].

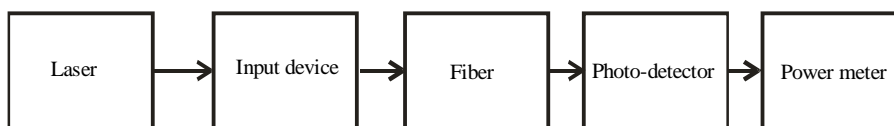

Figure 2. Light transmission method.

In this method, the light power will be determined at two points, for example, at A and B. Point B should be located at the far end of the fiber, and point A should be as close as possible to the beginning. The light power P is measured at the end of the line, and then at point B, but the input conditions between the light source (transmitter) and the fiber must be taken into account. Next, we find the attenuation coefficient α (dB/km) of the fiber that is calculated by the formula:

$$\alpha = 10Lg \frac{P(l_2)}{P(l_1)}, \tag{2}$$

Light is input and output at one end of the fiber using the backscattering method (Figure 3), and the information of the attenuation processes along the fiber can also be obtained.

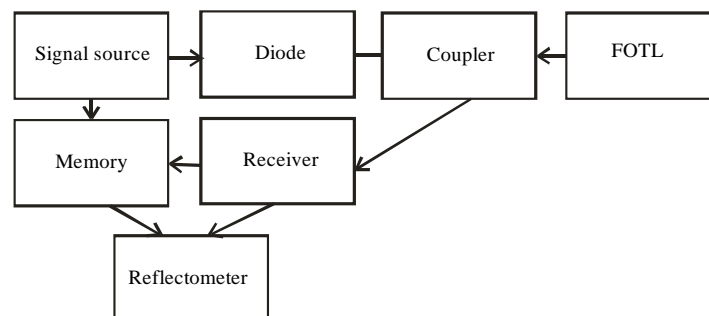

Figure 3. Backscattering method.

This method is based on Rayleigh scattering. Most of the power dissipation is distributed along the optical line, and only a small part is scattered back to the transmitter. This power, after it passes back through the fiber, will gradually attenuate. There is output and measured the remaining power using a directional coupler that is located in front of the fiber. According to this power and the time of passage through the fiber, a graph is plotted, on which attenuation is reflected along the entire length of the fiber.

The study is conducted by two methods. The first method is based on changing the properties of light as a mode passes through an optical fiber, the effect of light transmission. The following instruments are used: a radiation source optical laser and a power meter (Figure 4). The radiation source and optical wattmeter operate at the wavelength of 1310 nm and 1550 nm.

Measuring the total losses in the transmission line is implemented using the method of inserted loss during mechanical action on the optical fiber. The inserted loss method is used to measure the total loss in the transmission line. Due to the fact that the ends of the line are usually separated by a long distance, in the course of such measurements it is necessary to perform additional calibration of the laser and photo-detector module. The photo-detector unit of the optical tester at point A is used to measure the reference value of the radiation power of the laser unit, and the photo-receiver module of the optical tester at point B measures the radiation power transmitted through the communication line [11-12].



Figure 4. The exterior of the radiation source optical laser.

The light power is measured at the far end of the test fiber, and then is compared with the light power at the end of a short piece of fiber. Such a segment of the fiber serves as a reference and should be comparable to the fiber under test in structure and characteristics.

To do this, a constant signal level (CW mode) and a wavelength are set at the radiation source.

1) With a power meter set to

wavelength $\lambda_1 = 1310$ nm the loss level $\alpha_1 = - 3.90$ dB

wavelength $\lambda_2 = 1550$ nm loss level $\alpha_2 = - 4.3$ dB.

2) We introduce an unplanned connection and measure the losses again:

at a wavelength of $\lambda_1 = 1310$ nm and the level of losses $\alpha_1 = - 4.31$ dB

at the wavelength $\lambda_2 = 1550$ nm and the loss level $\alpha_2 = - 4.27$ dB

The method of light transmission gives a general picture of the loss, but it is impossible to find a place of connection.

In the course of the study there have been obtained the methods of information processing used by foreign scientists [10-12].

3. Backscattering method

This method is based on the backscattering effect. The studies were carried out using a YOKOGAWA optical reflectometer (Figure 5) and two coils with FOTL lengths $l_1=2.18$ km and $l_2=2.99$ km, respectively. The patchcord is placed between two coils.



Figure 5. Optical mini-reflectometer YOKOGAWA.

The measurement parameters are as follows: wavelength $\lambda_1 = 1310$ nm and $\lambda_2=1550$ nm, the time $t=15$ s, the pulse length is 275 ns, the turn diameter is 17.9 mm.

The fiber length determined by the reflectometer is:

$$l = K_{\text{ref}} \frac{\Delta t}{2} * \frac{c_0}{\eta_D}, \quad (3)$$

where l is the length of the fiber, km;

Δt is the time difference between the peaks of the initial and final pulses, s;

η_D is an actual group indicator of the core glass refraction;

K_{ref} is the reflection factor;

c_0 is the light velocity in vacuum 300 000 km/s [10].

We have obtained the following research results for method 2.

Let's consider Figure 6 for the wavelength $\lambda_1=1310$ nm without any intervention in the system. In this Figure it is seen that the loss is -1.830 dB.

Figure 7 shows the trace with an external impact on the system. From Figure 7 it can be seen that the loss has increased dramatically to 1.95 dB. We also measure the place of the external impact, which was 2.08 km.

Let's consider Figure 8 for the wavelength $\lambda_2=1550$ nm without any intervention in the system. In this Figure it is seen that the loss is -1.50 dB.

Figure 9 shows the trace with an external impact on the system. From Figure 9 it can be seen that the loss has increased dramatically to 4.63 dB. We also measure the place of external impact, which amounted to 2.09 km.

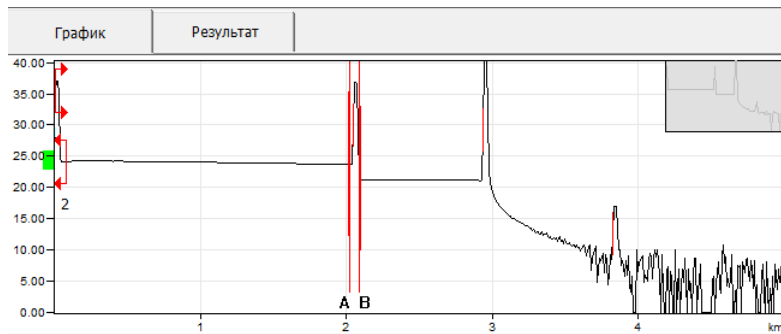

Figure 6. Reflectogram for the wavelength $\lambda_1 = 1310$ nm.

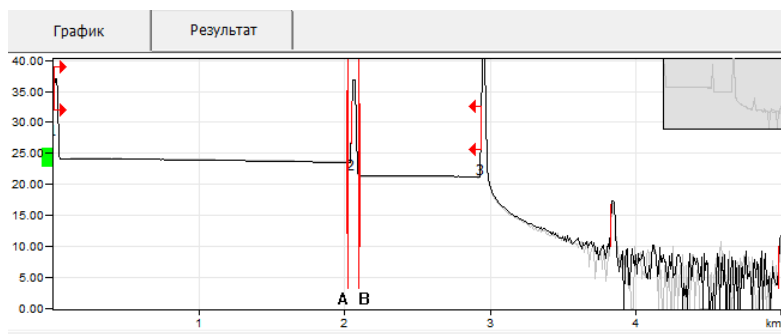

Figure 7. Reflectogram for the wavelength $\lambda_2 = 1310$ nm with external effect on the system and the place of unauthorized access.

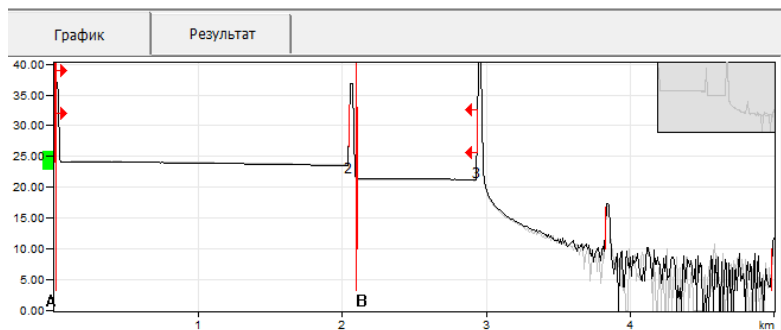

Figure 8. Reflectogram for the wavelength $\lambda_1 = 1550$ nm.

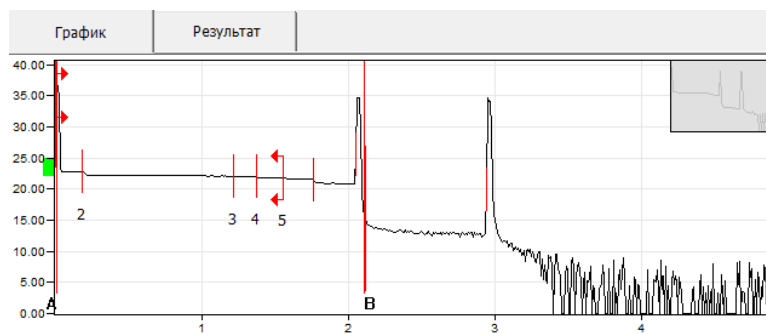

Figure 9. Reflectogram for the wavelength $\lambda_2 = 1550$ nm with external effect on the system and the place of unauthorized access.

4. Conclusions

Thus, the studies have shown that, by the method of light transmission, losses increase with unauthorized access, but it is not possible to determine the location of the information being collected. The backscattering method also shows an increase in losses during unauthorized access, but it is possible to determine the connection point of the attacker.

It can be noted that the information can be removed from an optical fiber. According to the test results, it can be concluded that increasing the losses at a longer wavelength suggests that it is better to detect UAA at the wavelength of 1625 nm, since the FOTL continuous monitoring will not interfere with the traffic.

References

- [1] Liu X, Wang C, Liu T, Wei Y, Lv J 2009 Fiber Grating Water pressure sensor and system for mine *ACTA Photonica Sinica* **38** 112-114 DOI:10.3390/s16101759
- [2] Kumar A, Kumar D, Singh U K, Gupta P S, Shankar G 2011 Optimizing fibre optics for coal mine automation *International Journal of Control and Automation* **3** 63-70 DOI: 10.1007/s12404-010-0401-3
- [3] Naruse H, Uehara H, Deguchi T, Fujihashi K, Onishi M, Espinoza R and Pinto M 2007 Application of a distributed fibre optic strain sensing system to monitoring changes in the state of an underground mine *Measurement Science and Technology* **18(10)** 3202-10 DOI: 10.1088/0957-0233/18/10/S23
- [4] Yurchenko A V, Mehtiyev A D, Bulatbaev F N, Neshina E G and Al'kina A D 2018 The Model of a Fiber-Optic Sensor for Monitoring Mechanical Stresses in Mine Workings *Russian Journal of Nondestructive Testing* **7** 61-6 <https://doi.org/10.1134/S1061>
- [5] Gorlov N and Eyrikh V I 2012 The main tasks of monitoring modern fiber-optic transmission lines *Proceedings of the International scientific conference* **2** 68-70
- [6] Yurchenko A V, Gorlov N I, Mekhtiyev A D, Kovtun A A 2016 Research of the additional losses occurring in optical fiber at its multiple bends in the range waves 1310nm, 1550nm and 1625nm Long *IOP Science Journal of Physics* **671** DOI:10:1088/1742-6596/671/1/012001
- [7] Chotchayev H O 2016 Control of the stress-strain state of a mountainous massif by soundometric and geophysical methods *Geology and Geophysics of Southern Russia* **3** 129-140
- [8] Buimistryuk G Ya 2011 Principles of building intelligent fiber-optic sensors *Foton-Express* **6(43)** 38-9
- [9] Buimistryuk G 2013 Fiber-optic sensors for extreme conditions *Control engineering Russia* **3(45)** 34-40
- [10] Kim S T, Park Y-H, Park S Y, Cho K, Cho J-R 2015 A sensor-type PC strand with an embedded FBG sensor for monitoring prestress forces *Sensors (Switzerland)* **15(1)** 1060-70 DOI: 10.3390/s150101060
- [11] Liu T, Wei Y, Song G, Li Y, Wang J, Ning Y, Lu Y 2013 Advances of optical fiber sensors for coal mine safety monitoring applications *Proceedings of the 2013 International Conference on Microwave and Photonics* 102-111
- [12] Yiming Zh, Nong Zh and Guang-yao Si 2016 A fiber bragg grating-based monitoring system for roof safety control in underground coal mining *Sensors (Switzerland)* **16(10)** 112-7 DOI: 10.3390/s16101759