

# Electron beam diagnostics tool based on Cherenkov radiation in optical fibers

A V Vukolov, A I Novokshonov, A P Potylitsyn, S R Uglov

Department of Applied Physics, National Research Tomsk Polytechnic University, 30 Lenina Street, Tomsk, Russia

E-mail: novokshonov@tpu.ru

**Abstract.** The results of experimental investigations of Cherenkov radiation in optical fibers with 0.6 mm thickness which were used to scan an electron beam of 5.7 MeV energy are presented. Using such a technique for beam profile measurements it is possible to create a compact and reliable device compared to existing systems based on ionization chambers.

## 1. Introduction

A wide application of electron accelerators with energy  $\sim 10$  MeV in different fields (essential for medical treatment) determines a necessity for beam parameter diagnostics in on-line mode. One of these important parameters is the transverse beam profile. The most widespread technique of transverse beam profile measurement is based on detection of bremsstrahlung generated by the electrons passing through a thin metal wire [1, 2]. Such a diagnostics device has several disadvantages such as weak sensitivity and inability of gamma beam diagnostics.

There is another technique for beam diagnostics, which is used in intraoperative therapy, based on the ionization chamber. But this device has insufficient spatial resolution exceeding 1 mm [3, 4]. One can use X-ray films for beam profile diagnostics to reach submillimeter resolution [5], but such a technique is an off-line one.

The development of the new approaches for beam profile measurements is the actual task.

In the works [6-8] the feasibility of Cherenkov radiation in glass fibers for high energy beam diagnostics was demonstrated but application of such a technique for moderate energy electron beams was lacking. In our work the glass fibers were used for a few MeV energy electron beams with submillimeter spatial resolution. This technique is based on Cherenkov radiation detection which is generated by an electron beam in a bulk of 0.6 mm thickness optical fiber. The fiber was covered by the scattering lead foil to ensure electrons with broad angular distributions overlapped the Cherenkov angle inside the fiber.

## 2. Experimental setup and theoretical estimations

Investigations of characteristics of the developed device were carried out at the microtron MI-6 of Tomsk Polytechnic University. The main microtron parameters are shown in table 1 and the schematic of experiment is shown in figure 1.



**Table 1.** The main microtron parameters.

Parameter	Value
Energy of electrons, MeV	5.7
Monochromaticity	less than 3 %
Spill frequency, Hz	25
Duration of the macropulse, $\mu\text{s}$	0.5
Number of bunches in a macropulse	$\sim 10^4$
Bunch population	$\sim 10^7$

Cherenkov radiation was generated by the electron beam inside the fiber with 0.6 mm thickness. Construction of a fiber represents a glass optical wire with 0.6 mm thickness with a plastic outer layer. This fiber was wrapped by a lead foil with 0.2 mm thickness. So the total diameter of optical cable was  $\sim 2$  mm. Registration of radiation was carried out by two different photomultipliers (PMT): silicon PMT Sensl MicroSB and vacuum PMT.

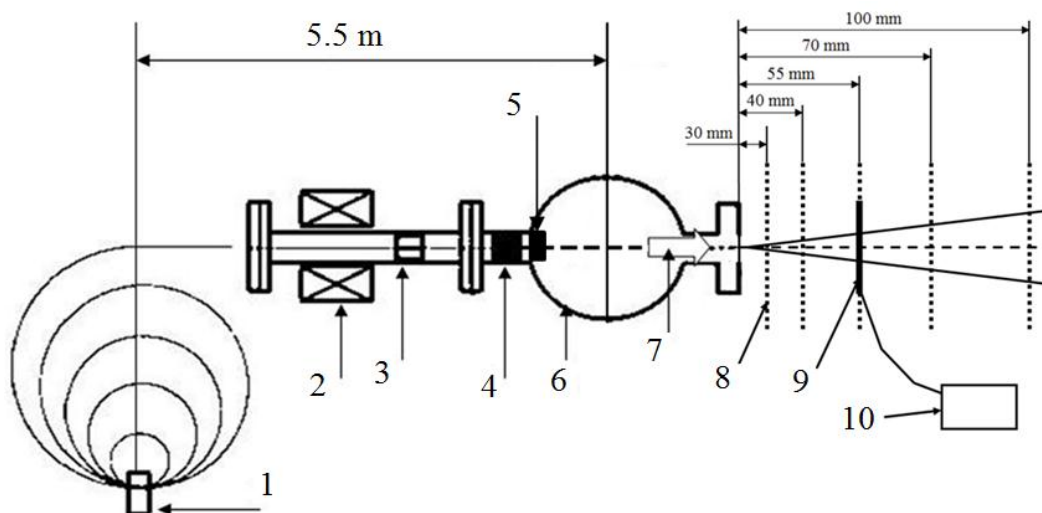

**Figure 1.** Scheme of the setup: 1 – microtron injector; 2 – focusing magnet; 3 – beam collimator; 4 – inductive sensor; 5 – second beam collimator; 6 – experimental chamber; 7 – electron beam; 8 – X-ray films (dotted lines); 9 – fiber; 10 – silicon/vacuum PMT.

As shown in figure 1, the electron beam passes through the focusing magnet, beam collimator, inductive sensor, second beam collimator with 1 mm diameter, experimental chamber, and then it goes from vacuum chamber into air through Al window with 100  $\mu\text{m}$  thickness. There were used X-ray films on different distances from the output window. X-ray films were positioned at a range of distances from the output window. Using the same range of positions as for the X-ray films, a fiber was located and moved perpendicular to the electron beam axis in the horizontal or vertical direction to measure the beam profile. Such a technique allowed to measure beam profile and then to compare it with measurements using X-ray films.

It is well-known that Cherenkov radiation is generated in a cone with axis that lies on the electron trajectory. Opening angle of such a cone  $\theta_{\text{ch}}(\lambda)$  is [5]:

$$\cos\theta_{\text{ch}}(\lambda) = \frac{1}{\beta n(\lambda)}, \quad (1)$$

where  $\beta = v/c$ ,  $\lambda$  is wavelength,  $n$  is the refraction index of the medium.

Number of photons, generated by one electron per length unit, can be estimated also [9]:

$$\frac{d^2N}{dx d\lambda} = 2\pi\alpha z^2 \sin \theta_{ch}(\lambda) \frac{1}{\lambda^2}, \quad (2)$$

where  $x$  is a particle path,  $\alpha$  is the thin structure constant,  $z$  is a charge of the particle.

Estimation of the Cherenkov photons yield in visible range (from 400 nm to 700 nm) in glass is about 30 photons per one electron and per 1 mm path. The photon outgoing angle in glass is  $\theta_{ch} \approx 46^\circ$  (refraction index  $n = 1.47$ ). The number of transition radiation photons is about  $10^3$  times less than the Cherenkov photons yield in 1 mm thickness glass.

The piece of the fiber which was located on the electron beam axis can be inclined relative to the beam axis. With the inclination the number of Cherenkov photons captured in total reflection angle is increased thereby the signal rises.

The length of the fiber was 2 m and it was connected by one of its ends to the PMT.

The main parameters of the silicon PMT are shown in table 2 [10].

**Table 2.** The main parameters of silicon PMT Sensl MicroSB.

Parameter	Value
Square of PMT sensitive area, mm <sup>2</sup>	6×6
Number of pixels	18980
Spectral sensitivity, nm	from 300 to 800
Gain coefficient	$3 \times 10^6$
Efficiency of photon registration (420 nm)	47%
Supply voltage, V	24.5

Additional advantages of such a PMT are its compact size, insensitivity to magnetic field, low supply voltage compared to vacuum PMT, mechanical reliability, weak reaction on ionizing radiation and possibility of operation in vacuum.

The main parameters of the vacuum PMT are shown in table 3.

**Table 3.** The main parameters of vacuum PMT.

Parameter	Value
Diameter of sensitive area, mm	25
Spectral sensitivity, nm	from 300 to 850
Gain coefficient	$10^6$
Light sensitivity of photocathode, A/lm	$8 \times 10^{-5}$
Sensitivity of photocathode for 410 nm wavelength, A/W	$4 \times 10^{-2}$
Supply voltage, kV	1.5

The signal which was registered by the PMT, was then treated by analog-to-digital converter (ADC) for digitizing and for program processing.

### 3. Results of experiments

Oscillograms of the signal from the vacuum and silicon PMTs are presented in figure 2. These oscillograms were measured with different fibers: 5 mm thickness fiber for the vacuum PMT and 0.6 mm thickness fiber for the silicon PMT. One can see that the amplitude of signal from silicon PMT even with the thinner fiber is more than two times higher than the amplitude of signal from vacuum PMT. Such a low level of signal didn't allow us to use the vacuum PMT in our measurements.

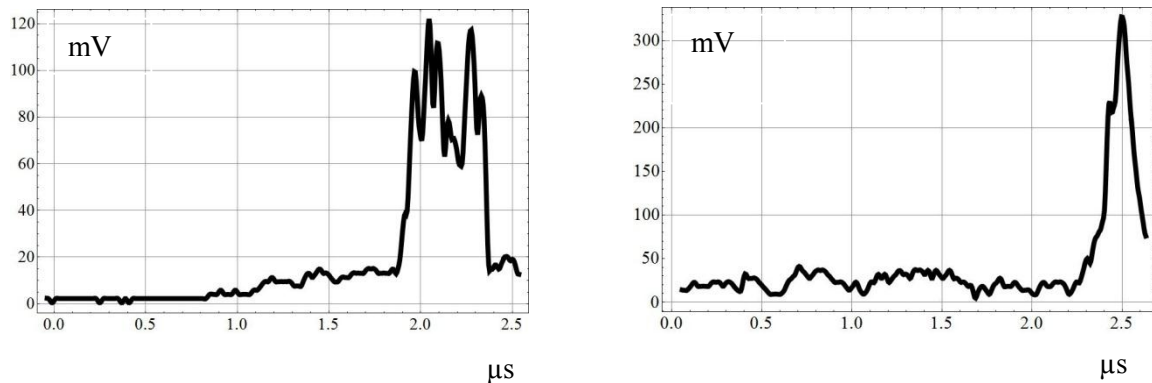

**Figure 2.** Oscillograms of signal from the vacuum (left one) and from the silicon (right one) PMT.

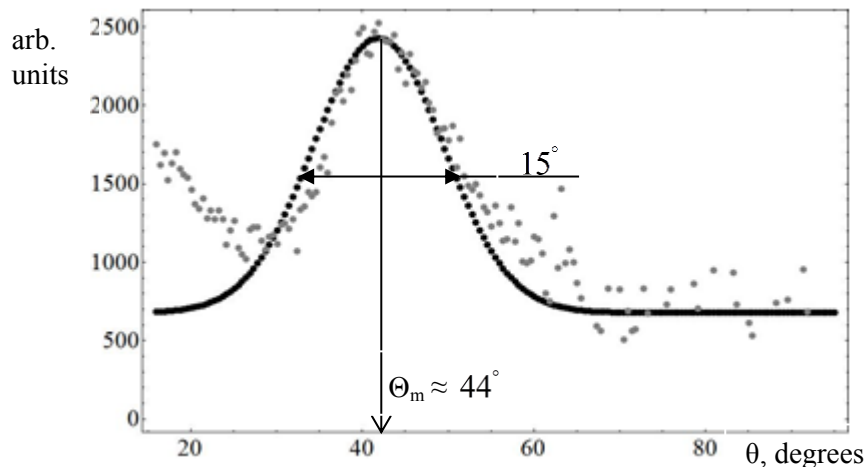
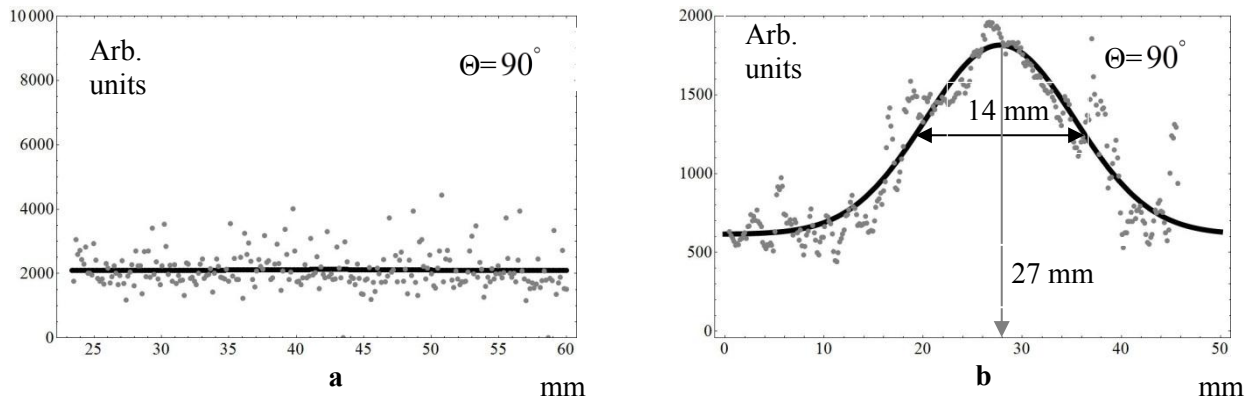

**Figure 3.** Orientation curve. Grey points – experimental data, black points – fitting of experimental data by normal distribution.

At the first stage of our experiment we have measured orientation curve which is represented in figure 3. The orientation curve was measured by inclination of the fiber relatively to the electron beam axis in horizontal plane. The angle in figure 3 is the angle between fiber and electron beam axis. The cause of high intensity in small angle region is that fiber was held by a metal holder and halo of electron beam interacted with the holder for small inclination angle. The exposure time at each angle was 2 seconds (50 pulses). An averaging of the PMT signal was carried out during 50 pulses.

The orientation curve gives information about the angle of fiber inclination corresponding to the maximal signal and about possibility of the electron beam diagnostics without special scatterer (lead foil) when the inclination angle of the fiber equal to  $90^\circ$ . From figure 3 one can see that when the fiber inclination angle is close to  $90^\circ$  the intensity of Cherenkov radiation is more than 10 times less than in maximum ( $44^\circ$ ). For increasing of Cherenkov radiation yield for  $\theta = 90^\circ$  the additional scatterer (lead foil) was used.

In figure 4 experimental measurements of the transverse beam profile are shown with 0.6 mm thickness fiber without scatterer (figure 4a) and with the lead foil (figure 4b) when the distance between the fiber and output window was 70 mm. From figure 4 one can see that such a beam diagnostics is useless in the case when there is no scatterer.



**Figure 4.** Transverse beam profile: **a** – without scatterer; **b** – with scatterer.

As shown in figure 1, measurements of beam profile were carried out using X-ray films Gafchromic EBT-3 with distances between the films and output window  $L = 30, 40, 55, 70$  and  $100$  mm. The details of the X-ray films treatment are described in the work [11]. The results from these measurements were compared with results obtained with the fiber. One of the electron beam profiles obtained by X-ray film is shown in figure 5. The beam profile measured for  $70$  mm distance is shown (figure 5a), as well as its horizontal (figure 5b) and vertical (figure 5c) distributions.

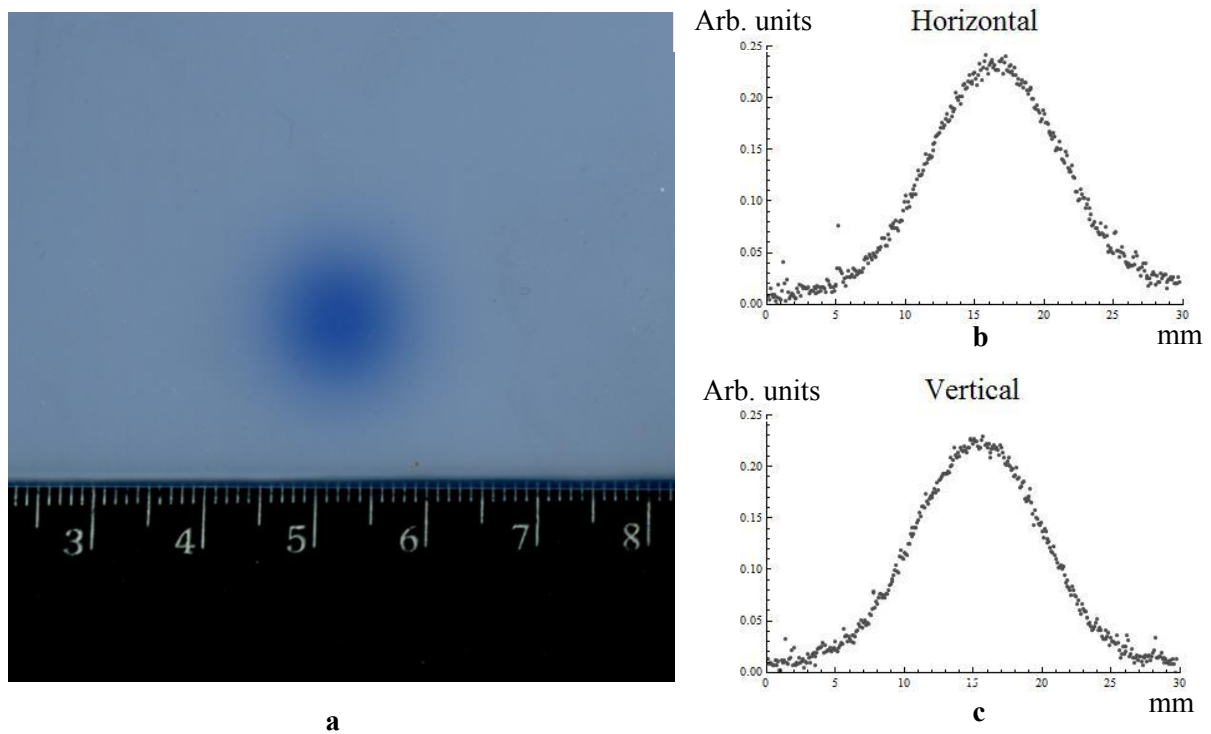

**Figure 5.** Electron beam profile for  $70$  mm distance: **a** – X-ray film; **b** – horizontal distribution; **c** – vertical distribution.

In figure 6 horizontal profiles of the electron beam for different distances from the output window measured using the X-ray films are shown.

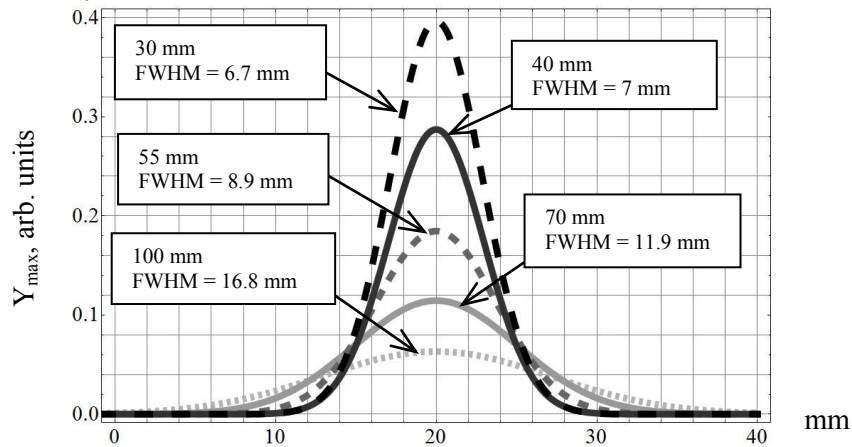

**Figure 6.** Normal distribution fits for horizontal profiles of electron beam measured by X-ray films.

Figure 7 demonstrates horizontal profiles of the electron beam measured by the fiber with the silicon PMT. Profiles measured by the fiber and profiles measured using the X-ray films are in good agreement. The difference between these two techniques is about 3 mm, which can be explained by the fibers diameter with taking into account a scatterer thickness.

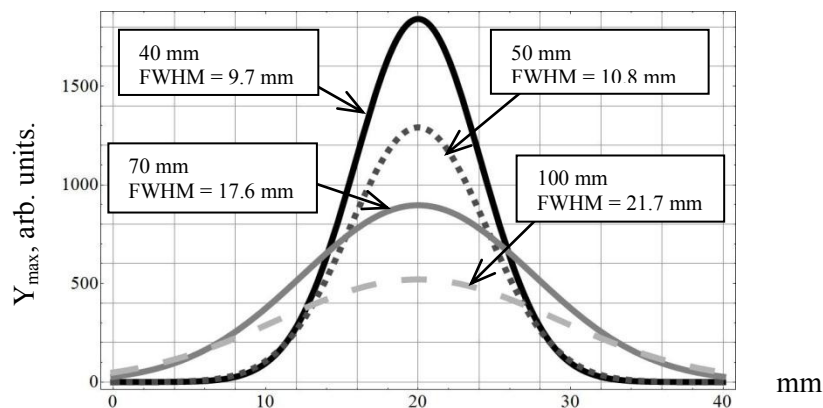

**Figure 7.** Normal distribution fits for horizontal profiles of electron beam measured by fiber with the silicon PMT.

Experimental dependencies of the transverse beam profile on a distance  $L$  between detector and output window measured by X-ray films and fiber, and also simulation results obtained in PCLab (manual for this program can be found in [12]) are presented in figure 8. Experimental dependencies are fitted by polynomials.

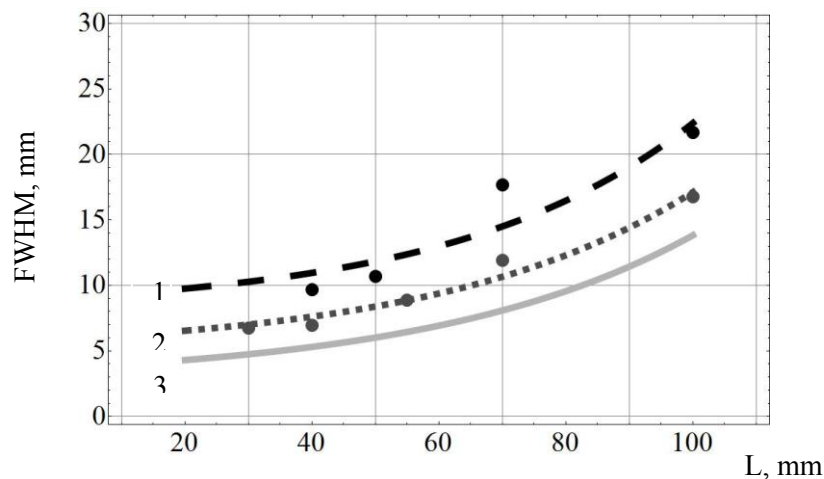

**Figure 8.** Comparing of experimental results obtained from X-ray films, from fiber and result of simulation curve: 1 – experiment with fiber curve; 2 – experiment with X-ray film curve; 3 – simulating curve using Monte-Carlo technique.

#### 4. Conclusions

Results of the experiments demonstrate a feasibility of transverse electron beam profile measurements for a few MeV energy and low intensity beams using Cherenkov radiation generated in a bulk of optical fibers. The technique proposed in this work has simple realization, small sizes and good signal/noise ratio. The main advantage of this technique is the perpendicular orientation of the fiber relative to the electron beam axis. It means that there are no distortions of experimental results in comparison with the case when the fiber is inclined at the Cherenkov angle  $\theta_m$ . The proposed technique allows to measure beam profiles in on-line mode.

#### Acknowledgements

This work was partially supported by the Russian Ministry of Education and Science within the program “Nauka” Grant № 3.709.2014/K.

Authors would like to acknowledge Dr. L. Sukhikh for helping in X-ray film data treatment.

#### References

- [1] Rawnsley W R, Ries T C, Mackenzie G H 1987 *Proc. PAC*
- [2] Steibach C, Rooij M van A, 1985 *J Trans. Nucl. Sci.* **5**
- [3] Almond P R, Biggs P J, Coursey B M 1999 *J Medical Physics* **26** 1847
- [4] Low D A, Moran J M, Dempsey J F et al. 2011 *J Medical Physics* **38** 1313
- [5] Schiaparelli P, Zefiro D, Massone F and Tacichi G 2010 *J Medical Physics* **37** 3510
- [6] Baudrenghien P and Mastoridis T 2012 *Proc. Advanced Beam Dynamics Workshop on High-Intensity and High-Brightness Hadron Beams* 565-569
- [7] Wulf F and Korfer M 2009 *Proc. DIPAC2009* 411
- [8] Murokh A, Agustsson R, Boucher S, Frigola P, Hodgetts T, Ovodenko A, Ruelas M and Tikhoplav R 2012 *Proc. IPAC2012* 996
- [9] Landau L D and Lifshitz E M 1984 *Electrodynamics of Continuous Media*.
- [10] <http://sensl.com/downloads/ds/DS-MicroJseries.pdf>
- [11] Sukhikh E, Sukhikh L and Malikov E 2015 *Advanced Material Research* **1084** 572
- [12] Bespalov V I Programm package EPHCA for statistic modeling of photons and charged particles radiation field <http://portal.tpu.ru/SHARED/b/BVI/pclab>